







Site Index of Frank.Germano.com

[Who was NIKOLA TESLA, and what were his greatest inventions?](#)

Extensive information on Nikola Tesla, with emphasis on his "Magnifying Transmitter" invented to offer the world wireless transmission of electrical energy to any point on the planet. Extensive in-depth articles, notes, archival footage and excellent pictures. Includes period newspaper and magazine articles on Tesla's life and work. A very detailed, comprehensive webpage.

As companion articles:  [A Machine To End War](#) and  [The Wonder-World Created By Electricity](#) and  [Nikola Tesla On His Work With Alternating Currents](#)  [Tesla's Radiant Energy System](#)  [Tesla's Earthquake Machine](#)  [Tesla Quotes!](#)

["Frank Germano and Tesla's Bladeless Disk Technology](#)

The definitive page and resource for understanding or learning about the Bladeless Disk, Vortex and Implosion Technologies used in all of our products. Our products are based on the original inventions of Viktor Schauburger and Nikola Tesla created nearly a century ago. Applications, descriptions and details of each engine and system is presented for the reader or potential investor.

[Digital Pictures and Engineering Reports on our Tesla-type Bladeless Disk Turbine and Pump - the BDT](#)

 **NEW! [Our Tesla & Schauburger-based Bio-submarine, Bio-Airship, and Biosphere Blimp](#)**: I have expanded our research into aerial transportation and underwater crafts. This page will let you take a "sneak peak" at what we've come up with.

[The Lost Inventions of Nikola Tesla](#)

This page will give you some surprising information about Tesla, the disk turbine, the magnifying transmitter, high-frequency lighting, the Tesla Coil, and more. Also included is a very "short winded" biography on Tesla.

[The Tesla Bladeless Boundary Disk Turbine \(Historical Archive\)](#)

Offers an in-depth analysis of the "Tesla Turbine," and the "Tesla Pump," both in their design, and the history of their development. Included are some great period articles from Nikola Tesla, on his construction of the turbine itself, as well as his future plans for it. This page is designed to provide a thorough understanding of the principles of operation of the Tesla bladeless disk boundary layer turbine engines and pumps.

[Researching A Shockwave Tesla Turbine](#)

[A Thermo-Pneumatic Tesla Turbine Locomotive](#)

[Tesla Tunguska; Free Energy](#)

 [the Tunguska Explosion](#) a possible explanation to this astounding event.

 [Tesla's "Fuel less Generator"](#) exactly what was this amazing invention? A theory is presented.

 [Physics of the "Fuel less Generator"](#) an in-depth description of the device used by permission; compliments, **Dr. Oliver Nichelson**

[Nikola Tesla: The Greatest "Hacker" Of All Time?](#)

What would happen if Tesla's "Magnifying Transmitter" were to be built, and operated today? This excellent page offers an interesting opinion. Also:  [Tesla's Magnifying Transmitter: An Historical Perspective](#). This compilation of information offers Tesla's own words on exactly what he was trying to accomplish with this amazing device - his life's dream. Free, unlimited, wireless, electrical power to any point on the planet - pretty darn cool. If you would really like to learn what Tesla was trying to offer mankind, please read this section.

[Tesla's "Black Box"](#)

In 1931, Tesla took an automobile, with its internal combustion engine removed, installed an AC electric motor, connected the wires from the motor to his "black box," and ran the auto for days...with nothing else hooked up for power. A great period historical article.

[Who was Viktor Schauberger ? The "Water Wizard":](#) [[PAGE ONE - historical info](#)] [[PAGE TWO - the power of water](#)] [[PAGE THREE - the inventions!](#)] [[PAGE FOUR - implosion](#)] [[Implosion Technology Report](#)] [[Vortex Science!](#)]

The information contained on the five pages will amaze you. Naturally, most of this site is geared towards presenting the history behind, and the inventions of Nikola Tesla. I began studying the Schauberger theories as a way of incorporating two similar, yet opposite avenues of thinking. **Viktor Schauberger**, with his innate understanding of the workings of nature, and in particular - WATER - and the immense energies contained "in" water, was, quite probably one of the most underestimated, and misunderstood men of the last century. There now is a resurgence into looking at his theories...with the aim of incorporating his ideas into working models. After you view this section, pick up at least one of the six books offered. The ideas, and theories can radically alter the way we presently view, and ultimately harness the power of the "living energies" contained in "living water." Check out all five pages; As the "wind-up" to the four page series, "Implosion Technology" takes a look at a report that will be generated in the hopes of forcing our modern society, governments and big businesses to take a direct look at the technology presented.

[APPLIED VORTEX SCIENCE](#): Practical Schauberger technology applied to today.

[Vortex Theory: Water Power, and Water Power II](#): utilizing water as a means of propulsion for the Tesla Turbine.

Detailed information on the use of water power, from our nation's natural rivers, to drive Tesla-type turbines for electrical power generation. The theories of Dr. Victor Schauberger, and Dr. Nikola Tesla's are amplified. Further Schauberger theories are contained in the companion page: [Water Power II](#)

["Whirlpower!"](#)

Perhaps one of the most fantastic applications of vortex theories in existence. The concept of "Whirlpower" was coined and created by Mr. David Dennard in the early 1990's. Since David's untimely death, many have theorized that this concept could, in fact, actually be the "holly grail" of free energy production.

[NEW ! The Frank.Germano.com On-Line Bookstore](#)"

Outstanding sources of information and books, for further research, from "[Amazon.com](#)". This is an extensive listing of ALL the books that Amazon carries, or has access to, from their database. I highly doubt that there is a more thorough resource on the web pertaining to Nikola Tesla, Viktor Schauberger, or building your own passive solar "off-grid" home. The page consists of six distinct sections. I've also added the only six remaining and published books, and one very good video, on Viktor Schauberger. I've included some great books on energy efficient living, house plans, "[Earthship](#)" [bio-techture](#), Natural Home - "[Archetara](#)" [high thermal mass](#) - "[HTM's](#)", passive solar homes, types of alternative energy construction (rammed earth, straw bale, solar and passive solar, etc.) and a few books from my dear friend and architect/author [Charles G. Woods](#). Hope you enjoy the selections. Buy some books...absorb the info...change the world for the better... and live in your own energy efficient, environmentally friendly house. What a concept. PS: I also have every book that is listed...what a library!

["How Can YOU Help Us?!"](#)

As bold as this sounds, you CAN in fact, HELP us. If you truly wish to see this amazing technology become commercially available, visit this page. It was Tesla's and Schauberger's dream - creating a "new tomorrow", and now I am trying to keep that dream alive... Thanks.

[Christian Study, Links, Information & Resources](#)

This page has an extensive listing of links to Christian Websites. It includes my favorite "bakers dozen," and some of my personal favorite sections from E.W. Bullinger's "Appendixes of the Companion Bible." Also: "[What is Christmas Day?](#)", "[The Serpent Of Genesis III](#)", & "[The Cross](#)", and "[The Two Great End-Age Prophecies](#)".

An entire webpage of Christian Bible study topics is presented: | [Garden of Eden](#) | [Three World Ages](#) | [the Rebellion of Satan](#) | [What is the Mark of The Beast ?](#) | [Rapture of the Church Bible study](#) | [Rapture of the Church: the LIE that leads to the Beast](#) | [Christmas](#) | [Gentile and the Jew](#) | [The Two Figs](#) | ... All work, compliments to my favorite teacher and pastor, [Pastor Arnold Murray of the "Shepherd's Chapel"](#), Gravette, Arkansas. Thank you for opening my eyes, my ears and my heart to the true meaning contained in the Word of God.

[\[HOME\]](#)

THREE Products That I Endorse are the "[Electron 3 & 4 Living Water Machines](#)" and the

"Wellness Filter" line, (each unit representing a unique approach on water revitalization and purification ala Viktor Schaubberger's prior work, and both offered through "FutureTech Today," and "Infinity Water™" from Ms. Nora Kosztolanyi. Coming from where I've been with a diagnosis of cancer, to now cancer-free...I stand by these products and their as yet unproven health effects.



FutureTech Today introduces the Electron 3 & 4 Living Water Machine. This machine is being marketed through Future Tech Today, made by "For Health Reasons" of Chicago Illinois, USA. (makers* of quite probably the best water filtration system, based on victor Schaubberger's ideas, of course, on the planet!
Purer Distilled Drinking Water:

When vapor turns to rain, it passes through temperature gradients where the temperature is continually changing with oxygen. This process stretches and contracts the H bonds that hold the molecules together...this creates ENERGY! Plant diseases are caused by viruses and bacteria, and our method of autoclaving them, using INTENSE HEAT, DESTROYS THEM (NOT just boiling). The research chemist and others spent thousands of dollars on every product on the market, and ONLY OUR METHOD prevented the diseases in plants and caused incredible growth by just dropping plant buds in the water. Root growth 2 1/2 inches long compared to 1/8 of an inch in any of the others during the same time frame...even compared to water with nutrients added to the it!! This test was REPEATED over a period of three YEARS ...so there is no mistake!. The BOTTOM LINE is that today's ordinary water is DEAD! Why would ANYBODY want to use DEAD water, and yet most people do! If you can afford the rather steep price of their units, it is well (no pun intended!) worth the price, from personal use, on my end.

*The company that originally produced this unit is listed below - "For Health Reasons" of Chicago, IL.

The company SELLING (marketing) the unit is **FutureTech Today**... "Future Tech Today was founded in 1998 with ambitions to break the latest energetic healing technologies to the general public while maintaining a research and development program allowing them to bring tomorrow's technology today. The idea was to represent the latest technological research in the fields of energetic medicine, water vitality, and EMF (electro-magnetic field) protection products. They represent products and technologies from all over the world, many of which are in very early stages of production or still in research phases; in this way they give the general public a preview of technologies to come..." (from their website, and used here for endorsement sake) FDG



FutureTech Today introduces the Wellness Filter! This is the **Wellness Filter®**, and comes in various sizes to suit individual needs. In my humble opinion - it's the best on the market, today. Pricy, but well worth it. Again, this product is offered through FutureTech, Today. For website info, use either their link - **FutureTech Today** - or <http://www.wellness.com.au> (If you go to wellness.com.au directly, you can even become an associate, an affiliate, or a partner-type program with them if you meet their strict company requirements).

"The Wellness Filter® offers you and your family a quality of water that Nature has provided to only a select few. By using natural purification processes in combination with advanced technology, the Wellness Filter® produces what many believe is the best drinking water on Earth. The Wellness Filter® not only removes harmful contaminants but it also enhances the water through a patented process that creates a quality of water beyond the reach of conventional water filters. Clean water plays a vital role in your health, fitness and appearance..." (from the FutureTech Today website).

INFINITY WATER - Infinity Water® is a Perfect Living Water based on the most advanced scientific understandings of

vibration and energy as the foundation of living chemistry, where as the mainstream medical model is still caught up in the mechanistic limitations of Newtonian Physics. In 21st Century of advancements in physics and quantum mechanics it is clear that the status quo maintained by the drug companies and mainstream medical doctors is totally out of date. Based on the pioneering work of the late Viktor Schauberger...the first words out of my "significant other's" mouth was - "snake oil" - until she saw the clear effect on my blood work from the most recent Doctor/Hospital visit. Check out the website for yourself. At the very least, if you are curious, try it...if you have a positive experience as I have, let me know via email and I will attempt to push this Infinity Water even more through this website. FDG.



copyright & patent info

"Frank.Germano.com" Copyright © 2004,
Website Content may not be reproduced in any form without permission:
Website copyright © Frank.Germano.com - 1999/2000/2001/2002/2003/2004

International Turbine And Power, LLC
Bladeless Disk Technologies
931 Rumsey Avenue, Box 550
Cody, Wyoming 82414

All Rights Reserved

frank@germano.com



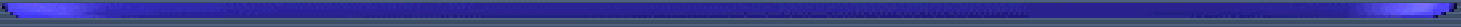

Dr. Nikola Tesla

[[Master Site Index](#)] [[Home](#)] [[Tesla's Technology Today](#)]
[[On-line Tesla Bookstore](#)]

"Were we," remarks B. A. Behrend, distinguished author and engineer, "to seize and to eliminate the results of Mr. Tesla's work, the wheels of industry would cease to turn, our electric cars and trains would stop, our towns would be dark, and our mills would be dead and idle."



Nikola Tesla: A Brief Bio: (1856-1943) - Nikola Tesla was born in Croatia, which at that time, lay within Austro-Hungary. It is interesting to note that he was a Serbian of Valachian descent. Tesla was proud of his Croatian motherland and Serbian descent. When his mother died in 1892, he paid a visit to Croatian capital Zagreb, and gave a lecture about alternating current. On that occasion Tesla said: **"As a son of my homeland, I feel it is my duty to help the city of Zagreb in every respect with my advice and work"** - (**"Smatram svojom duznoscu da kao rodeni sin svoje zemlje pomognem gradu Zagrebu u svakom pogledu savjetom i cinom"**). Nikola Tesla, besides being a great inventor and an outspoken Serbian patriot, had sincerely adored free Serb states, Serbia and Montenegro. He had never hidden his patriotic feelings, on the contrary, he stressed them.

On 1st of June 1892, Tesla arrived in Belgrade due to the call from Belgrade municipality. Several thousand people greeted him at the Belgrade train station. He addressed the gathered crowd, who saluted him: **"There is something within me that might be illusion as it is often case with young delighted people, but if I would be fortunate to achieve some of my ideals, it would be on the behalf of the whole of humanity. If those hopes would become fulfilled, the most exiting thought would be that it is a deed of a Serb. Long live Serbdom!..."** Tesla further said to the students of Belgrade University: **"As you can see and hear, I have remained a Serb overseas where I have done some researches. You should do so and by your knowledge and hard work you should glorify Serbdom over the world."** One of Tesla's proudest moments was when he was granted his United States citizenship; he never lost his love of his homeland, however. His monument, carved by Ivan Mestrovic (who knew Tesla personally), can be seen in Zagreb. Another monument, carved by Croatian sculptor Frano Krsinic, can be seen on "Goat Island", near the former Tesla Hydropower Plant on Niagara Falls, in the middle of the Niagara River, between the United States and Canada borders. It is purposely left *un-illuminated* at night (for the effect, and, to provoke thought of what the world would be like without Tesla's contributions). A part of the Technical Museum in Zagreb is dedicated to Nikola Tesla. Even today, so many years after Tesla's death in 1943, his numerous manuscripts are kept as "top secret" by the US Ministry of Defense (see Margaret Cheney, "Tesla: Man Out of Time", Prentice Hall, 1981)

Nikola Tesla, an American inventor and engineer, whose mastery of electricity came at a time

when electricity was changing American life. Tesla is the unsung creator of the electric age, without whom our radio, auto ignition, telephone, alternating current power generation, alternating current transmission, radio, and television, would all have been impossible. He discovered the rotating magnetic field, the basis of most alternating-current machinery, and held more than 700 patents. His inventions make him one of the foremost pioneers in the distribution of electric energy.

Born into a family of Serbian origin, Tesla's father was an Orthodox priest. He had several sisters and one older brother, Dane, who died when Nikola was five. In his autobiography ("**My Inventions**"), Tesla tells of the early workings of his mind in a description that we can only regard with amazement. He began seeing flashes of light that interfered with his physical vision. When a word was spoken, he would envision the object so clearly that he had trouble distinguishing between the imagined (spoken) object and the real. In later years, he would build a machine in his mind, run it to see where it was flawed, and make whatever repairs and adjustments were needed, *before* he ever began his construction. At night and in solitude, Tesla had an inner world of personal vision where he made journeys to distant places, studies, carried on conversations and met people that seemed as real to him as his outer world. By the time he was a teenager he spoke four languages. At about age 17, he found to his delight that he could create things in his mind, picturing them as the finished product without models, drawings or experiments. He invented such things as a low friction finless waterwheel and a motor driven by June bugs.

He trained to be an engineer, attending the Technical University at Graz, Austria and the University of Prague. Beginning his studies in physics and mathematics at Graz Polytechnic, he then took philosophy at the University of Prague. After finishing the studies at the Polytechnic Institute, doing two years of study in one, working 19 hours a day and sleeping only two, he suffered a complete nervous breakdown. During the malady, he observed many phenomena, both strange and unbelievable. His vision and hearing intensified beyond any normal human capacity. He could sense objects in the dark in the same way as a bat. It was a period in which his sensitivities were so heightened that the flashes of light that he had seen from the time he was a youth now filled the air around him with tongues of living flame. Their intensity, instead of diminishing, *increased* with time, and seemingly attained a maximum when he was about twenty-five years old. His responses were so keenly tuned that a word would become an image that he could feel see and taste. It was during this time that he had one of his most famous ideas; the rotating magnetic field and alternating current induction motor.

Bringing himself back to the world as it is, Tesla began work as an electrical engineer with the Central Telegraph Office in Budapest, Hungary in 1881 and the following year, he went to work in Paris for the Continental Edison Company. In 1883 he constructed, after work hours, his first induction motor.

He sailed to America in 1884, arriving with four cents in his pocket. He found immediate employment with Thomas Edison - who quickly became a rival - Edison being an advocate of the inferior DC power transmission system. For the remainder of his life, Tesla would have, at times, difficulty getting his ideas and inventions funded because most financiers were in Edison's corner. Even later in his life, many of his ideas and inventions could not get funding, and so remained in notebooks, which are still examined to this day, by engineers searching for clues from his brilliant scientific mind. Edison and Tesla parted company within a year due to a false promise made by Edison. Tesla was told (by Edison) that if he could repair all of the faulty and broken down motors and generators in the Edison plant that he would receive \$50,000.00 for his effort. This Tesla did, and in record time, no less. At the

completion of the repair work, Tesla approached Edison for the monies that were promised, at which time Edison replied that he was only "joking" about the money. Tesla did not find it very "funny" and left his employ.

Perhaps the lowest point in his life was in 1884-85 after he left Edison, and without recognition or a mentor, had to take manual labor to survive. He was digging ditches at \$2.00 a day when he met Mr. A. K. Brown of the Western Union Telegraph Company who put up some of his own money and interested a friend in joining him in Tesla's project. Shortly thereafter, Tesla was commissioned with the design of the AC generators installed at Niagara Falls.

Tesla and Edison have often been represented as rivals. They were rivals, to a certain extent, in the battle between the alternating and direct current in which Tesla championed the former. He won; the great power plants at Niagara Falls and elsewhere are founded on the Tesla system. Otherwise the two men were merely opposites. Edison had a genius for practical inventions immediately applicable. Tesla, whose inventions were far ahead of the time, aroused antagonisms which delayed the fruition of his ideas for years. However, great physicists like Kelvin and Crookes spoke of his inventions as marvelous. "**Tesla,**" said Professor A. E. Kennelly, of Harvard University, when the Edison medal was presented to the inventor, "**set wheels going round all over the world. . . . What he showed was a revelation to science and art unto all time.**"

In May 1885, George Westinghouse purchased the patents to his induction motor, his polyphase system of alternating-current dynamos, transformers and motors and made this the basis of the Westinghouse power system which still underlies the modern electrical power industry today. When Westinghouse found that they could not stay in business if they paid him his due of Twelve Million Dollars, Tesla tore up the contract. Tesla did this, quite simply, so people could have the benefit of financially attainable electricity. Tesla made his first million before he was 40, but gave up the royalties on his most profitable invention as a humanitarian gesture.

In April 1887, he established his own laboratory, where he experimented with shadowgraphs similar to those involved in the discovery of x-rays. In 1888 his discovery that a magnetic field could be made to rotate if two coils at right angles are supplied with AC current 90 degrees out of phase made possible the invention of the AC induction motor. The major advantage of this motor being its brushless operation, which many at the time was believed impossible.



By 1890, Tesla was a young, striking and desirable bachelor. Handsome, magnetic and elegant, he was the "catch" of New York society, yet remained unmarried and a misanthrope. He was wealthy, gifted, accomplished and recognized. He wore his clothes well and was quiet and modest. Many a designing matron with a marriageable daughter was eager to capture him for her salon. Social leaders and businessmen considered him a good contact and the intellectuals of his day found him an inspiration. However, Tesla proved to be impervious, an unattainable prize. Except at formal dinners he always dined alone, and never under any circumstances would he dine with a woman at a twosome dinner. At the Waldorf-Astoria and at the famous Delmonico's restaurant, he had picked out particular discrete tables, which were always reserved for him. In spite of all of the adulation that was heaped upon him, Tesla had but one desire – to continue his work. He lived the life of a celibate and a hermit. He enjoyed poetry and the opera and though he was not a drinker, he appreciated a glass of beer and

advocated the limited consumption of liquor as an elixir of life.

In 1915 he was severely disappointed when a report that he and Edison were to *share* the Nobel Prize proved erroneous. Tesla was the recipient of the Edison Medal in 1917, the highest honor that the American Institute of Electrical Engineers could bestow. When others claimed credit for the revolutionary ideas that came from his extraordinary mind, he did not contest them.

Impactical in financial matters, eccentric and compulsive, Tesla had few friends, but those included Mark Twain, John J. O'Neill and Francis Marion Crawford. He never married, and cited on at least one occasion that marriage wasn't good for inventors. He was driven by compulsions and had a progressive germ phobia, washing his hands frequently and avoiding shaking hands and measuring the volume of his food before he ate it. He liked a fresh tablecloth with every meal. Always a fastidious dresser, he wore new gloves weekly and a new tie daily. He maintained the same weight through his lifetime, 142 pounds, and always slept only four hours per night.



The Inventions: Tesla believed that alternating current was vastly superior to (Edison's) direct current, but the problem was the lack of a practical motor. Alternating current is practical because of the fact that it can be altered, or converted, to suit a variety of situations. For example, if the voltage is made quite high, then the current necessary for a specific level of power is very low. This low current then becomes very efficient when sending electrical power over very long wires. (This is the reason why the power lines running across the countryside are at very high voltages.) Tesla also worked with radio-frequency electromagnetic waves, and, despite the claims made by Marconi, actually did invent the idea of Radio as we know it today. (There are numerous patents which bear this out. Even today, many texts still credit Marconi with the invention of radio, despite the Supreme Court decision which overruled the Marconi patent, awarding it to Tesla. Unfortunately, this decision came two years after Tesla's own death.) In working with radio waves, Tesla created the Tesla coil as a means to generate and receive this form of energy. Every time you start your automobile (or virtually any type of vehicle, for that matter) the device that provides "spark" to the spark plug, thus enabling the engine to start, is a unit either wholly or in part, a Tesla Coil.

Tesla postulated the ability to locate objects in the air or in the ground by using radio waves. Today, we call it "RADAR", and when used to peer into the human body, "MRI". Tesla also created radio controlled devices., or "Teli-autonomotons". His work with special gas filled lamps set the stage for the creation of fluorescent lighting, and neon lights.

Tesla patented dozens of devices ranging from speedometers to extremely efficient electrical generators. One unique device was his **bladeless boundary disk turbine**.

Instead of using fan-type blades, Tesla's turbine utilized solid disks of metal, and relied on what is called the "boundary layer effect". His turbine ran on either compressed air or steam or gasoline explosions, and was so efficient that a device held in the hand could produce well over 10 horsepower!



One of the largest turbines that Tesla designed pumped out 10,000 Horse-power, and was about one fifth the size and weight of the engines of its day. Today, this bladeless technology

is being used in a special type of non-clogging pump designed for the oil industry. The turbine is awaiting commercial use, and public acceptance., but developments are rapidly making it again seem attractive. Frank Germano, Guy Letourneau, Tad Johnson and Martin Dorantes, of ***International Turbine And Power***, of Cody Wyoming, USA, is pioneering the design of a special Tesla-Type turbine for the commercial power markets. This turbine can be run on any combustible fuel (propane, methane, gasoline, diesel, hydrogen), steam, or even water under pressure.

It has been said that Tesla is the "***Forgotten Father of Technology.***" It is hard to believe that a man who gave the world so much, received so little for his efforts. History books have been equally unkind.

In many parts of this country, people still refer to the electric utility as the 'Edison Company', even though they use the Tesla-Westinghouse alternating current system, not Edison's direct current. At the Niagara Falls power generating station, a small statue of Tesla is purposely left un-illuminated at night. I have visited this statue, and it is a quite stunning statement to witness the statue in complete darkness, with the surrounding area ablaze with lighting supplied from Tesla's own inventions.

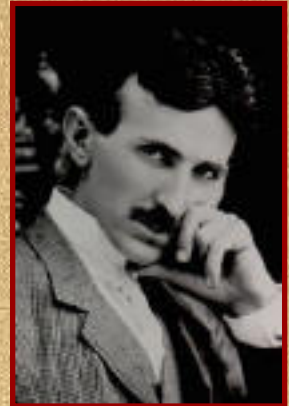

Tesla also had a deep desire to provide wireless electricity across the globe. First, there was the patent infringement issue, which made millionaires of others, particularly the Marconi Company. But Tesla maintained a single-minded focus on developing global wireless communications and energy systems. Working in Colorado Springs in 1899, Tesla developed a transmitter to perfect a method by which transmitted energy could be channeled through natural media.



In Colorado Springs, Colorado, Tesla built a laboratory to develop this. The Colorado Springs lab contained the largest Tesla Coil ever built. Called the ***Magnifying Transmitter***, it was capable of generating some 300,000 watts of power, and could produce a bolt of lightning over 130 feet long. According to local accounts, Tesla actually managed to successfully transmit about 30 to 50 thousand watts of power, without wires, using the Transmitter. There are detailed accounts of these feats, below.

Two years later, 1901, working on Long Island at Wardenclyffe, he set to work on his ultimate goal: construction of a "world telegraphy center" that was to have a lab, a wireless transmitter and production facilities for manufacturing oscillators and vacuum tubes. Constructed on the "model city's" 1,800 acres would be homes, stores and buildings to accommodate 2,500 workers... at least, that was the dream...

By that year's end, however, Marconi had usurped the inventor by transmitting an overseas signal. That left Tesla at the mercy of his financier, J.P. Morgan, who literally pulled the plug on his vision. Morgan, at the time the prime force behind General Electric Co., may have been unnerved by Tesla's claims that the technology could transmit "unlimited power" by wireless means. The word "free" did not translate well to Morgan. Again, the money flow came to a halt.

Some Tesla devotees suspect he may have been a pioneer of the transistor. "Inventors of the modern computer have repeatedly been surprised, when seeking patents, to encounter Tesla's basic ones

already on file," noted Tesla historian Leland Anderson, a former EE and a board member of the Wardenclyffe project. Indeed, two of Tesla's patents from 1903 contain the basic principles of the logical "AND" circuit element. Tesla went on to experiment with actual wireless transmission of electrical power.

Despite his accomplishments, by 1915, at age 60, Tesla was living on credit and drifting from one cheap hotel another, a victim of his own poor business decisions, underdeveloped ideas and inability to create another innovation as profound as the AC paradigm. In 1931, at the age of 75, Tesla received birthday greetings from Lee de Forest and Albert Einstein. In his later years he spent most of his time at the New York Public Library or feeding pigeons that he called- "my sincere friends".

By 1943, he had begun suffering heart trouble and fainting spells along with some mental confusion. On January 1st, 1943 he complained of chest pains during an experiment and returned to the hotel room where he lived. The last person to see him alive was a hotel maid on January 5th, 1943. It is assumed that he died January 7th, 1943 in New York City and his body was discovered on the following day. Over 2,000 people attended his funeral in Manhattan. So, at age 86, the great inventor died alone, nearly penniless and all but forgotten. Years earlier, however, Tesla had appeared to predict the posthumous recognition that today's scientific community would afford him when he wrote: **"Let the future tell the truth, and evaluate each one according to his work and accomplishments."** And what accomplishments they were, Dr. Tesla. The world would be a very dark place, without you. For more startling insight into Dr. Tesla's amazing accomplishments, see the companion article: [Nikola Tesla And His Work With Alternating Currents](#) .

"The present is theirs ; the future, for which I really work , is mine." Nikola Tesla

"Quick-click" Index to this Page. Use these links to jump to each section and return. Or, if you prefer, just use the "next" and "back" links...below.

CONTENTS

[\[Tesla's "Magnifying Transmitter"\] The Wireless Transmission of Electrical Energy\]](#)

[\[Telsa Coils and the "World System of Power"\]](#)[\["The World System of Power"\]](#)

[\[Transmission of Electrical Energy without Wires\]](#)[\[Tesla's Earthquake Machine\]](#) [Radiant Energy System\]](#)

[\[Famous Tesla Quotes\]](#)

An Amazon.com banner advertisement. On the left, it says "shop now AND SAVE Save big on thousands of products!". In the center, there is a list of product categories: Computers, Books, Music, and DVDs, with a mouse cursor pointing to the list. On the right, it says "amazon.com and you're done." and "Click Here".

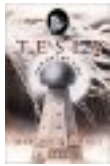

Tesla

Margaret Cheney
New \$10.20!
Used \$5.75!



My Inventions

Ben Johnston
New \$9.95!



In Search of Nikola

Tesla

F. David Peat
New \$10.47!
Used \$8.36!



The Fantastic
Inventions of Nikola

T...

Nikola Tesla
New \$11.53!
Used \$10.20!



Tesla

George Trinkaus
New \$7.75!



Inventions,
Researches and
Writings ...

Thomas C. Martin
New \$25.80!
Used \$18.99!



Wizard

Marc J. Seifer
New \$13.57!
Used \$11.97!



Nikola Tesla's
Earthquake Machine

Dale Pond
New \$14.41!
Used \$10.39!

My Inventions

Nikola Tesla
New \$12.95!
Used \$9.95!

(Prices May Change)

[Privacy Information](#)

Books

Music

Enter keywords...

amazon.com

NEXT

*"If ever we can ascertain at what period the earth's charge,
when disturbed, oscillates -*

*we shall know a fact, possibly of the greatest importance to the welfare of the human race." ; Nikola
Tesla, 1893*

Two great articles in which Tesla predicts the future:

[[A Machine To End War](#)] and [[The Wonder World To Be Created By Electricity](#)]

I hope you have enjoyed the information presented on this page. I also hope that you will take something away with you - knowledge. Nikola Tesla was perhaps the most important figure in the twentieth century. Think of the world today, and what it would be like without the contributions Tesla gave us. Thank You for visiting the site,

Frank Dominic Germano
President
International Turbine And Power

frank@germano.com

[Back To INDEX](#)

Subscribe to TheTeslaTurbineList

Powered by groups.yahoo.com

NIKOLA TESLA:

[\[Home\]](#)[\[Tesla Technology, Today\]](#)[\[Nikola Tesla\]](#)
[\[Tesla Tunguska; Free Energy\]](#)
[\[The Tesla Bladeless Boundary Disk Turbine\]](#)
[\[Tesla's "Black Box"\]](#)[\[Greatest Hack of All Time?\]](#)
[\[the Lost Tesla Inventions\]](#)[\[A Machine To End War\]](#)
[\[the Wonderworld to be Created by Electricity\]](#)

[[the Nikola Telsa & Viktor Schauburger -plus- Bookstore](#)]

VIKTOR SCHAUBERGER:

[\[Water Power - Vortex Theories-\]](#)[\[Water Power II\]](#)

[\[Viktor Schauburger -1-\]](#)[\[Viktor Schauburger -2-\]](#)[\[Viktor Schauburger -3-\]](#)[\[Viktor Schauburger -4-\]](#)

[\[Christian Links\]](#)





FRANK.GERMANO.COM

ENTER THE SITE

Welcome to "Frank.Germano.com". This website was created to provide some "fresh air for a dying planet." Now, more than ever, we need to take a very hard look at how we are treating not only the planet Earth's resources, but also ourselves and our environment. I started planning this website by selecting two figures from our recent historical past, each of whom offered mankind, in general, the ability to expand beyond conventional limitations imposed by our deliberate, uncaring and wasteful treatment of our natural resources. These two men - Nikola Tesla and Viktor Schauburger - no matter how great their contributions, nor how incredible their inventions, theories and ideas, have been (sadly) nearly forgotten by modern history. They each have been all but excluded from the classrooms of the

school and college systems. Hopefully, in some small way, my website will encourage you to study the ideas presented herein, further.

This website also contains information and documentation on the Tesla Bladeless Boundary Disk Turbine and Tesla Bladeless Boundary Disk Pump. These amazing engines and pumps were originally invented by Dr. Nikola Tesla in the early 1900's. You will explore volumes of forgotten information on the life, inventions and dreams of one of the most important figures in modern times. Numerous articles, documents, and period newspaper publications, pertaining to Tesla's dreams and predictions of the future (from a late 19th to early 20th century standpoint, mind you), as well as many items found nowhere else on the web, are presented.

I have included several pages dealing with the theories of the Water Wizard - Viktor Schauburger. I have done my best at interpreting and extrapolating the information contained in his patents, and presenting it in a format which, hopefully, will be understood by most everyone. It is my belief, that by combining Schauburger's theories on the "living energies" contained in water with the Tesla Turbine, a radical approach to how we obtain and distribute electrical energy will result. Non-polluting, environmentally sound, readily obtainable, virtually "free" energy, that can be distributed economically to everyone on the planet. At the very least, it will be a revolutionary concept. I have gathered together most of Viktor Schauburger's wonderful inventions, and a very large database of information about his intuitive, far-reaching environmental theories. I think you will be quite taken back at the scope of his work. Take your time and enjoy each section...There are also TWO active Yahoo Lists that you can join to learn more about our technology - the Tesla Turbine List, and the Viktor Schauburger List. Thanks for visiting. FDG.

Finally, in the same thoroughness that I apply to the scientific research on Tesla and Schauburger, I offer a section on Christian study. If you feel like confronting the facts presented in the Word of GOD - the Bible - take a look through the sections presented. I have pretty much covered many of the controversial, and too often miss-understood, subjects. Compliments of one the most fantastic teachers of God's Word; **Pastor Arnold Murray**, the Shepherd's Chapel, Gravette, Arkansas.

ENTER THE SITE

frank@germano.com



7556606

www.UltimateCounter.com

This website was produced, designed and is controlled by: Frank Germano

TESLA TECHNOLOGY, TODAY

7552992
www.UltimateCounter.com

"InVAID Systems"

Tesla & Schauberger Technologies
Bladeless Disk, Vortex & Implosion Technologies

"a complete systems approach to power; clean, environmentally sound energy production and water transport, storage and revitalization"

Before we can begin, we need a brief description of our company history: "International Turbine And Power, LLC" (our former corporate entity) was founded by myself and a group of highly energetic engineers and scientists in 1998. We had only one goal; design a working Tesla Turbine and Tesla Pump. This goal became reality. During the 2000, 2001 and 2002 years, five functional **prototype turbines** were designed, built and tested, with each yielding remarkable performance results. Individual investors and investment companies provided the necessary funding of several million dollars for this research and development stage.

This year, 2004, Martin Dorantes, Guy Letourneau, Tad Johnson and I (Frank Germano - the four original founding members of ITP, LLC), dissolved the ITP entity, and have begun operations, independently. The newly formed company, "InVAID Systems", with Frank Germano at the helm, has continued production of these revolutionary power and pumping systems. Our turbines and pumps are based on the pioneering research originally begun by **Nikola Tesla**, and of which he patented in 1911. Our prototype turbines have confirmed Tesla's claims, and, in our opinion (and third-party testing and validations), these turbines have become the "most simple rotary engines" yet designed. We have improved on Tesla's original design by further incorporating the vortex and implosion designs pioneered by yet another of history's forgotten figures, namely - **Viktor Schauberger**. Should conditions again become feasible for investors to take note of this technology, it is quite possible the original team will reunite, once again. Time will tell.

To paraphrase Nikola Tesla - **"Suppose someone should discover a new mechanical principle... something as fundamental as James Watt's discovery of the expansive power of steam, by the use of which it became possible to build a motor that would give ten horse power for every pound of the engine's weight? A motor so simple that a novice in mechanics could construct it and so elemental that it could not possibly get out of repair. Then suppose that this motor could be run forward or backward at will, that it could be used as either an engine or a pump, that it cost almost nothing to build as compared with any other known form of engine, that it utilized a larger percentage of the available power than any existing machine, and, finally, that it**

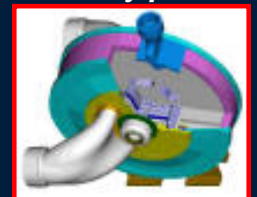

would operate with gas, steam, compressed air or water, any one of them, as its driving power..."

Frank Germano is now concentrating his work on distinct products and product lines:

- 1.) **The Bladeless Disk Turbine* (BDT) Power System**; complete, self-contained power generation systems. Fuel supply is from either Hydrogen, methane, diesel, gasoline, kerosene, propane, or steam (from steam supply generated by your choice of fuels).
- 2.) **The Bladeless Disk Pump (BDP)**; highly efficient pumping systems designed for various applications where conventional impellor or bladed pumps are not applicable.
- 3.) **Airships and Submarine Technologies**, with the Tesla Bladeless Disk technology system providing the thrust, and Schauberger's vortex theories used in the design criteria.

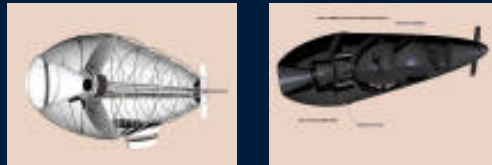

- 4.) **Complete water transport and "revitalizing" technologies**, incorporating the inventions of Viktor Schauberger, with power systems and pump designs from Nikola Tesla.
- 5.) **Tesla-type BDP SuperChargers** for motorcycles (the Harley-Davidson), and vehicle specific cars (the Subaru XT6, Honda Civic, Acura Integra, Mazda RX7 to name just a few). This has now become my "pet" project!

*In the BDT (Bladeless Disk Turbine), we have designed a power system that will run either a 20, 50, 100 or 500 KW generator. Much larger units can easily be designed, and supply virtually any required power levels. This unit is designed to be portable, allowing you to take your "power" with you (great for contractors or second/vacation homeowners!). They are self-contained, short of your fuel supply. They will run on Propane, Natural Gas, Hydrogen (where available), Diesel, or standard Pump Gasoline. After the recent events (AUG 14-15, 2003) and the 50,000,000 people affected by a large-scale power blackout, this system becomes very attractive. The alternative to not having your own power system, independent of the electrical grid, is not. With individuals possessing their own power supply, no electrical interruption of service can ever incur. As long as you have an adequate fuel supply to your home or small business (we advocate propane gas or hydrogen production gas), you will always have electricity. Pretty simple in concept.

Germano, of "InVAID Systems", is currently designing the next generation of powerful, efficient engines and pumping systems.

We call this revolutionary engine, a "thermodynamic transformer," or "BDT" as this is a more proper name for the device. Our engine is based on the pioneering work of Nikola Tesla. His engine - the Tesla, Bladeless Boundary Disk Turbine - was originally developed in the early 1900's. These engines, powered by steam, or any combustible fuel, such as methane, natural gas, propane, gasoline, diesel, or hydrogen, or even flowing water from rivers or from an ocean's tides, offer an incredible advantage over "conventional" engines. They are fairly inexpensive, extremely efficient, require virtually no maintenance, and will run in environments where other engines, would, quite simply - fail.

This engine offers an incredible advancement over "conventional" units (Turbines, Diesel, Internal Combustion, etc.), in both efficiency, simplicity *and* economy. The Tesla Turbine and Tesla Pump function on the principles of adhesion and viscosity, or "boundary layer" drag. The Tesla Turbine itself, is a very simple device, consisting of basically, a number of very thin disks, mounted on a shaft, with their centers cut out in sections...this assembly is then enclosed in an air tight case. Pure simplicity.

Such a machine is a "thermodynamic transformer" of an activity surpassing, by far, that of any other prime mover, it being demonstrated in practice that each single disk (i.e. this is why it is called "bladeless") of the rotor is capable of performing as much work as a whole bucket-wheel of a conventional turbine. Besides, a number of other advantages, equally important, make it especially adapted for operation as an internal combustion motor. Please note: the turbine is nothing more than an efficient energy transformer - it is NOT an engine, in and of itself - it needs a form of motive impulse (power), i.e. steam or pressure and velocity from a combustion source - to operate.

With our **Thermodynamic Transformer (BDT TT)** engine/turbine design, our Tesla/Schauberger type Pumping system - the Bladeless Disk Pump, the "**Centrifugal Molecular Implosion Turbine® (CMIT)**", "**Fresh-Cool® Air conditioning and Heat-Pump Systems**, and, our revolutionary "**InVAID® (Vortex Accelerated Implosion Drive)**", **Water Powered Systems**, we are in a position to offer **GLOBAL** energy solutions. All of our systems use environmentally sensible and sustainable technology. Our mission statement -

"Bringing fresh air and fresh ideas to a dying planet."

Frank Germano is actively seeking investors and interested partners to join with us thus allowing the introduction of this amazing technology to the world. We will gladly provide more information to "*qualified*" investors. Contact information is listed, below. Follow the link, below, for a listing of our full capabilities.

Click below for applications and systems offered

[**Bladeless Disk, Implosion & Vortex Technologies: Global Energy Solutions**](#)

Contact Frank Germano by email

Applications and Systems

"Just what is your new invention?" I asked. "I have accomplished what mechanical engineers have been dreaming about ever since the invention of steam power," replied Dr. Tesla. "That is the perfect rotary engine..." Nikola Tesla, 1911

As anyone who reads today's headlines, or watches a Television newscast, one does not need to look far to realize that our Nation is in an immediate energy crisis. This is not only happening in the United States, but appears World-Wide. We have relied on outdated forms of "prime movers" and inefficient forms of power generation and supply for nearly a century. The technology, in the form of the original Tesla Bladeless Boundary Disk Turbine, was applicable in Tesla's time...it is not only beneficial, but may be critical to implement this technology in OUR time!

Everyone hears the buzzwords - "decentralized power stations"...I do not have the space here to amplify on the exact definition, however, it is quite probably the most cost effective solution to our current electrical energy situation. Small, efficient "powerhouses-in-a-hat" (the term coined by the media of Tesla's day for the Tesla Turbine) will be employed in towns, communities, groups of houses, and around large cities, augmenting the current Utilities power supply. We are in the enviable position of being quite able to assist end-consumers in this energy crisis.

So just what the heck is this thing?! The BDT TT engine has a weight to output horse power ratio of up to an unbelievable 10 HP per pound. It has the ability to run on almost any fuel. It is incredibly compact and lightweight. Pollution output from the exhaust of even the propane version is FAR below that of even today's best standard engines. The system also lends itself in use as an "air to air" refrigeration system without the need for harmful Freon gasses. The engine, by its very nature of operation is perfectly suited to "Turbo/Electric" applications. The BDT-TT engine is unequalled in it's simplicity and output, far exceeding any other conventional engine to date.

Almost a quarter of the air pollution today comes from the coal being burned to generate electricity. Fuel consumption, resulting in air pollution and acid rain, could be significantly reduced simply by replacing the conventional blade steam turbines currently used by utilities with the Bladeless Tesla Steam Turbine (BDT). This also would have the added bonus of drastically reducing maintenance. But the **real solution** lies in using low temperature wet steam occurring naturally from the ground in the form of **geothermal energy**. This energy would destroy a conventional bladed steam turbine, unless expensive steam drying is employed. **However, the Bladeless Tesla Steam Turbine (BDT) requires no drying and can be connected directly to the geothermal source!!!**

It has been estimated that the geothermal potential in just Southern California alone, could power the entire North American Continent with NO POLLUTION! Dare to take us up on this (offer) statement, and the United States will be provided with an unlimited, free energy supply - directly from the steam (heat source) of the Earth, itself. Add to this the large geothermal potential of Wyoming (think of the geysers in "Yellowstone National Park" - that's geothermal energy), Oregon, Washington, Idaho and Montana, and you will begin to get the picture of the enormous geothermal potential available in the Northwestern states alone. Large oil companies have comprehended the potential of geothermal energy and have purchased many of these large tracks of prime geothermal land. Due to the revolutionary concepts embodied in this engine, we can easily end the so called energy crisis and dramatically reduce pollution. Even the vested energy interests are beginning to understand that now is the time for change, realizing their future health and wealth is directly linked to that of the environment.

Environmentally sensible usage of available resources - "some fresh air for a dying planet"; Germano's credo.

There are a number of individuals and young companies now interested in building and designing Tesla-type engines. Many have their own approaches to design. One thing to keep in mind is this: follow Tesla's designs first, and after achieving a working, efficient engine design, then begin modifying. Far too many builders have claimed that the Tesla Turbine is somehow "faulty," or flawed... however, upon examination, it is clear that it was the builders mistakes and/or changes that caused the failure of being unable to attain Tesla's amazing results. I began this venture with the premise that the Tesla design was absolutely correct, and that by following the patent information faithfully, we would end up with a working turbine. That has proved more than true. Industry will almost definitely be forced to look further at our engine, as it will soon present itself to be a "best available technology." When that day comes, as it certainly will, **Germano** will be capable of implementing the engine into commercial use.

We advocate a SYSTEMS APPROACH to our products. For a standard, personal or business solution, we recommend a decentralized power grid system for electrical supply and distribution. From the pump in your private well, to the delivery of the water itself (in bamboo, spiral vortex inducing plumbing), to the storage of the water (in clay and terracotta storage vessels, shaped in the form of an elongated egg shape to further induce the vortex activation of the water), to vortex generating units throughout the home, to your own self-contained electrical power supply; electricity supplied to your home directly from a multi-fuel Bladeless Disk Turbine & Generator System...we can provide an entire package for energy supply, to water supply, to water revitalization, which yields many benefits to the end consumer. This same system on a larger scale can power industry, large or small towns or cities or communities, and classic commercial applications.

PRODUCT AVAILABILITY

The BDT TT engine, pump, "InVaid", "Fresh-Cool", and "CMIT" systems are in prototype stages. We have fully functional units which we will gladly demonstrate at our facilities in Austin, Texas. For a confidential demonstration of our technology, contact us at the address below.

Information On Prototypes and Special Requests: For a response, either on the dates of availability, the engines themselves, investment opportunities, or for companies and individuals interested in purchasing our engine, pump, or system packages in a PROTOTYPE stage immediately, please contact us by email, directly. We will respond to each email, based on priority, as quickly as possible. We can also evaluate any and all requests for installation of our technology in your present structures.

Standard Engineering Fee for consultation: Mr. Frank Germano, Mr. Martin Dorantes, and Mr. Guy Letourneau, P.E. charge a standard engineering fee of - \$165.00 per hour for answering requests and provides detailed reports on our technology to **qualified** individuals and investors. This fee is refundable if purchase of one of our products is made within 90 days of the request and the delivery of the requested unit. Contact one of us through email links below for a full description of the services offered. We can easily look at all commercial applications and review your presently installed systems and offer suggestions and/or improvements to the existing system. By incorporating our technology, a quite substantial improvement in efficiency as well as energy savings will almost definitely result.

Investor Information: Our main focus is in the Research and Development field. We welcome the opportunity to design and build fully operational Tesla-type turbines and pumps for other individual corporations and businesses. Investors are encouraged to contact us, directly. We also can work in a joint-venture capacity, with certain contracts. When the turbine, pump, "Fresh-Cool", "Centrifugal Molecular Turbine" and "InVAID" systems become commercially available, it is our firm belief that we can attain a massive market share and offer an extremely high return on invested dollars, in a very short timeframe. Note: the **BDT TT**, **CMIT** and **InVaid** systems are patentable. Guy Letourneau, P.E. has already garnered patents on several key areas of the BDT construction. **There is no other company that we are aware of that can offer this amazing technology.** Contact us directly for a full disclosure.

***As stated in many different locations on this site and webpage, all of our units are in the prototype stage! The cost for each of these units and systems is, therefore, based on applying our standard engineering fee (\$165.00 per hour for design services) plus the individual cost of manufacture, shipping and installation. ** For qualified individuals and investors interested in making a commercial release feasible and profitable, please see below for further information.**

Components of the CMIT bladeless engine, below:

1.) Internal Components 2.) Internal Components 3.) Operational Engine 4.) Thumbnail view internal components (click for larger view) 5.) (click for larger view). All images courtesy of "International Turbine And Power, LLC." Used by permission. Copyright© Protection applies. What you are looking at below is one of our BDT (bladeless disk turbines) both operational, and with its internal component structure. Pretty simple. Our corporate entity, formerly "International Turbine And Power, LLC," has done what most have felt was impossible - we have proved the validity of Tesla's claims about the bladeless disk, boundary layer turbine and pump. They are the most efficient, perfect rotary engines and pumps available today. Note:**You may not copy nor distribute images without permission from International Turbine And Power, LLC.** For the history of our bladeless disk turbine's development, use this link - [Operational BDT units.](#)



1.



2.



3.

4.



Enlarge picture #4 for an exploded view of the internal components of the "Charlie" series Tesla turbine (BDT).

Bladeless Disk, Implosion & Vortex Technologies - documents our full capabilities.

International Turbine And Power, LLC - the *official* corporate website. ITP has ceased operations, effective August, 2003. Germano, Letourneau, Johnson and Dorantes have begun working independently, although on some projects, work can possibly be done together. All units will be based on the Bladeless Disk designs from Nikola Tesla, and incorporating the implosion/vortex designs of Viktor Schauberger. This new company will form quite quickly, with a start date of operation expected in early 2004. This link will remain active long enough for that change to occur.

International Turbine And Power, LLC

Frank Dominic Germano

Co-founder & member

Bladeless Disk Technologies

931 Rumsey Avenue, Box 550

Cody, Wyoming 82414

the TESLA TURBINE: Historical Perspective

"The Electrical Experimenter- The Tesla Gas Turbine" ...July, 1920

"Dr. Nikola Tesla, whom the readers of this publication know very well and whose amazing work in the various scientific fields is also universally recognized, again comes in the limelight with a remarkable explosive gasoline turbine perfected by him recently which he describes in detail in a patent just granted. This remarkable turbine does away with all the troubles and complexity to the former attempted types. Stated briefly, the invention consists in the production of a peculiar shape conduit, thru which the gases are admitted into the turbine, and which has the singular property of permitting their passage in that direction only; in other words, uni-directionally. This device when used in conjunction with the bladeless turbine produces an engine which may be explosively operated by gasoline, alcohol, or other fuels and is absolutely devoid of all valves. It is the simplest internal combustion motor conceivable. Owing to the tremendous output of the turbine, one single disk being practically equivalent in performance to a whole bucket wheel, a very small machine of this kind is capable of developing an astonishing amount of power...

The upper part of the turbine casing has bolted to it a separate casting, the central cavity of which forms the combustion chamber. To prevent injury thru excessive heating, a water jacket may be used, or else water injection, or air cooling, this all the more readily as very high temperatures are practicable.

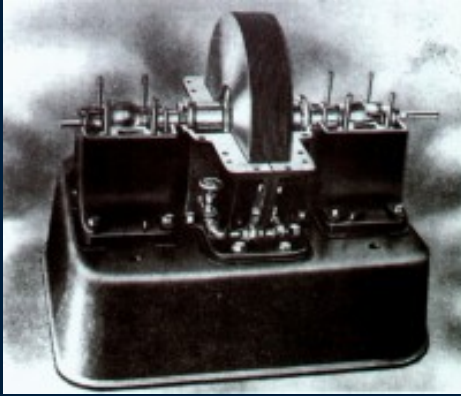

The top of the casting is closed by a plate with a spark-plug inserted and in it's sides are screwed two of the valvular conduits communicating with the central chamber. One of these is , normally, open to the atmosphere while the other connects to the fuel source.

The bottom of the chamber terminates in a suitable nozzle which consists of separate member of heat-resisting material. To regulate the influx of the explosive constituents and secure the proper mixture the air and gas conduits are equipped with regulating valves. The exhaust openings are in communication with a

ventilator..."

Quotes from Nikola Tesla, circa 1911...

"It is a radical departure in the sense that its success would mean the abandonment of the antiquated types of prime movers on which billions of dollars have been spent. Under such circumstances the progress must needs be slow and perhaps the greatest impediment is encountered in the prejudicial opinions created in the minds of experts by organized opposition."

"I have developed 110 horsepower with disks nine and three quarter inches in diameter and making a thickness of about two inches. Under proper conditions the performance might have been as much as 1,000 horsepower. In fact there is almost no limit to the mechanical performance of such a machine. This engine will work with gas, as in the usual type of explosion engine used in automobiles and airplanes, even better than it did with steam. Tests which I have conducted have shown that the rotary effort with gas is greater than with steam."

"It is the lightest prime mover ever produced and can be operated without trouble at red heat, thereby obtaining a very high economy in the transformation of energy."

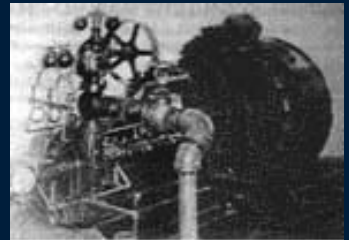

The 110 HP Tesla Engine



5,000 H.P. Tesla Steam Turbine

amazon.com Save \$20 on your first purchase at Amazon.com
 earn Free Rewards Learn More
 Privacy Information

[Click here for the Nikola Tesla and Viktor Schauberger Bookstore, from "AMAZON.COM"](#)

[SITE INDEX](#)

NIKOLA TESLA:

- [\[Home\]](#) [\[Tesla Technology, Today\]](#) [\[Nikola Tesla\]](#)
- [\[Tesla Tunguska, Free Energy\]](#)
- [\[The Tesla Bladeless Boundary Disk Turbine\]](#)
- [\[Tesla's "Black Box"\]](#) [\[Greatest Hack of All Time?\]](#)
- [\[the Lost Tesla Inventions\]](#) [\[A Machine To End War\]](#)
- [\[the Wonder world to be Created by Electricity\]](#)
- [\[the Telsa & Schauberger Bookstore\]](#)

VIKTOR SCHAUBERGER:

- [\[Water Power - Vortex Theories-\]](#) [\[Water Power - II\]](#)
- [\[Viktor Schauberger -1-\]](#) [\[Viktor Schauberger -2-\]](#) [\[Viktor Schauberger -3-\]](#) [\[Viktor Schauberger -4-\]](#)
- [\[Implosion Technology Report\]](#)

[\[Christian Links\]](#)



frank@germano.com



ONE: The Nikola Tesla Bookstore -

Computers
Books
Music
DVDs

amazon.com
and you're done.SM

Click Here



[Tesla](#)
Margaret Cheney
New \$10.20!
Used \$5.75!



[My Inventions](#)
Ben Johnston
New \$9.95!



[In Search of Nikola Tesla](#)
F. David Peat
New \$10.47!
Used \$8.36!



[The Fantastic Inventions of Nikola Tesla](#)
T...
Nikola Tesla
New \$11.53!
Used \$10.20!



[Tesla](#)
George Trinkaus
New \$7.75!



[Inventions, Researches and Writings ...](#)
Thomas C. Martin
New \$25.80!
Used \$18.99!



[Wizard](#)
Marc J. Seifer
New \$13.57!
Used \$11.97!



[Nikola Tesla's Earthquake Machine](#)
Dale Pond
New \$14.41!
Used \$10.39!

[My Inventions](#)
Nikola Tesla
New \$12.95!
Used \$9.95!

(Prices May Change)

[Privacy Information](#)

Save \$20 on your first purchase at Amazon.com

earn **Free Rewards**

[Learn More](#)

[Privacy Information](#)

[View all 113 available Nikola Tesla books at my Amazon.com store. Click Here!](#)

[My personal favorites - Nikola Tesla Books](#)

Wizard : The Life and Times of Nikola Tesla : Biography of a Genius Marc J.

Seifer / Hardcover / Published 1996 WIZARD: THE LIFE & TIMES OF NIKOLA TESLA has taken me 20 years to write. My key reasons for writing the book were to try and answer many of the questions left unanswered by the other authors, such as why Tesla's name dropped into obscurity, whether or not he really received signals from Mars, how his magnifying transmitter really worked, what exactly happened to cause his failure with JP Morgan, what happened to his secret particle beam weaponry papers, and would his particle beam weapon have really worked. The book is set up completely chronologically, and begins with a quote for each chapter. It also differs

from the other biographies in a number of other ways mainly because I had access to hundreds of documents which had never been published before, many received through the Freedom of Information Act. For instance, for the first time ever, WIZARD explains why Tesla stopped working for Edison, why Steinmetz dropped Tesla's name from his textbooks on AC power, why Michael Pupin never mentioned Tesla's name in his physics courses at Columbia University, how Tesla pre-dated Rutherford, Bohr and Einstein in theories on the structure of the atom and on what came to be called Quantum physics, how Marconi pirated Tesla's apparatus, why Tesla had a falling out with his editor TC Martin, John Jacob Astor, JP Morgan and John Hayes Hammond Jr, what Tesla's link to the Navy was, how Franklin Roosevelt used the Tesla patents to block payments on wireless apparatus to Marconi, yet at the same time cut Tesla out of the Marconi/Sarnoff/Westinghouse deal to create RCA, how Tesla interacted with Telefunken, the German wireless concern during WWI and the US War Department during WWII to help them design a particle beam weapon, and how and why Tesla's name has been picked up by cult circles. This new trade paperback edition has a new illustration of Tesla's flying wing VTOL which was a forerunner of Lockheed Martin's X-33 which will replace the shuttle, and also a new section on the June 1908 explosion at Tunguska Siberia. The book contains over 1400 endnotes including references to 250 documents never published before, a full bibliography and index, and 16 pages of photos. Best wishes, Marc J. Seifer, Ph.D. Author .

The Fantastic Inventions of Nikola Tesla (The Lost Science Series) ~ Usually

ships in 24 hours Nikola Tesla, David Hatcher Childress (Editor) / Paperback / Published 1993 Our Price: \$13.56 ~ You Save: \$3.39 (20%)

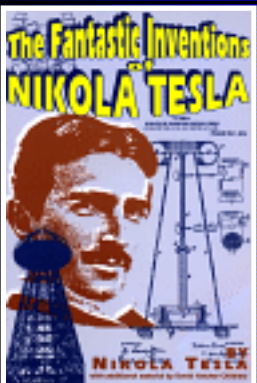

Nikola Tesla is a man misplaced by time. He belongs in the future. He wanted to bring free power to the World using superior technology, opposed to the current system we use, that HE designed. J. P. Morgan, Tesla's financier, pulled the plug on the project due to money considerations. The book presents several of Tesla's patents, and details a few of his major projects.

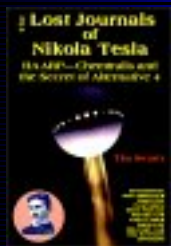

The Lost Journals of Nikola Tesla : Haarp - Chemtrails and Secret of Alternative

4, by Tim Swartz. Our Price: \$14.95 Availability: Usually ships within 24 hours. Paperback - (October 15, 2000) 160 pages

"May be the most important book yet on the mysterious wizard Nikola Tesla. Secret lost journals have been unearthed..." Book Description: SENSATIONAL DATA OBTAINED

FROM THE INVENTOR'S MOST PRIVATE PAPERS AND KEPT UNDER WRAPS BY THE MILITARY AND BIG BUSINESS CONCERNS This book is for all those who feel that the military industrial complex is attempting to control our lives, our financial affairs and our belief structure. The evidence is overwhelming! Discredited in his time, Nikola Tesla was made out by business competitors and the government to be nothing more than a kook. Nonetheless, the same conspirators later duplicated -- and possibly even stole -- many of Tesla's most fabulous inventions which could soon change the course of history as well as our lives! EXPOSED. . . * Reverse Gravity. * Free Energy. * Contact With Hidden Dimensions. * Mysterious Signals From Space. * Earth Changes. * Freak Weather. * Electric Death Rays. * UFOS. * Particle Beam Weapons. Put into Top-Secret use by agents of the New World Order and the global political monetary elite, many of Tesla most powerful and potentially dangerous scientific discoveries are being turned against ordinary citizens in programs of behavior and physical modification. This is being done to influence our critical thinking and belief patterns to make us more susceptible to the mental commands of the Secret Government. One of the most recognizable of these sinister programs is the seeding of clouds with mind and body altering chemicals. These mysterious chemtrails (as they are called) have been widely seen and photographed as they criss-cross the sky in bewildering patterns. Tesla fought all his life against the "Evil Empire" which is emerging as a fire breathing dragon as we get pushed head first into the new millennium.

In Search of Nikola Tesla ~ Ships in 2-3 days David Peat / Paperback /

Published 1989 Our Price: \$21.00

Well balanced view of Tesla's wireless power., January 5, 1999:

While Peat does an excellent job at reporting of broadcast power from a critical standpoint, some very speculative statements are made about Tesla himself (e.g. He completely suppressed his own emotions in an attempt to use reasoning only) I had some objections to the reliability of part of the information presented. Peat offers allot

of good information and the book is worth reading if your interested in Tesla and his works, particularly broadcast power.

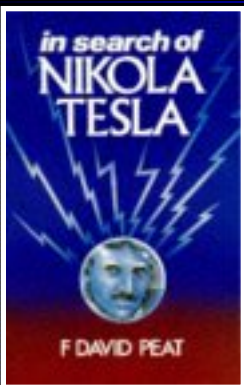



My Inventions : The Autobiography of Nikola Tesla ~ Usually ships in 24

hours Ben Johnston Editor) / Paperback / Published 1982 Our Price: \$7.95
 Book Description : Tesla's autobiography, originally printed as a series of six magazine articles in The Electrical Experimenter magazine. Complete with all original plus 6 additional illustrations. From the Publisher: My Inventions has been the primary source for all Tesla biographers. Editor Ben Johnston has a 16 page introduction that traces Tesla's career through a maze of sensationalism and controversy. Back cover : The reclusive, brilliant engineer who: Invented the Niagara power system that made Edison's obsolete Sold Westinghouse 40 patents that broke a General Electric monopoly Discovered the radio methods that Marconi converted into a fortune Built a radio-guided torpedo before Ford ended the horse-and-buggy era Tried, with J.P. Morgan's backing, to change the earth's electric charge! Joined giants Ampere, Watt, and Volta in history's most select circle when the world scientists named a new unit of magnetism and Tesla.

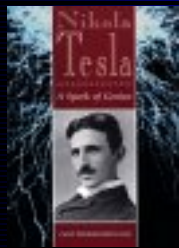

Nikola Tesla : A Spark of Genius (Lerner Biographies) ~ Ships in 2-3 days Carol

Dommermuth-Costa / Library Binding / Published 1994 Our Price: \$25.26...
 Editorial Reviews: From Booklist Gr. 5-9. The author traces the life and career of an eccentric but brilliant inventor and pioneer in the field of electricity, from his birth in Croatia through his technical training in Europe and his subsequent successes and frustrations in America. A less familiar name in this country than fellow inventor and rival, Thomas Edison, Tesla

discovered and perfected the principle of alternating current (AC), as opposed to Edison's direct current (DC). The author credits Tesla, rather than Marconi, with the invention of the radio and discusses Tesla's pioneer work in the field of robotics. The writing is sometimes disjointed, and much of the material is overly anecdotal. The fact that the author is a member of the Tesla Memorial Society and a definite "fan" comes through loud and clear, but this is a reasonable choice for libraries searching for a wider range of biographies for younger readers, especially in the area of science, and for developing collections that offer a multiethnic look at human achievement. There are many black-and-white photos, a few technical drawings with basic explanations as to how various inventions worked, and a short bibliography of books and articles. Jeanne Triner.

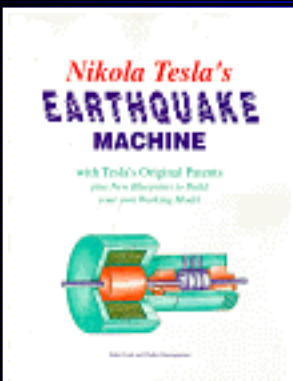

Nikola Tesla's Earthquake Machine ~ Usually ships in 24 hours Dale Pond,

et al / Paperback / Published 1995 Our Price: \$16.95
 Reviews : Book Description In 1935, Nikola Tesla revealed that an earthquake in the region of his New York laboratory in 1898 was the result of a machine he had been experimenting with. This book presents his technology based on sonic vibrations. Now for the first time the secrets of the Tesla Oscillator are available to both the layman and advanced researcher.

From the Back Cover Nikola Tesla's Earthquake Machine... Tesla's Original Patents plus New Blueprints to Build your own Working Model... Now for the first time, the secrets of this machine are available to you... This new manual presents a new technology. It is based on sonic vibrations which can be produced by a comparatively simple apparatus - The Tesla Oscillator. In the oscillators or transmitters described in this book, a resonance effect can be observed. Resonance

appears to be an ever-expanding, magnifying effect with these transmitters. Very little input energy is required to set the device in motion and build that motion to tremendous levels of usable energy. The principle employed is called "Amplitude Modulated Additive Synthesis" by music industry engineers. We have included a full chapter on vibration physics to explain what happens. Excerpt from the New York World - Telegram, July 11, 1935 - Nikola Tesla revealed that an earthquake which drew police and ambulances to the region of his laboratory at 48 E. Houston St., New York, in 1898, was the result of a little machine he was experimenting with at the time which "you could put in your overcoat pocket." The bewildered newspapermen pounced upon this as at least one thing they could understand and "the father of modern electricity" told what had happened as follows: "I was experimenting with vibrations. I had one of my machines going and I wanted to see if I could get it in tune with the vibration of the building. I put it up notch after notch. There was a peculiar cracking sound. "I asked my assistants where did the sound come from. They did not know. I put the machine up a few more notches. There was a louder cracking sound. I knew I was approaching the vibration of the steel building. I pushed the machine a little higher. "Suddenly all the heavy machinery in the place was flying around. I grabbed a hammer and broke the machine. The building would have been about our ears in another few minutes. Outside in the street there was pandemonium. "The police and ambulances arrived. I told my assistants to say nothing. We told the police it must have been an earthquake. That's all they ever knew about it." Some shrewd reporter asked Dr. Tesla at this point what he would need to destroy the Empire State Building and the doctor replied: "Vibration will do anything. It would only be necessary to step up the vibrations of the machine to fit the natural vibration of the building and the building would come crashing down. That's why soldiers break step crossing a bridge." His early experiments in vibration, he explained, led to his invention of his "earth vibrating" machine.

The Tesla Disc Turbine

by W. M. J. Cairns

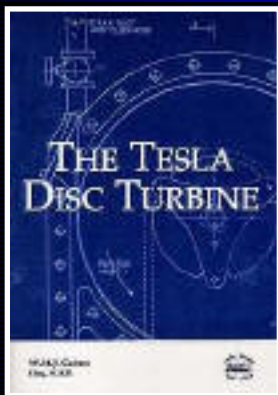

"This book describes the concept of the Disc Turbine as originally patented by Nicola Tesla, and provides concept designs for modern versions of the engine, incorporating the Disc Turbine as a power unit for applications in Automobiles and Light Aircraft, and also give descriptions of the original Turbines and the prototype machines. It also provides designs for other machines operating on the principle of a disc turbine: an Air Compressor, an Air Motor, and a Vacuum Exhauster. The facility of the principle to operate in either a clockwise or anti-clockwise direction of rotation, in a single machine, using only a two-way valve, is described, and

applications where this feature can be applied to advantage are suggested.

Data is given on the performances attained by the original engines, together with stress and performance information. Finally, we give a design for a modernized version of the original turbine, to one half scale, complete with working drawings and manufacturing instructions to enable the model or experimental engineer to construct a fully operational engine, using such tools and equipment as are usually available to model makers.

It should be apparent that this dry foreword written by the author sounds like the abstract of a paper published in a professional engineering journal. That's because the author IS an engineer who has a number of published papers. Cairns is no novice. He knows what he's talking about. Chapters include: Tesla's original machine * The Disc Turbine Operating Principle * The first experimental Turbine * The 9.75 in. Disc Prototype Turbine * Larger Turbines to 60 in. disc diameter * Future developments * Other Rotary Engines * The Automotive Disc Turbine * Air Compressor, Vacuum Pump, Air Motor, Light Aircraft Engines * The Dual Direction Facility * Stresses in the discs and performance calculations * Building a model Disc Turbine * Drawings for a model Disc Turbine* Since this is a 36 page "booklet" each "chapter" is necessarily short. But what you DO get is loaded with valuable information. Remember this is written by an engineer who is interested in getting results. The last nine pages are dedicated to the model with six pages of detailed, dimensioned drawings. The model described is approximately one half the size of the original Tesla unit, but uses present-day materials and techniques... Required machine tools are a lathe, with a 3.5" centre height, ideally with a milling attachment, and circular table, a bench drill, micrometer or vernier, and conventional hand tools (metric dimensions are used)

From the testing section: "Run for no more than two minutes, stop, check the housing temperature. If cool to slightly warm, re-open the valve and continue running. At around 1.75 bar and 1.5 cfm, the turbine will attain a shaft speed of 20,000 R.P.M. At all times ensure a supply of oil to the bearings, and continually monitor the housing temperature. It should be noted that the prototype attained a speed of approximately 50,000 R.P.M. under no-load conditions; hence it is advised that a brake or dynamometer be provided on the shaft."



Tesla : Man Out of Time ~ Usually ships in 24 hours... Margaret Cheney / Mass Market Paperback / Published 1993 Our Price: \$5.59 ~ You Save: \$1.40 (20%)
Synopsis : Portrays the trailblazing nineteenth-century inventor, the man who introduced the fundamentals of robot and computer and missile science and who harnessed the alternating electrical current used today. Reprint.

This is quite literally my favorite of all of the Tesla Bios. It is loaded with info that is not only verifiable, but thoroughly enjoyable to read. FDG.

Colorado Springs Notes 1899-1900 Nikola Tesla / Hardcover / Published 1978 Our Price: \$40.00 (Special Order)

Dr Nikola Tesla Complete Patents, by John Ratzlaff / Spiral-bound or hardcover/ Published 1983

Our Price: \$35.00 (Back Ordered)

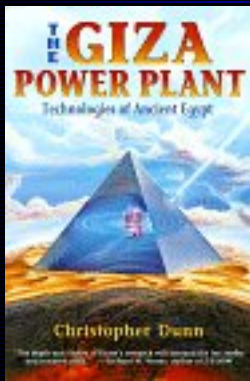

The Giza Power Plant; Technologies of Ancient Egypt: by Christopher Dunn

Our Price: \$14.40...Paperback - (September 1998) 281 pages; Editorial Reviews : Suspicion naturally arises when you read a promo line on a back cover that says, "This is the most important book concerning the Great Pyramid written in the last 20 years." In this case, however, it may be fact. In writing *The Giza Power Plant*, mechanical engineer Christopher Dunn reverse-engineered the Great Pyramid at Giza to discover its use. His startling conclusions blow the heck out of traditional Egyptology's rather silly notions that it was built with copper tools by a society that

lacked the wheel. While revisionist pyramid studies are rife with ridiculous theories that give the topic a bad name, *The Giza Power Plant* takes into account existing fact and artifact without having to rely on un-provable assertions. A must-read for truth seekers who aren't afraid to consider the idea that Western culture of the 21st century may not be the pinnacle of human evolution and achievement. --P. Randall Cohan. The author, Christopher Dunn (cdunn1546@aol.com) , August 22, 1998. *The Giza Power Plant* comes of age. This work was started in September 1977 and will be of age when it becomes available for purchase. The book addresses the feasibility of the pyramids as tombs theory and presents hard evidence that proves that the ancient Egyptians were much more advanced than we have previously believed. So advanced, in fact, that they created stunning artifacts that we would have difficulty producing even today! *The Giza Power Plant* presents ample evidence that many stone artifacts found in Egypt could only have been produced using highly precise and sophisticated machine tools. The question then becomes, "what powered these machine tools and where is their power source?" To answer this question we delve into the Great Pyramid of Giza with a thorough analysis of its inner chambers, architectural and construction characteristics, anomalous substances, and unusual artifacts carelessly noted or closely scrutinized by researchers in the past. This analysis leads us to the conclusion that the Great Pyramid was actually built to serve as a machine. A machine that provided power to the civilization that built it and invested so much time and energy. How did it do this? By responding harmonically with the seismic energy contained within the Earth, the Great Pyramid became a coupled oscillator and drew energy through it and converted it to electromagnetic energy through the sophisticated use of acoustics and quartz-bearing rock.

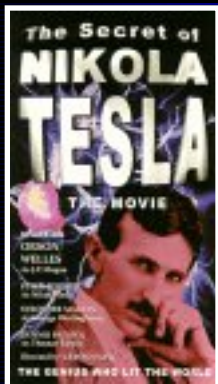

Secret of Nikola Tesla VHS TAPE!

Special Order: \$29.95

"The Secret of Nikola Tesla" is a film about a man that was so far beyond his time in the field of electronics that people today still haven't understood what impact his discoveries have on their lives today. Things in this world would be radically different if Tesla was allowed to complete his work. In this video, you will get a feel for the passion and incredible intellect that Tesla possessed. Don't be surprised if you get a little "peeved" after finding out that many of our world's problems have already been answered, but because of the "Almighty Dollar" our wellbeing has been neglected. Tesla foresaw all of it. This film is a

must for everyone. We can learn from history, and this film details important little known facts. Though it is not perfect in it's portrayal, "The Secret of Nikola Tesla" stands as a landmark film...it's well worth your time to view it.

Secrets of Cold War Technology: Project HAARP and Beyond, by Gerry Vassilatos, Our Price:

\$15.95 Now, Free Shipping!

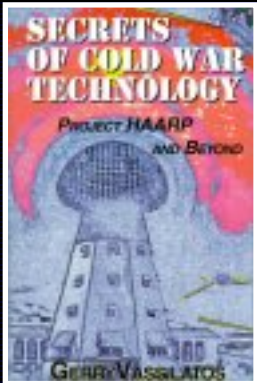

Editorial Reviews: Book Description : In Secrets of Cold War Technology, Gerry Vassilatos reveals that "Death Ray" technology has been secretly researched and developed since the turn of the century. Included are chapters on H. C. Vion, the developer of auroral energy receivers; Dr. Selim Lemstrom's pre-Tesla experiments; the early beam weapons of Grindell-Mathews; John Hettenger and his early beam power systems; Ulivi Turpain and others. Learn about Project Argus, Project Teak and Project Orange; EMP experiments back in the '60s; why the Air Force directed

the construction of a huge ionospheric "backscatter" telemetry system across the Pacific just after World War II; why Raytheon has collected every patent relevant to HAARP over the past few years; and much more pertinent information on hidden Cold War technology. About the Author : Gerry Vassilatos is a high school science teacher who lives in New York City. He is the author of The Lost Science, another forthcoming book from Adventures Unlimited.

Dr. Nikola Tesla : Complete Patents John T. Ratzlaff / Hardcover / Published 1981 Our Price: \$40.00

(Special Order) All of Tesla's US and British and Canadian patents are listed, on either book, or CD-ROM. This is an invaluable tool for any serious study on Dr. Nikola Tesla.

Dr. Nikola Tesla Bibliography: John T. Ratzlaff, Leland I. Anderson / Hardcover Our Price:

\$24.95 (Special Order)

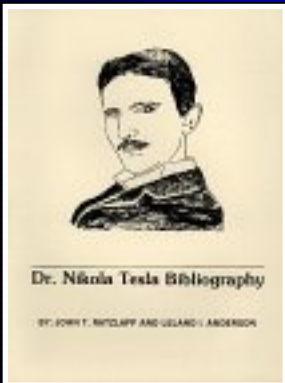

Dr. Nikola Tesla Bibliography, by John T. Ratzlaff, John T. Ratzlaff, Leland I. Anderson, List Price: \$24.95, Our Price: \$24.95 + \$1.99 sourcing fee, Now, Free Shipping! Availability: This title usually ships within 4-6 weeks. Please note that titles occasionally go out of print or publishers run out of stock. We will notify you within 2-3 weeks if we have trouble obtaining this title. Spiral-bound - (July 1995)
Editorial Reviews

Antique Wireless Association Bulletin, December 1980 "One of the best bibliographies I have seen on anyone... Every Tesla buff should have a copy... If anyone had doubts about Tesla's contribution to radio and electricity...this should satisfy them.... Book Description : First published in 1979, this is the second printing of an exhaustive annotated bibliography of writings by and about the inventor Nikola Tesla (1856-1943). The period covered is from 1884 through 1978 with approximately 3,000 citations arranged in chronological order. In compiling this edition, all earlier bibliographical efforts were merged, with both North American and European sources being cited. In addition to searching periodical directories and newspaper indexes, complete runs of 23 serials were examined for content; morgue files were examined for unindexed newspapers; Tesla's estate papers were examined for reference to obscure published articles; clipping files in major institutional and public libraries were examined. The end result is a major work that to this day serves as an aid to the user in following the sequence of

Tesla's life, scientific discoveries, and accomplishments



Genius Who Lit the World Nikola Tesla / VHS Tape / Published 1998 Our Price: \$24.95 (Special Order) VIDEO...THIS is a "must see"...120 minutes of absolute Tesla... very highly recommended. You will have new-found insight into the world of Nikola Tesla after watching this video, so be warned!! Tesla's life, work and legacy are documented in this rare portrait of the man whose accomplishments including his invention in 1888 of the alternating current motor were long overshadowed by others. visit the Tesla museum in Belgrad, and see the full range of his work. 120 minutes.

Phenomenon:Lost Archives Nikola Tesla: VHS tape



List Price: \$14.99

Price: \$14.99



Introducing Nikola Tesla Through Some of His Achievements: by John J.

O'Neil / Paperback / Published 1992 Our Price: \$12.00 (Special Order)

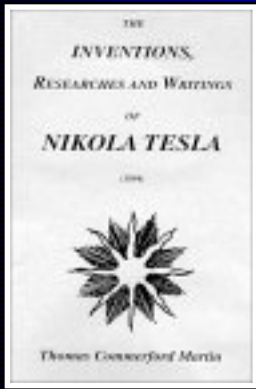

[Inventions Researches and Writings of Nikola Tesla T. Martin / Hardcover / Published 1988 Our Price: \\$18.95 \(Special Order\) Editorial Reviews, Book Description](#) :Probably the most comprehensive book about Tesla s work and fully illustrated! From the Publisher Kessinger Publishing reprints over 1,500 similar titles all available through Amazon.com.

[The Inventions, Researches and Writings of Nikola Tesla - 1894 Thomas C. Martin / Paperback / Published 1997 Our Price: \\$39.00 \(Special Order\)](#)

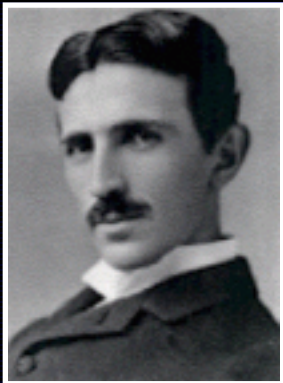

[Tesla: The Complete Patents:](#)

[Editorial Reviews; Book Description](#) : This CD-ROM the most complete set of Tesla's Patents available to date! This set is truly unique in that it includes Canadian, Great Britain, as well as all his U.S. Patents, including one reissue.

This edition includes... -Complete Patents include; abstracts, descriptions, text, drawings, and claims in .pdf format... you get the entire patents! -Acrobat Reader - Win95 or Mac -FBI files compiled on Tesla in .txt and .pdf formats -Biography on Tesla in .txt format -Tesla autobiography in .txt format -1943 Marconi vs. Tesla court case. -Lists of ALL his patents compiled chronologically in easy html format -Many articles on Tesla and his experiments -Formulas & calculators for building your own Tesla-coil projects -Photos of Tesla, The Tesla museum, coils & schematics -Short .avi and .mov movie files -Jammed packed with many more goodies!From the Publisher ; Collected and placed on CD-ROM by Internationally recognized alternative energy researcher Bruce A. Perreault, in pdf format.

[Nikola Tesla - Lectures, Patents, Articles Paperback / Published 1992, buy the Tesla Museum Staff, Our Price: \\$89.50.00 \(Special Order\)](#)

[Nikola Tesla : Free Energy and the White Dove, by Commander X / Paperback / Published](#)

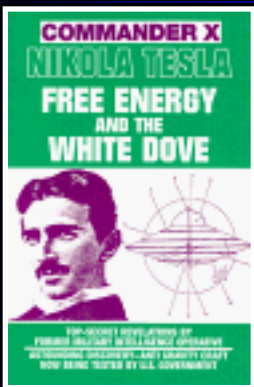

1992 Our Price: \$10.95 (Special Order)

THE NEW AGE VERSION OF TESLA'S LIFE, January 9, 2001 THIS BOOK IS ONE OF A KIND. . . I have been privileged to read many books on the life of Nikola Tesla. This is one of the few that delve into the unusual aspects of Tesla's life. The author -- a retired military intelligent officer -- did a background check and found out that Tesla had quite an unusual birth. He suggests that Nikola was actually a highly advanced space being who was reincarnated in an earthly body and left on the doorstep of the couple who raised him. We find that Tesla did have among his friends an inventor

from Baltimore by the name of Otis T. Carr who in the 1960s constructed his own anti gravity device which he claimed could fly to the moon. He supposed met Tesla many times in the hotel where Tesla lived during the last years of his life. We are treated to many insightful bits of information that have not been published elsewhere. This is a very readable book which anyone who is interested in Tesla's life -- and not so much technical information and patent information which can be found in hundred of other texts -- will find of great benefit. Exposes the most important alternative scientific advancements of our time utilizing free energy which was uncovered by Tesla and perhaps derived from other worldly sources.t.



Nikola Tesla : Guided Weapons, Computer Technology & High Voltage

Resonators (Tesla Presents Series, Pt. 3) Nikola Tesla, et al / Hardcover /

Published 1998 Our Price: \$32.00: Editorial Reviews: This work, the third installment of the Tesla Presents series, is based upon legal records associated with the Nikola Tesla vs. Reginald A. Fessenden Patent Interference on the Fundamental AND-Gate logic circuit. While the U.S. Patent Office record is sufficiently important on the basis of its title alone, Tesla winning the claim to this invention, surprisingly the deposition contains heretofore unpublished disclosures by Tesla on the operation of his large high frequency resonators at both the Houston Street laboratory in New York and the

Experimental Station in Colorado. Information is presented on what Tesla spoke of as the "art of individualization" for obtaining various levels of security in wireless transmissions. Also included is material on the history of radio-controlled devices, the first practical form of these being Tesla's radio-controlled "teleautomaton" - an operational boat first demonstrated to the public at Madison Square Garden in 1898.

Excerpted from Nikola Tesla : Guided Weapons, Computer Technology & High Voltage Resonators (Tesla Presents Series, Pt. 3) by Nikola Tesla and Leland I. Anderson. Copyright © 1998. Reprinted by permission. All rights reserved. In his laboratory on South Fifth Avenue (now West Broadway) in New York City, Tesla began work in the 1890s on the construction of remote-controlled devices, or "telautomatons," as he referred to them. This work evolved from his investigations in 1893 of automatic mechanisms actuated from a distance. Tesla performed experiments with tuned devices (secondary-actuated) that would respond by induction to an oscillator primary coil running up and around the cove in the experimental area of the...(Tesla Presents Series, Pt. 3)

Tesla: Master Of Lightning: Price - \$12.95 VHS tape

THIS PBS HOME VIDEO, ABOUT 90 MINUTES LONG, DOES A WONDERFUL JOB OF CONVEYING THE GENIUS THAT WAS NIKOLA TESLA. THIS IS THE BEST AND MOST WELL BALANCED VIDEO I'VE SEEN ON THE LIFE AND ACCOMPLISHMENTS OF AMERICA'S PREMIER UNDERRATED SCIENTIST/ INVENTOR. WATCH THIS TAPE AND THEN LOOK AROUND THE HOUSE. YOU'LL BE AMAZED IN THE WAYS IN WHICH TESLA TOUCHES OUR EVERYDAY LIVES. IT'S ABOUT TIME HE RECEIVES THE OVERDUE RECOGNITION HE DESERVES.

NOT TO BE MISSED.

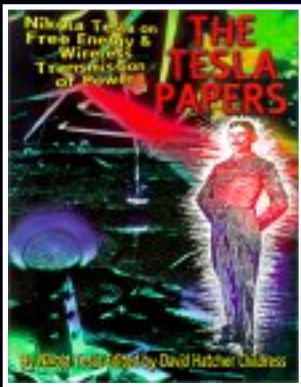
**The Tesla Papers: by Nikola Tesla, David Hatcher Childress: Editorial Reviews**

Book Description : In the tradition of *The Fantastic Inventions of Nikola Tesla*, *The Anti-Gravity Handbook* and *The Free-Energy Device Handbook*, science and UFO author David Hatcher Childress takes us into the incredible world of Nikola Tesla and his amazing inventions. Tesla's rare article "The Problem of Increasing Human Energy with Special Reference to the Harnessing of the Sun's Energy"-originally published in the June 1900

issue of *The Century Illustrated Monthly Magazine*-was the master blueprint for his fantastic vision of the future, including wireless power, anti-gravity, free energy and highly advanced solar power. Also included are papers, patents and material collected on Tesla at the Colorado Springs Tesla Symposia, including papers on:
 the secret history of wireless transmission
 Tesla and the magnifying transmitter*
 design and construction of a half-wave Tesla coil*
 electrostatics: a key to free energy-Tesla's particle beam technology
 An eccentric visionary and one of the greatest scientific innovators, Tesla's created inventions that power today's world. What was his vision of tomorrow? Find out in *The Tesla Papers!*
About the Author : David Hatcher Childress is an internationally known science, archeology and UFO writer. He has appeared on various television shows worldwide, including an NBC special on Atlantis, the NBC special *Mysterious Origins of Man*, *Sightings* and *The Today Show*. He is the author of more than 16 books, a number of which have been translated into foreign languages. He lives near Chicago.

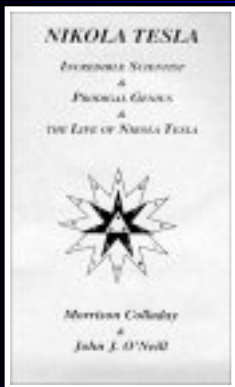

Nikola Tesla : Incredible Scientist & Prodigious Genius : The Life of Nikola, by Tesla Morrison Colladay, John J. O'Neill / Paperback / Published 1997 Our Price: \$12.95 (Special Order)

Editorial Reviews: Book Description

Nikola Tesla: Incredible Scientist, and article from the American Mercury, June 59; Illustrations of patents; Tesla stamps; Articles & pictures from the book Lightning in His Hands; Bibliography of books & articles on Tesla; Prodigious Genius. A Man's Story, not just the Science., June 1, 2001. Unlike the other review I read on this page I find this an Incredible Book. I first read it as a teen and was inspired by the story of an inventor who never has been truly admired by the mainstream. His rivalry with Edison, his failure in love and his unusual mental talents all combine to create an extraordinary story of a man who appears more like an Extraterrestrial than human. The book isn't full of pictures... because not many exist, but if you can aspire to your imagination and delve into O'Neill's description of this man you'll find it all amazing. I've come back to this book again and again... for the story and not necessarily the physics.



Nikola Tesla : Lecture Before the New York Academy of Sciences April 6, 1897 : The Streams of Lenard and Roentgen and Novel Apparatus for Their Prods ~ Usually ships in 24 hours Nikola Tesla, Leland I. Anderson (Editor) / Hardcover / Published 1994 Our Price: \$21.95

Editorial Reviews: CHOICE, July/August 1995, Vol. 32, No. 11/12: "Tesla's lecture of 1897 was never published in full. In this monograph..., Anderson has reconstructed the lecture from a partial typescript and from two articles by Tesla in the May 5 and August 11, 1997, issues of Electrical Review (N.Y.). Tesla begins by recounting his observations of emanations from dozens of differently designed Crooks tubes using a variety of powerful high frequency supplies of his own design... He provided evidence that Roentgen-rays were produced where the cathode rays first struck, e.g., the glass wall of the vacuum tube... In "The Hurtful Actions of Lenard and Roentgen Tubes," Tesla describes his own experiences with damage to the skin produced by both, and includes sensible advice for minimizing the damage. In addition to its historical interest, Tesla's presentation of experiments that revolutionized physical science provides a fascinating view of the analogies and metaphors guiding the thoughts of one important contributor to the revolution." Book Description : Following Nikola Tesla On His Work With Alternating Currents, this book is the second in a three part Tesla Presents series offering the reader what has been, up until now, unavailable material on the pioneering work of Nikola Tesla in field of radio frequency electrical engineering. While first delivered under the title "On the Streams of Lenard and Roentgen with Novel Apparatus for Their Use" the information carried within the text of the lecture goes far beyond this topic.



Nikola Tesla On His Work With Alternating Currents and Their Application to Wireless Telegraphy, Telephony, and Transmission of Power... Nikola Tesla / Spiral-bound Our Price: \$26.95 (Special Order)

Editorial Reviews : Society for the History of Technology, Antenna Newsletter, December 1992, page 3 : "This material provides both technical and anecdotal evidence on Tesla's experiments with and applications of wireless telegraphy and

telephony. In addition to their new data, these transcripts also provide readers with a different sense of Tesla's personality. QST, March 1995, page 116 : "The subject of this book is a collection of Interviews conducted with Tesla by his legal counsel in 1916. The Marconi Wireless Telegraph Co. sought to trample all competition by patenting every device used in radio communication. Tesla was interviewed to document his prior work and accomplishments, and thus protect them from rapacious Marconi Co. Although the interview took place over seven days, the editor has assembled the transcript into a contiguous document... And what a document! Tesla well knew what fascinating work he was doing, and you can sense his enthusiasm as he describes apparatus capable of generating tens of thousands of volts and drawing sparks 135 feet long. Indeed, one of his goals was to broadcast energy through the air, rather than via wires... reduce the power and modulate the wave and you have radio...Nature, June 17, 1993, Vol. 363, page 592. : "The fledgling broadcast industry of the early 1900s was blighted by fierce patent litigations. Patents in this highly innovative field were often loosely formulated and most wireless systems contained devices whose patents were held by several inventors or Entrepreneurs. One of the most charismatic of these people was Nikola Tesla... This document, never intended for publication, is a transcript of a pre-hearing interview with Tesla by his legal counsel in 1916... Tesla gives a fascinating account of the stages that led him in the 1890s to attempt to transmit electrical power through the earth without the use of wires. Book Description : In this recently discovered transcript of a three day interview conducted in 1916, Nikola Tesla, using words and graphic illustrations, provides a step by step description of his remarkable accomplishments in the area of radio frequency engineering. In a style uniquely his own, Tesla carefully traces his work - from the first high frequency alternators constructed at his New York City Grand Street laboratory and their associated tuned circuits through the establishment of his huge broadcasting facility, the Wardencllyffe Plant, at Shoreham, Long Island. Among the variety of topics discussed are: high frequency alternators, experiments with wireless telegraphy and telephony, mechanical and electrical oscillators, the Colorado experiments, theory and technique of energy transmission, the Long Island plant, and arrangements for receiving. Seldom, in technical research, has such a treasure of descriptive commentary and historical documentation been discovered. The previously untold story found within the pages of this remarkable book has been described by the prominent Tesla researcher James Corum as a "veritable Rosetta stone" for tracing the technical thoughts of one of our most distinguished engineering scientists. Includes 61 photos and 42 line-art illustrations, many never before published.

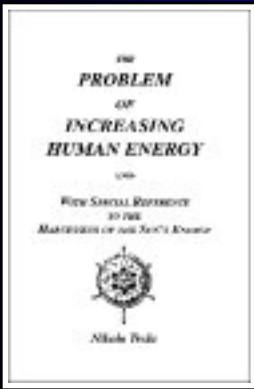

[The Problem of Increasing Human Energy ~ Usually ships in 24 hours Nikola Tesla / Paperback / Published 1990 Our Price: \\$9.95 + \\$0.85 special surcharge](#)

[The Problem of Increasing Human Energy - 1900 Nikola Tesla / Paperback / Published 1997 Our Price: \\$12.95 \(Special Order\), by Nikola Tesla Our Price: \\$12.95 Used Price: \\$10.36 Availability: This title usually ships within 4-6 weeks. Please note that titles occasionally go out of print or publishers run out of stock. We will notify you within 2-3 weeks if we have trouble obtaining this title.](#)

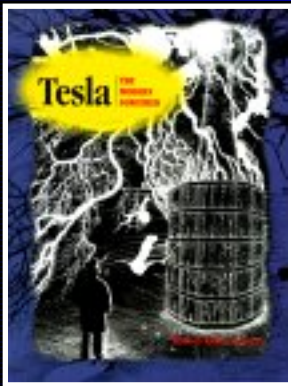

TESLA: The Modern Sorcerer. by Blaire Stewart

[Editorial Reviews Book Description:With more than 100 patents, electrical engineer Nikola Tesla rivaled Thomas Edison as one of our greatest scientists. This biography, notable for its anecdotal detail and extensive dialogue from original documents, reflects the author's thorough research. Often overlooked as a subject of study in primary schools, Tesla was a leader in electrical innovation whose inventions include the induction motor, alternating-current power transmission, and the radio.](#)

[The author, Daniel Blair Stewart , September 2, 1999. TESLA AS WIZARD: When science and sorcery were one. My fascination with Tesla goes back to my childhood. As much as I had read about the development of alternating current or his experiments with giant Tesla coils, I still did not realize that he ruled a lost age of wonders, forgotten for nearly a century, but which demands our attention today. I chose to write an illustrated novel to fill in the blanks left by his biographers, to flesh out his eccentric personality and feed the eye visions of his wonders, created by his hand and made to live by...](#)

[Prodigal Genius : The Life of Nikola Tesla John J. O'Neill / Paperback / Published 1994 Our Price: \\$12.99 \(One of the BEST Tesla books of all time!\) As far as Tesla biographies go, this one is usually ranked as better than others. You will often see references and quotes listed by John O'Neill in just about every Tesla literature that there is. For under \\$13.00, how can you go wrong?](#)

[Selected Patent Wrappers from the National Archives Nikola Tesla / Spiral-bound / Published 1981 Our Price: \\$65.00 \(Special Order\)](#)

The Solution to Tesla's Secrets and the Soviet Tesla Weapons, Part I :

Reference Articles for Solution to Tesla's Secrets, Part II T. E. Bearden / Spiral-bound / Published 1981 Our Price: \$14.00

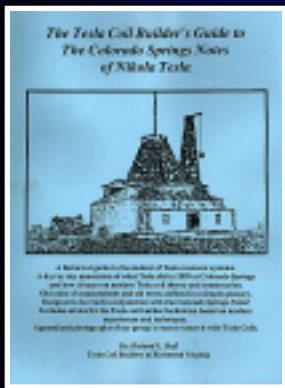
**The Tesla Coil Builder's Guide to the Colorado Springs Notes of Nikola Tesla**

Richard L. Hull / Spiral-bound / Published 1994 Our Price: \$27.50 (Special Order)

Reviews : The author, Richard L. Hull , May 14, 1997 What this book is about, and

Who it is written for. The "Colorado Spring Notes" - No lit, are a collection of daily

scientific journal entries written by Nikola Tesla during his experimentation with

high voltage electrical resonant systems while in Colorado in 1899. This book is

written specifically for the advancing Tesla coil builder who has a copy of the

Colorado Springs Notes and finds them mysterious or disjoint. It is aimed at

clearing up some of the unclear language and units used by Tesla in the late 19th

century. His commentary is reviewed on a day by day basis and those items which

relate to the modern tesla coil builder are made plain in modern scientific verbiage using more modern

units of electrical measure. Owning the original Colorado Springs Notes is not really necessary, as the

book is written in a flowing format which is self contained. If the reader has the notes he can, of course,

cross reference the author's commentary on a daily basis. This is also a historical work and relates

Tesla's separate, private correspondence to his secretary in New York, George Schreff, to

advancements and day to day business during Tesla's stay in Colorado. The real history of Tesla's

incredible work in 1899 is revealed without the hype and magnification found in so many modern works

on the man. The author's own experience and work with real Tesla coils, including the magnifying

transmitter, is covered in a series of monographs and reprinted articles in the large appendix following

the main work. Finally, a large number of large photographs of real working systems are included in a

"photo section" at the very end of the book. These follow the work of the author's group, The Tesla Coil

Builders of Richmond, from 1990 up to late 1996 in the third printing.

[Tesla Said](#) Nikola Tesla, John T. Ratzlaff (Compiler) / Paperback / Published



1984 Our Price: \$28.00 (Back Ordered) THIS is the book you want to read if you are interested in knowing EXACTLY what Nikola Tesla "said," and not some "colored" version from inferior biographical authors...Ratzlaff has researched every known media for text and documents on the interviews, writings, publications, etc...and is THE source for information regarding everything pertinent to Dr. Nikola Tesla...highly recommended.

[BACK TO STORE'S INDEX](#)

[SITE INDEX](#)

[HOME](#)

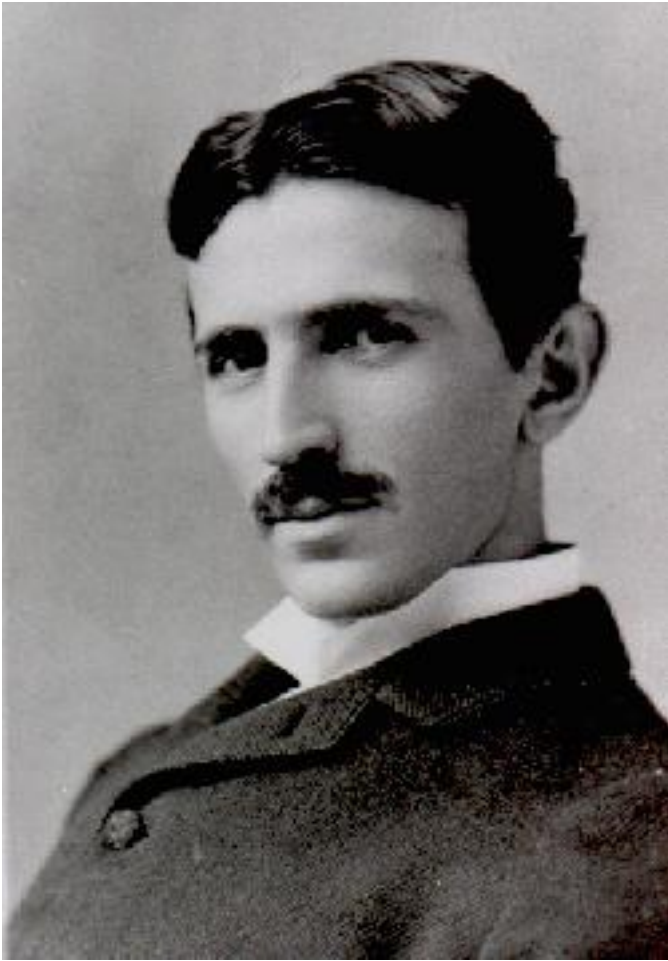

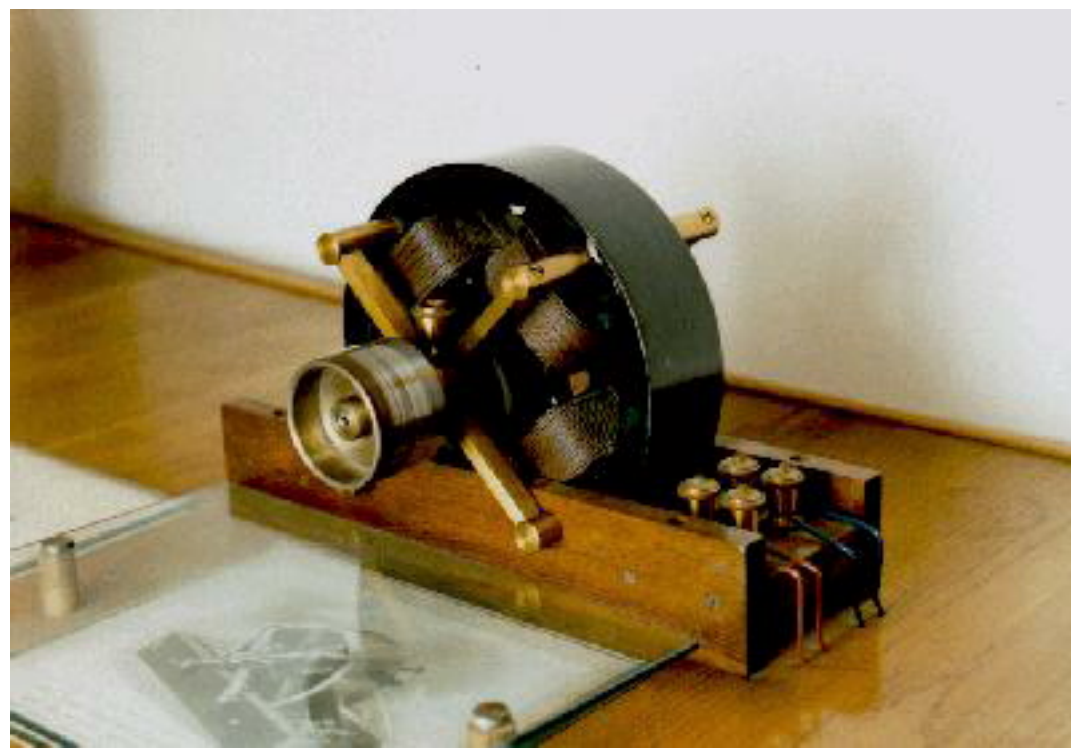

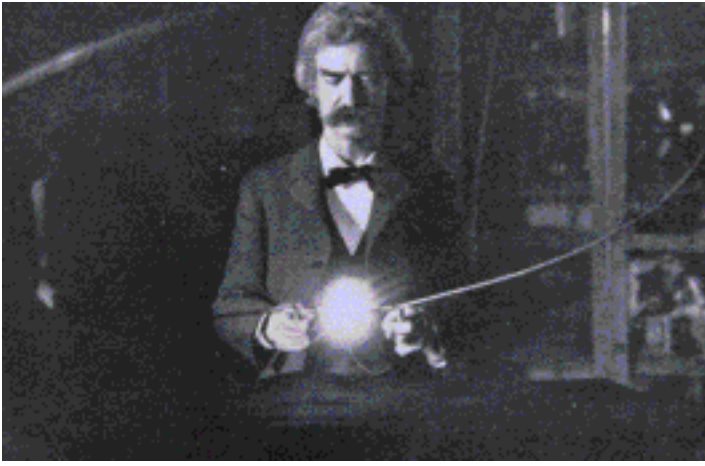

" Tesla's Bladeless Boundary Disk Turbine and Pump "

This page will give you one of the most comprehensive historical perspectives of Nikola Tesla's turbine and pump found on the web.
It is a pretty large page...let it load fully.

[INDEX](#) to the Frank.Germano.com website

[Help Frank Germano](#) bring this technology to the world!

[Would you like to see what Frank Germano has done with Nikola Tesla's turbine? Click here.](#)

Historical Background of the Tesla Turbine and Pump

Here is an abstract from US patent # 1,329,559, issued to Nicola Tesla in 1916.

It covers the Internal Combustion version of Tesla's Turbine .

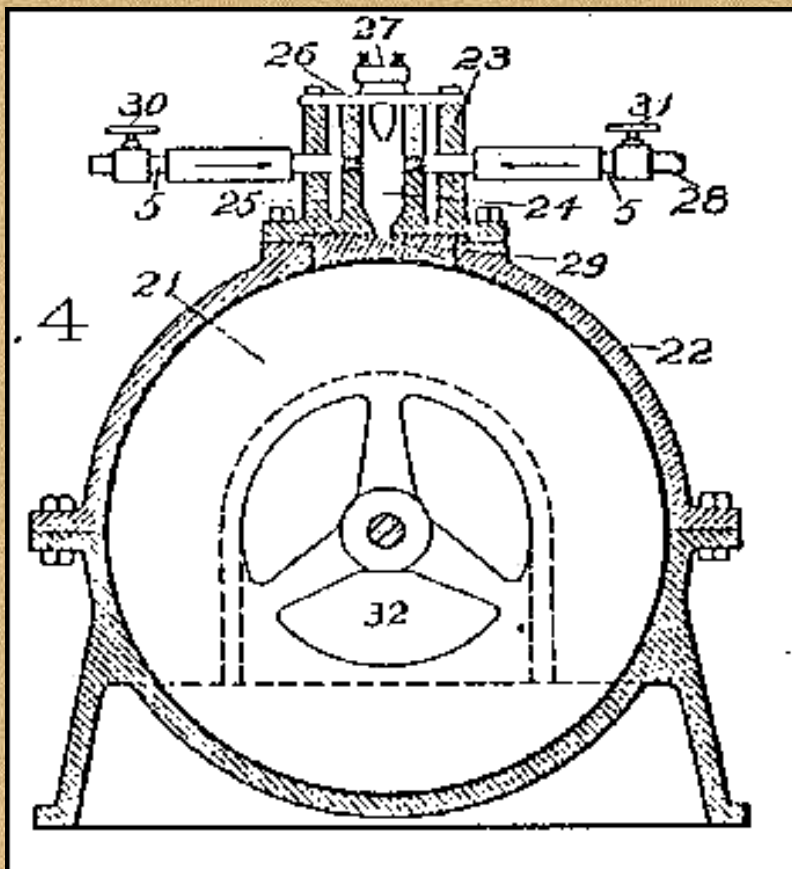

Tesla's Valvular Conduit Patent: Fig. 4 (left) exemplifies a particularly valuable application of the invention to which reference has been made above. The drawing shows in vertical cross section a turbine which may be of any type but is in this instance one invented and described by me and supposed to be familiar to engineers.

Suffice it to state that the rotor 21 of the same is composed of flat plates which are set in motion through the adhesive and viscous action of the working fluid, entering the system tangentially at the periphery and leaving it at the center.

Such a machine is a thermodynamic transformer of an activity surpassing by far that of any other prime mover, it being demonstrated in practice that each single disk of the rotor is capable of performing as much work as a whole bucket-wheel.

Besides, a number of other advantages, equally important, make it especially adapted for operation

as an internal combustion motor.

This may be done in many ways, but the simplest and most direct plan of which I am aware is the one

illustrated here. Referring again to the drawing, the upper part of the turbine casing 22 has bolted to it a separate casting 23, the central cavity 24 of which forms the combustion chamber.

To prevent injury through excessive heating a jacket 25 may be used, or else water injected, and when these means are objectionable recourse may be had to air cooling, this all the more readily as very high temperatures are practicable. The top of casting 23 is closed by a plate 26 with a sparking or hot wire plug 27 and in its sides are screwed two valvular conduits communicating with the central chamber 24. One of these is, normally, open to the atmosphere while the other connects to a source of fuel supply as a gas main 28. The bottom of the combustion chamber terminates in a suitable nozzle 29 which consists of separate piece of heat resisting material. To regulate the influx of the explosion constituents and secure the proper mixture of air and gas conduits are equipped, respectively, with valves 30 and 31. The exhaust openings 32 of the rotor should be in communication with a ventilator, preferably carried on the same shaft and of any suitable construction. Its use, however, while advantageous, is not indispensable the suction produced by the turbine rotor itself being, in some cases, at least, sufficient to insure proper working. This detail is omitted from the drawing as unessential to the understanding. But a few words will be needed to make clear the mode of operation. The air valve 30 being open and sparking established across terminals 27, the gas is turned on slowly until the mixture in the chamber 24 reaches the critical state and is ignited. Both the conduits behaving, with respect to influx, as closed valves, the products of combustion rush out through the nozzle 29 acquiring still greater velocity by expansion and, imparting their momentum to the rotor 21, start it from rest.

Upon the subsidence of the explosion the pressure in the chamber sinks below the atmosphere owing to the pumping action of the rotor or ventilator and new air and gas is permitted to enter, cleaning the cavity and channels and making up a fresh mixture which is detonated as before, and so on, the successive impulses of the working fluid producing an almost continuous rotary effort. After a short lapse of time the chamber becomes heated to such a degree that the ignition device may be shut off without disturbing the established regime. This manner of starting the turbine involves the employment of an unduly large combustion chamber which is not commendable from the economic point of view, for not only does it entail increased heat losses but the explosions cannot be made to follow one another with such rapidity as would be desirable to insure the best valvular action. When the chamber is small an auxiliary means for starting, as compressed air, may be resorted to and a very quick succession of explosions can then be obtained.

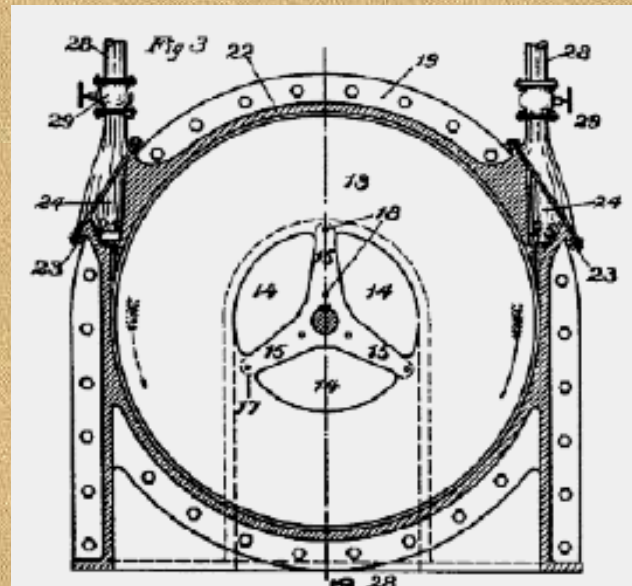

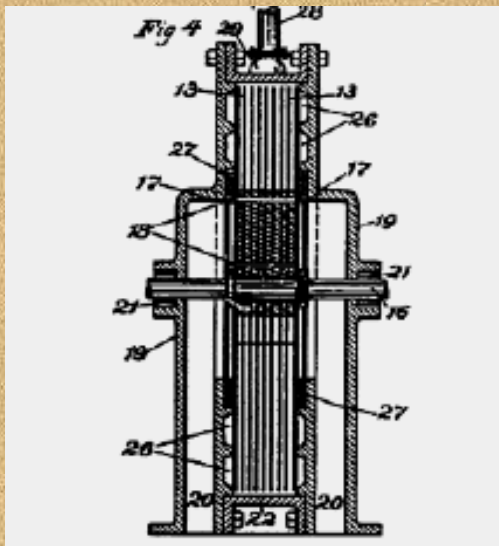

The frequency will be the greater the stronger the suction, and may, under certain conditions, reach hundreds and even thousands per second. It scarcely need be stated that instead of one, several explosion chambers may be used for cooling purposes and also to increase the number of active pulses and the output of the machine. Apparatus as illustrated in Fig. 4 presents the advantages of extreme simplicity, cheapness and reliability, there being no compressor, buckets or troublesome valve mechanism. It also permits, with the addition of certain well known accessories, the use of any kind of fuel and thus meets the pressing necessity of a self-contained, powerful, light and compact internal combustion motor for general work. When the attainment of the highest efficiency is the chief object, as in machines of large size, the explosive constituents will be supplied under high pressure and provision

made for maintaining a vacuum at the exhaust. Such arrangements are quite familiar and lend themselves so easily to this improvement that an enlargement on this subject is deemed unnecessary...

The high efficiency of the device, irrespective of the character of the pulses, is due to two causes: first, rapid reversal of direction of flow and, second, great relative velocity of the colliding fluid columns. As will be readily seen each bucket causes a deviation through an angle of 180 degrees, and another change of 180 degrees occurs in each of the spaces between two adjacent buckets.

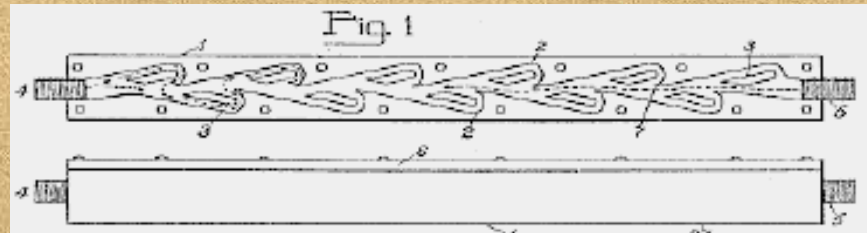

That is to say, from the time the fluid enters or leaves one of the recesses to its passage into, or exit from, the one following a complete cycle, or deflection through 360 degrees, is effected. Observe now that the velocity is but slightly reduced in the reversal so that the incoming and deflected fluid columns meet with a relative speed, twice that of the flow, and the energy of their impact is four times greater than with a deflection of only 90°, as might be obtained with pockets such as have been employed in asymmetrical conduits for various purposes. The fact is, however, that in these such deflection is not secured. the pockets remaining filled with comparatively quiescent fluid and the latter following a winding path of least resistance between the obstacles interposed. In such conduits the action cannot be characterized as "valvular" because some of the fluid can pass almost unimpeded in a direction opposite to the normal flow. In my construction, as above indicated, the resistance in the reverse may be 200 times that in the normal direction. Owing to this a comparatively very small number of buckets or elements is required for checking the fluid.

A NEW ADVANCE IN TESLA TURBINE THEORY

Observant students of the disk turbine design might have wondered why some of Tesla's engines do not appear to use a labyrinth seal between the end disks and the corresponding engine casing end plates. After all, the patent drawings clearly show these seals and the accompanying text describes them at length. At the same time, photographs of the dual 200 H.P. turbine installed at the Edison Waterside plant in New York reveal an absence of this feature.

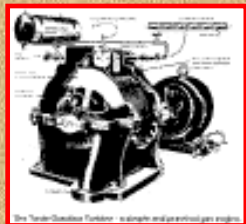

It is believed the answer lies in the design of the engine's inlet nozzle. (click on image - left - for larger view) It has been proposed that the slot shaped nozzle might have been constructed in such a manner that the propelling gas was never allowed to enter directly into the two interdiscular spaces nearest to the ends of the rotor.

In other words, it is believed the nozzle slot was narrower than the overall width of the rotor, by slightly more than two spaces. It might be said that the total number of disks was greater by two than the number of active disks. For example, a turbine with 25 disks, including the thicker end disks, might be described as having 23 active disks. This would allow any of the propelling gas which did get past the outermost active disks to pass through the two outermost interdiscular spaces rather than between the end disks and the engine's end plates.

Tesla's two variations of inlet nozzles

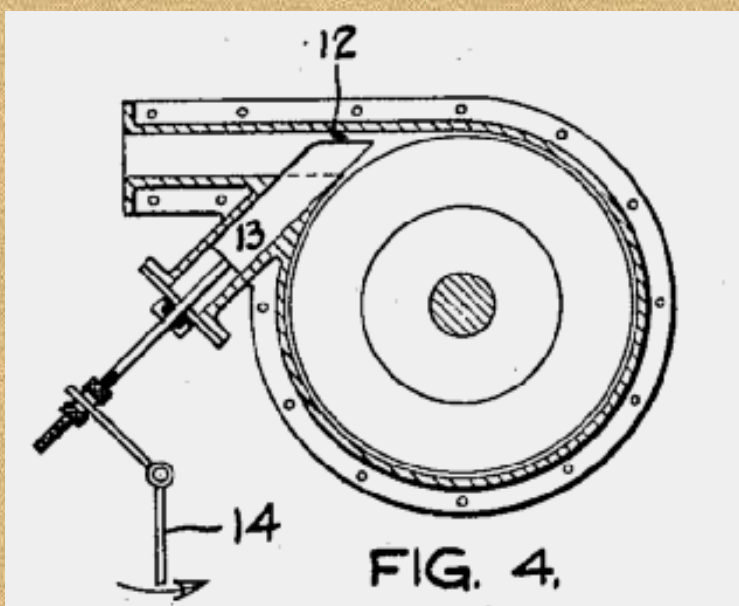

In FIG #4, Tesla used a variable inlet nozzle #12, and controlled the amount of gas entering by a movable "block" - #13.

Note that also, in FIG #4, the inlet and exhaust port size was increased, to allow for more power, on demand.

Tesla, in FIG #5 used a diverging inlet nozzle - #15, controlled by a "butterfly" valve, #16 .

This design was to be incorporated into Tesla's "flying machine", with two 10" turbines, rated at 400 HP.

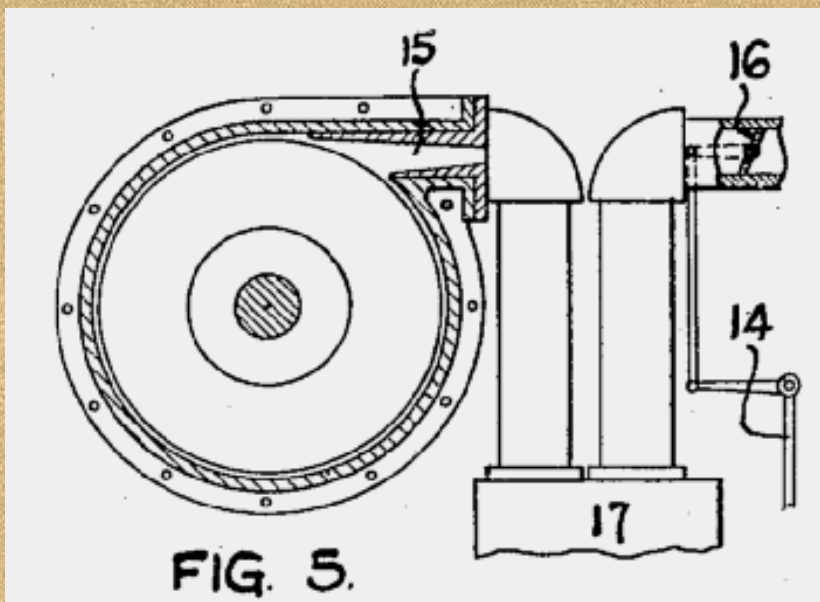

REF: Tesla Patent # 1,655,114 of 1928.

From the "New York Herald Tribune", Oct. 15th 1911

Tesla's New Monarch of Machines

Suppose some one should discover a new mechanical principle--something as fundamental as James Watt's discovery of the expansive power of steam--by the use of which it became possible to build a motor that would give ten horse power for every pound of the engine's weight, a motor so simple that the veriest novice in mechanics could construct it and so elemental that it could not possibly get out of repair. Then suppose that this motor could be run forward or backward at will, that it could be used as either an engine or a pump, that it cost almost nothing to build as compared with any other known form of engine, that it utilized a larger percentage of the available power than any existing machine, and, finally, that it would operate with gas, steam, compressed air or water, any one of them, as its driving power.

It does not take a mechanical expert to imagine the limitless possibilities of such an engine. It takes very little effort to conjure up a picture of a new world of industry and transportation made possible by the invention of such a device. "Revolutionary" seems a mild term to apply to it. That, however, is the word the inventor uses in describing it--Nikola Tesla, the scientist whose electrical discoveries underlie all modern electrical power development, whose experiments and deductions made the wireless telegraph possible, and who now, in the mechanical field, has achieved a triumph even more far reaching than anything he accomplished in electricity.

There is something of the romantic in this discovery of the famous explorer of the hidden realms of knowledge. The pursuit of an ideal is always romantic, and it was in the pursuit of an ideal which he has been seeking twenty years that Dr. Tesla made his great discovery. That ideal is the power to fly--to fly with certainty and absolute safety--not merely to go up in an airplane and take chances on weather conditions, "holes in the air," tornadoes, lightning and the thousand other perils the aviator of today faces, but to fly with the speed and certainty of a cannon ball, with power to overcome any of nature's aerial forces, to start when one pleases, go whither one pleases and alight where one pleases. That has been the aim of Dr. Tesla's life for nearly a quarter of a century. He believes that with the discovery of the principle of his new motor he has solved this problem and that incidentally he has laid the foundations for the most startling new achievements in other mechanical lines.

There was a time when men of science were skeptical--a time when they ridiculed the announcement of revolutionary discoveries. Those were the days when Nikola Tesla, the young scientist from the Balkans, was laughed at when he urged his theories on the engineering world. Times have changed since then, and the "practical" engineer is not so incredulous about "scientific" discoveries. The change came about when young Tesla showed the way by which the power of Niagara Falls could be utilized. The right to divert a portion of the waters of Niagara had been granted; then arose the question of how best to utilize the tremendous power thus made available--how to transmit it to the points where it could be commercially utilized. An international commission sat in London and listened to theories and practical plans for months.

Up to that time the only means of utilizing electric power was the direct current motor, and direct current dynamos big enough to be of practical utility for such a gigantic power development were not feasible. Then came the announcement of young Tesla's discovery of the principle of the alternating current motor. Practical tests showed that it could be built--that it would work. That discovery, at that opportune time, decided the commission. Electricity was determined upon as the means for the transmission of Niagara's power to industry and commerce.

Today a million horse power is developed on the brink of the great cataract, turning the wheels of Buffalo, Rochester, Syracuse and the intervening cities and villages operating close at hand the great new electrochemical industries that the existence of this immense source of power has made possible, while all around the world a thousand waterfalls are working in the service of mankind, sending the power of their "white coal" into remote and almost inaccessible corners of the globe, all because of Nikola Tesla's first great

epoch making discovery.

Today the engineering world listens respectfully when Dr. Tesla speaks. The first announcement of the discovery of his new mechanical principle was made in a technical periodical in mid-September, 1911. Immediately it became the principal topic of discussions wherever engineers met. "It is the greatest invention in a century," wrote one of the foremost American engineers, a man whose name stands close to the top of the list of those who have achieved scientific fame and greatness. "No invention of such importance in the automobile trade has yet been made," declared the editor of one of the leading engineering publications.

Experts in other engineering lines pointed out other applications of the new principle and letters asking for further information poured in on Dr. Tesla from the four quarters of the globe. "Oh, I've had too much publicity," he said, when I telephoned to him to ask for an interview in order to explain his new discovery to the non-technical public. It took a good deal of persuasion before he reluctantly fixed an hour when he would see me, and a good bit more after that before he talked at all freely. When he did speak, however, he opened up vistas of possible applications of the new engine that staggered the imagination of the interviewer.

Looking out over the city from the windows of his office, on the twentieth floor of the Metropolitan Tower, his face lit up as he told of his life dream and its approaching realization, and the listener's fancy could almost see the air full of strange flying craft, while huge steamships propelled at unheard of speeds plough the waters of the North River, automobiles climbed the very face of the Palisades, locomotives of incredible power whisked wheeled palaces many miles a minute and all the discomforts of summer heat vanished as marvelous refrigerating plants reduced the temperature of the whole city to a comfortable maximum--for these were only a few of the suggestions of the limitless possibilities of the latest Tesla discovery.

"Just what is your new invention?" I asked. "I have accomplished what mechanical engineers have been dreaming about ever since the invention of steam power," replied Dr. Tesla. "That is the perfect rotary engine. It happens that I have also produced an engine which will give at least twenty-five times as much power to a pound of weight as the lightest weight engine of any kind that has yet been produced. "In doing this I have made use of two properties which have always been known to be possessed by all fluids, but which have not heretofore been utilized. These properties are adhesion and viscosity.

"Put a drop of water on a metal plate. The drop will roll off, but a certain amount of the water will remain on the plate until it evaporates or is removed by some absorptive means. The metal does not absorb any of the water, but the water adheres to it. "The drop of water may change its shape, but until its particles are separated by some external power it remains intact. This tendency of all fluids to resist molecular separation is viscosity. It is especially noticeable in the heavier oils. "It is these properties of adhesion and viscosity that cause the 'skin friction' that impedes a ship in its progress through the water or an airplane in going through the air. All fluids have these qualities--and you must keep in mind that air is a fluid, all gases are fluids, steam is fluid. Every known means of transmitting or developing mechanical power is through a fluid medium.

"Now, suppose we make this metal plate that I have spoken of circular in shape and mount it at its center on a shaft so that it can be revolved. Apply power to rotate the shaft and what happens? Why, whatever fluid the disk happens to be revolving in is agitated and dragged along in the direction of rotation, because the fluid tends to adhere to the disk and the viscosity causes the motion given to the adhering particles of the fluid to be transmitted to the whole mass. Here, I can show you better than tell you."

Dr. Tesla led the way into an adjoining room. On a desk was a small electric motor and mounted on the shaft were half a dozen flat disks, separated by perhaps a sixteenth of an inch from one another, each disk being less than that in thickness. He turned a switch and the motor began to buzz. A wave of cool air was

immediately felt. "There we have a disk, or rather a series of disks, revolving in a fluid--the air," said the inventor. "You need no proof to tell you that the air is being agitated and propelled violently. If you will hold your hand over the center of these disks--you see the centers have been cut away--you will feel the suction as air is drawn in to be expelled from the peripheries of the disks. "Now, suppose these revolving disks were enclosed in an air tight case, so constructed that the air could enter only at one point and be expelled only at another--what would we have?" "You'd have an air pump," I suggested. "Exactly--an air pump or blower," said Dr. Tesla. "There is one now in operation delivering ten thousand cubic feet of air a minute. "Now, come over here."...

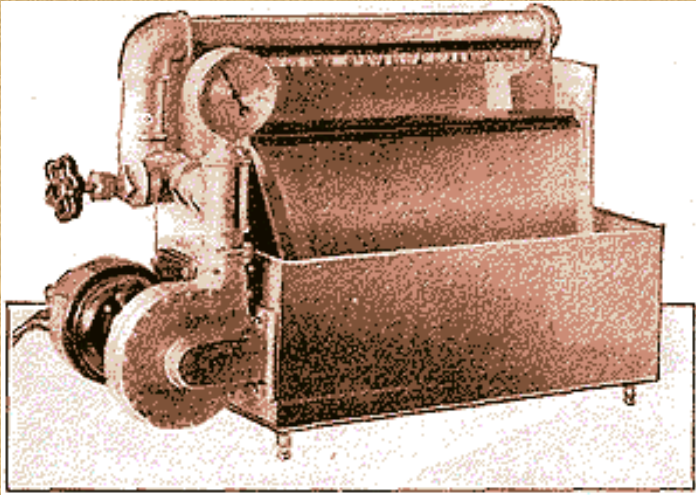

...He stepped across the hall and into another room, where three or four draughts men were at work and various mechanical and electrical contrivances were scattered about. At one side of the room was what appeared to be a zinc or aluminum tank, divided into two sections, one above the other, while a pipe that ran along the wall above the upper division of the tank was connected with a little aluminum case about the size and shape of a small alarm clock. A tiny electric motor was attached to a shaft that protruded from one side of the aluminum case. The lower division of the tank was filled with water. "Inside of this aluminum case are several disks mounted on a shaft and immersed in a fluid, water," said Dr. Tesla. "From this lower

tank the water has free access to the case enclosing the disks. This pipe leads from the periphery of the case. I turn the current on, the motor turns the disks and as I open this valve in the pipe the water flows."...

He turned the valve and the water certainly did flow. Instantly a stream that would have filled a barrel in a very few minutes began to run out of the pipe into the upper part of the tank and thence into the lower tank. "This is only a toy," said Dr. Tesla. "There are only half a dozen disks--'runners,' I call them--each less than three inches in diameter, inside of that case. They are just like the disks you saw on the first motor--no vanes, blades or attachments of any kind. Just perfectly smooth, flat disks revolving in their own planes and pumping water because of the viscosity and adhesion of the fluid. One such pump now in operation, with eight disks, eighteen inches in diameter, pumps four thousand gallons a minute to a height of 360 feet." We went back into the big, well lighted office. I was beginning to grasp the new Tesla principle. "Suppose now we reversed the operation," continued the inventor. "You have seen the disks acting as a pump.

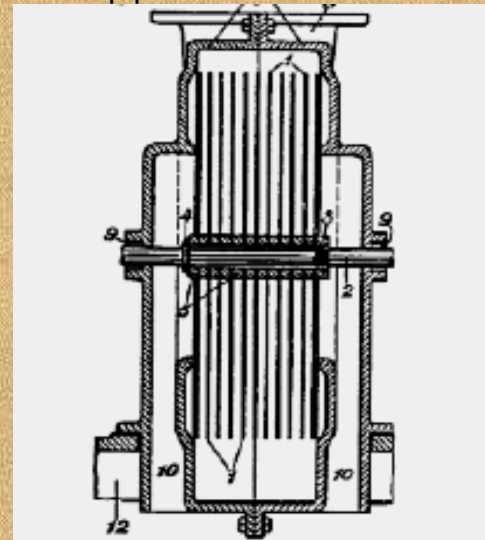

Suppose we had water, or air under pressure, or steam under pressure, or gas under pressure, and let it run into the case in which the disks are contained--what would happen?"...

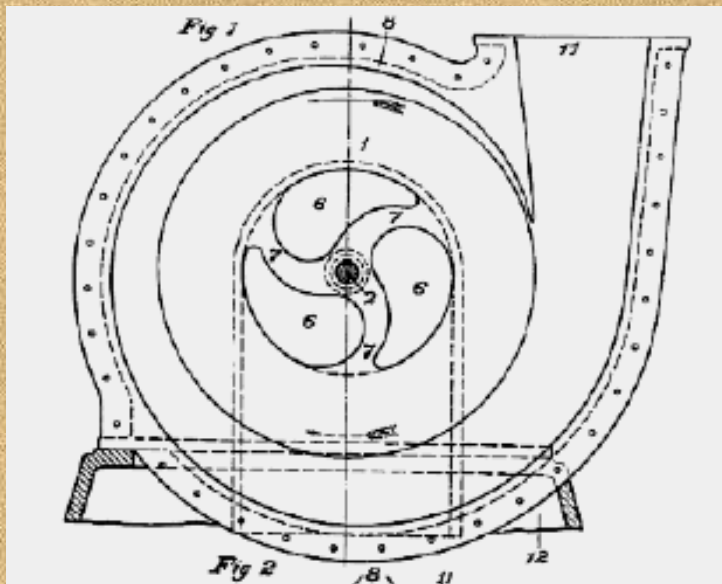

"The disks would revolve and any machinery attached to the shaft would be operated--you would convert the pump into an engine," I suggested. "That is exactly what would happen--what does happen," replied Dr. Tesla. "It is an engine that does all that engineers have ever dreamed of an engine doing, and more. Down at the Waterside power station of the New York Edison Company, through their courtesy, I have had a number of such engines in operation. In one of them the disks are only nine inches in diameter and the whole working part is two inches thick. With steam as the propulsive fluid it develops 110-horse power, and could do twice as much." "You have got what Professor Langley was trying to evolve for his flying machine--an engine that will give a horse power for a

pound of weight," I suggested...

Ten Horse Power to the Pound !

"I have got more than that," replied Dr. Tesla. "I have an engine that will give ten horse power to the pound of weight. That is twenty-five times as powerful as the lightest weight engine in use today. The lightest gas engine used on airplanes weighs two and one-half pounds to the horse power. With two and one-half pounds of weight I can develop twenty-five horse power."

"That means the solution of the problem of flying," I suggested. "Yes, and many more," was the reply. "The applications of this principle, both for imparting power to fluids, as in pumps, and for deriving power from fluids, as in turbine, are boundless. It costs almost nothing to make, there is nothing about it to get out of order, it is reversible--simply have two ports for the gas or steam, to enter by, one on each side, and let it into one side or other.

There are no blades or vanes to get out of order--the steam turbine is a delicate thing." I remembered the bushels of broken blades that were gathered out of the turbine casings of the first turbine equipped steamship to cross the ocean, and realized the importance of this phase of the new engine.

"Then, too," Dr. Tesla went on, "there are no delicate adjustments to be made. The distance between the disks is not a matter of microscopic accuracy and there is no necessity for minute clearances between the disks and the case. All one needs is some disks mounted on a shaft, spaced a little distance apart and cased so that a fluid can enter at one point and go out at another. If the fluid enters at the center and goes out at the periphery it is a pump.

If it enters at the periphery and goes out at the center it is a motor. "Coupling these engines in series, one can do away with gearing in machinery. Factories can be equipped without shafting. The motor is especially adapted to automobiles, for it will run on gas explosions as well as on steam. The gas or steam can be let into a dozen ports all around the rim of the case if desired. It is possible to run it as a gas engine with a continuous flow of gas, gasoline and air being mixed and the continuous combustion causing expansion and pressure to operate the motor.

The expansive power of steam, as well as its propulsive power, can be utilized as in a turbine or a reciprocating engine. By permitting the propelling fluid to move along the lines of least resistance a considerably larger proportion of the available power is utilized. "As an air compressor it is highly efficient. There is a large engine of this type now in practical operation as an air compressor and giving remarkable service. Refrigeration on a scale hitherto never attempted will be practical, through the use of this engine in compressing air, and the manufacture of liquid air commercially is now entirely feasible. "With a thousand horse power engine, weighing only one hundred pounds, imagine the possibilities in automobiles, locomotives and steamships. In the space now occupied by the engines of the Lusitanian twenty-five times her 80,000 horse power could be developed, were it possible to provide boiler capacity sufficient to furnish the necessary steam." "And it makes the airplane practical," I suggested.

"Not the airplane, the flying machine," responded Dr. Tesla. "Now you have struck the point in which I am most deeply interested--the object toward which I have been devoting my energies for more than twenty years--the dream of my life. It was in seeking the means of making the perfect flying machine that I developed this engine.

"Twenty years ago I believed that I would be the first man to fly; that I was on the track of accomplishing what no one else was anywhere near reaching. I was working entirely in electricity then and did not realize that the gasoline engine was approaching a perfection that was going to make the airplane feasible. There is nothing new about the airplane but its engine, you know. "What I was working on twenty years ago was the wireless transmission of electric power. My idea was a flying machine propelled by an electric motor, with power supplied from stations on the earth. I have not accomplished this as yet, but am confident that I will in time. "When I found that I had been anticipated as to the flying machine, by men working in a different field I began to study the problem from other angles, to regard it as a mechanical rather than an electrical problem. I felt certain there must be some means of obtaining power that was better than any now in use, and by vigorous use of my gray matter for a number of years I grasped the possibilities of the principle of the viscosity and adhesion of fluids and conceived the mechanism of my engine.

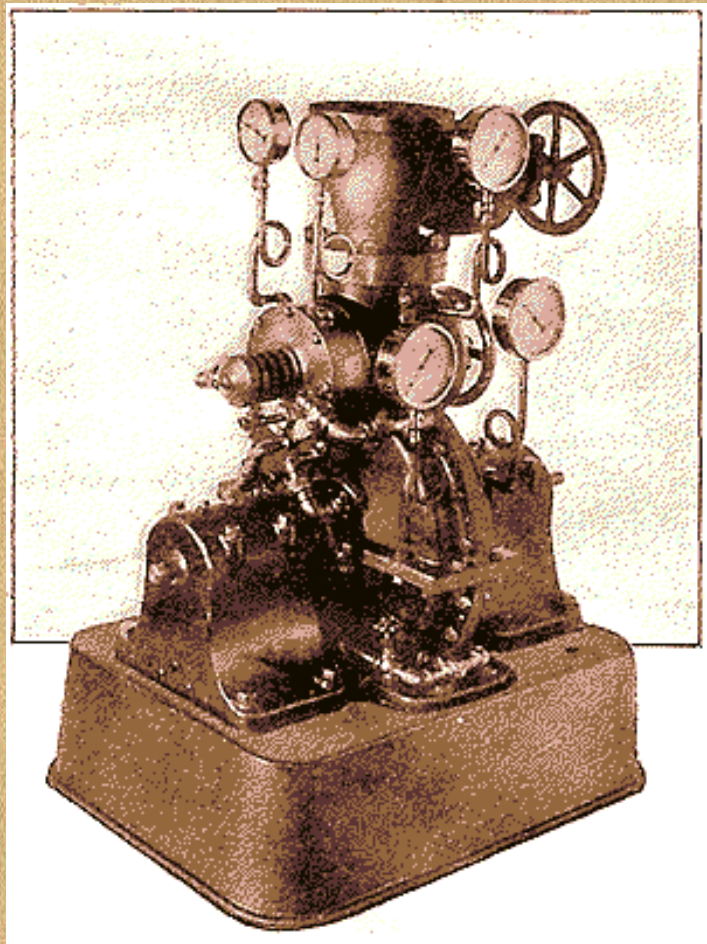

Now that I have it, my next step will be the perfect flying machine." "An airplane driven by your engine?" I asked. "Not at all," said Dr. Tesla. "The airplane is fatally defective. It is merely a toy--a sporting plaything. It can never become commercially practical. It has fatal defects. One is the fact that when it encounters a downward current of air it is helpless. The 'hole in the air' of which aviators speak is simply a downward current, and unless the airplane is high enough above the earth to move laterally but can do nothing but fall. "There is no way of detecting these downward currents, no way of avoiding them, and therefore the airplane must always be subject to chance and its operator to the risk of fatal accident. Sportsmen will always take these chances, but as a business proposition the risk is too great.

"The flying machine of the future--my flying machine--will be heavier than air, but it will not be an airplane. It will have no wings. It will be substantial, solid, stable. You cannot have a stable airplane. The gyroscope can never be successfully applied to the airplane, for it would give a stability that would result in the machine being torn to pieces by the wind, just as the unprotected airplane on the ground is torn to pieces by a high wind. "My flying machine will have neither wings nor propellers. You might see it on the ground and you would never guess that it was a flying machine. Yet it will be able to move at will through the air in any direction with perfect safety, higher speeds than have yet been reached, regardless of weather and oblivious of 'holes in the air' or downward currents. It will ascend in such currents if desired. It can remain absolutely stationary in the air even in a wind for great length of time. Its lifting power will not depend upon any such delicate devices as the bird has to employ, but upon positive mechanical action."

"You will get stability through gyroscopes?" I asked. "Through gyroscopic action of my engine, assisted by some devices I am not yet prepared to talk about," he replied. "Powerful air currents that may be deflected at will, if produced by engines and compressors sufficiently light and powerful, might lift a heavy body off the ground and propel it through the air," I ventured, wondering if I had grasped the inventor's secret.

Dr. Tesla smiled an inscrutable smile. "All I have to say on that point is that my airship will have neither gas bag, wings nor propellers," he said. "It is the child of my dreams, the product of years of intense and painful toil and research. I am not going to talk about it any further. But whatever my airship may be, here at least is an engine that will do things that no other engine ever has done, and that is something tangible."

The Tesla Pump

Looking out over the city from the windows of his office, on the twentieth floor of the Metropolitan Tower, his face lit up as he told of his life dream and its approaching realization, and the listener's fancy could almost see the air full of strange flying craft, while huge steamships propelled at unheard of speeds plough the waters of the North River, automobiles climbed the very face of the Palisades, locomotives of incredible power whisked wheeled palaces many miles a minute and all the discomforts of summer heat vanished as marvelous refrigerating plants reduced the temperature of the whole city to a comfortable maximum, for these were only a few of the suggestions of the limitless possibilities of the latest Tesla discovery.

"Just what is your new invention?" I asked. "I have accomplished what mechanical engineers have been dreaming about ever since the invention of steam power," replied Dr. Tesla. "That is the perfect rotary engine. It happens that I have also produced an engine which will give at least twenty-five times as much power to a pound of weight as the lightest weight engine of any kind that has yet been produced. "In doing this I have made use of two properties which have always been known to be possessed by all fluids, but which have not heretofore been utilized. These properties are adhesion and viscosity.

"Put a drop of water on a metal plate. The drop will roll off, but a certain amount of the water will remain on the plate until it evaporates or is removed by some absorptive means. The metal does not absorb any of the water, but the water adheres to it. "The drop of water may change its shape, but until its particles are separated by some external power it remains intact. This tendency of all fluids to resist molecular separation is viscosity. It is especially noticeable in the heavier oils. "It is these properties of adhesion and viscosity that cause the 'skin friction' that impedes a ship in its progress through the water or an airplane in going through the air. All fluids have these qualities--and you must keep in mind that air is a fluid, all gases are fluids, steam is fluid. Every known means of transmitting or developing mechanical power is through a fluid medium.

"Now, suppose we make this metal plate that I have spoken of circular in shape and mount it at its center on a shaft so that it can be revolved. Apply power to rotate the shaft and what happens? Why, whatever fluid the disk happens to be revolving in is agitated and dragged along in the direction of rotation, because the fluid tends to adhere to the disk and the viscosity causes the motion given to the adhering particles of the fluid to be transmitted to the whole mass. Here, I can show you better than tell you." Dr. Tesla led the way into an adjoining room.

On a desk was a small electric motor and mounted on the shaft were half a dozen flat disks, separated by perhaps a sixteenth of an inch from one another, each disk being less than that in thickness. He turned a switch and the motor began to buzz. A wave of cool air was immediately felt. "There we have a disk, or rather a series of disks, revolving in a fluid--the air," said the inventor. "You need no proof to tell you that the air is being agitated and propelled violently. If you will hold your hand over the center of these disks--you see the centers have been cut away--you will feel the suction as air is drawn in to be expelled from the peripheries of the disks. "Now, suppose these revolving disks were enclosed in an air tight case, so constructed that the air could enter only at one point and be expelled only at another--what would we have?" "You'd have an air pump," I suggested. "Exactly--an air pump or blower," said Dr. Tesla. "There is one now in operation delivering ten thousand cubic feet of air a minute. "Now, come over here."

He stepped across the hall and into another room, where three or four draughts men were at work and various mechanical and electrical contrivances were scattered about. At one side of the room was what appeared to be a zinc or aluminum tank, divided into two sections, one above the other, while a pipe that ran along the wall above the upper division of the tank was connected with a little aluminum case about the size and shape of a small alarm clock. A tiny electric motor was attached to a shaft that protruded from one side of the aluminum case. The lower division of the tank was filled with water. "Inside of this aluminum case are several disks mounted on a shaft and immersed in a fluid, water," said Dr. Tesla. "From this lower tank the water has free access to the case enclosing the disks. This pipe leads from the periphery of the case. I turn the current on, the motor turns the disks and as I open this valve in the pipe the water flows."

He turned the valve and the water certainly did flow. Instantly a stream that would have filled a barrel in a very few minutes began to run out of the pipe into the upper part of the tank and thence into the lower tank. "This is only a toy," said Dr. Tesla. "There are only half a dozen disks--'runners,' I call them--each less than three inches in diameter, inside of that case. They are just like the disks you saw on the first motor--no vanes, blades or attachments of any kind. Just perfectly smooth, flat disks revolving in their own planes and pumping water because of the viscosity and adhesion of the fluid. One such pump now in operation, with eight disks, eighteen inches in diameter, pumps four thousand gallons a minute to a height of 360 feet." We went back into the big, well lighted office. I was beginning to grasp the new Tesla principle...

To Go to "PART II" and learn more about the Tesla Turbine And Pump, click "NEXT"

NEXT

Information and resources: TESLA PATENTS

- [1921 Patent](#)
- [Fluid Propulsion Patent](#)
- [Original 1911 Turbine & Pump Patent](#)
- [Improved Method For the Production of High Vacuum - patent](#)

The Tesla Turbine "Yahoo Groups" List:

this list has grown substantially since its initial creation in 1999. The list is used to keep members informed of important updates, new ideas on turbine construction, and for a general forum and outlet on new and innovative concepts in the construction of the Tesla Turbine. The list is moderated by founder and creator of International Turbine And Power, LLC - Mr. Frank Germano. There are at any time approximately 1000 interested individuals on this list. If you would like to join this exciting Tesla Turbine List, use the link(s) below and follow the instructions.

● Click below, to subscribe...then follow the instructions. You will receive a confirmation email, from "Yahoo Groups" that you MUST reply to in order to join the group. Use the email address that you wish the confirmation email to be sent to.

Subscribe to TheTeslaTurbineList

Powered by groups.yahoo.com

Compliments & Acknowledgements: : Gary Peterson, "[Twenty First Century Books](#)"...if you are interested in learning more about the Tesla bladeless boundary disk turbine, or the Tesla Pump, check out Gary's web site. Besides carrying a complete listing of excellent books pertaining to Nikola Tesla (honestly: it's probably THE most comprehensive collection of Nikola Tesla books, articles and information We've ever seen...!), he also has written the book , "The Tesla Bladeless Turbine and Related Turbo Machinery", which goes into great detail and depth, on the turbine/pump itself. The web site definitely is worth the time to check out...it's a pretty large site. Great info !

Three Books I highly recommend:

"TESLA'S ENGINE...A NEW DIMENSION FOR POWER" by Jeffery Hayes...highly recommended!

Tesla's Engine: An New Dimension for Power

Product Type: Book

Authors: Jeffery A. Hayes

Publisher: Tesla Engine Builders Assn

Release Date: August, 1994

List Price: \$19.95

Our Price: **\$19.95**



The Tesla Disc Turbine

by W. M. J. Cairns

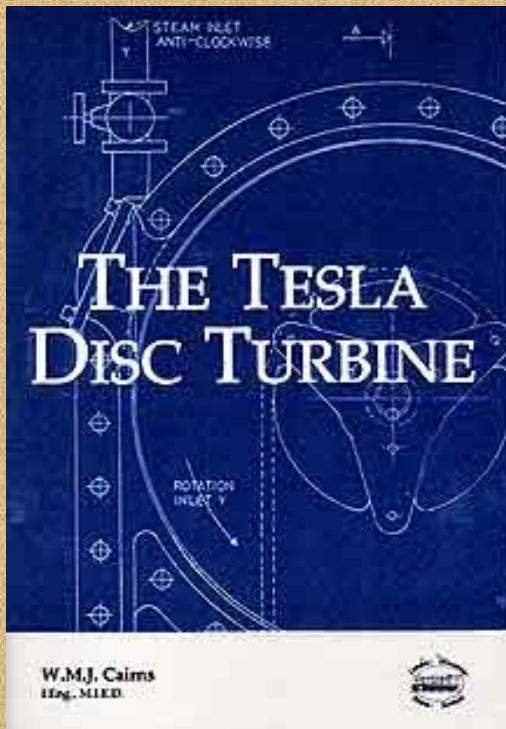

"This book describes the concept of the Disc Turbine as originally patented by Nicola Tesla, and provides concept designs for modern versions of the engine, incorporating the Disc Turbine as a power unit for applications in Automobiles and Light Aircraft, and also give descriptions of the original Turbines and the prototype machines. It also provides designs for other machines operating on the principle of a disc turbine: an Air Compressor, an Air Motor, and a Vacuum Exhauster. The facility of the principle to operate in either a clockwise or anti-clockwise direction of rotation, in a single machine, using only a two-way valve, is described, and applications where this feature can be applied to advantage are suggested.

Data is given on the performances attained by the original engines, together with stress and performance information. Finally, we give a design for a modernized version of the original turbine, to one half scale, complete with working drawings and manufacturing instructions to enable the model or experimental engineer to construct a fully operational engine, using such tools and equipment as are usually available to model makers.

It should be apparent that this dry foreword written by the author sounds like the abstract of a paper published in a professional engineering journal. That's because the author IS an engineer who has a number of published papers. Cairns is no novice. He knows what he's talking about. Chapters include: Tesla's original machine * The Disc Turbine Operating Principle * The first experimental Turbine * The 9.75 in. Disc Prototype Turbine * Larger Turbines to 60 in. disc diameter * Future developments * Other Rotary Engines * The Automotive Disc Turbine * Air Compressor, Vacuum Pump, Air Motor, Light Aircraft Engines * The Dual Direction Facility * Stresses in the discs and performance calculations * Building a model Disc Turbine * Drawings for a model Disc Turbine* Since this is a 36 page "booklet"

each "chapter" is necessarily short. But what you DO get is loaded with valuable information. Remember this is written by an engineer who is interested in getting results. The last nine pages are dedicated to the model with six pages of detailed, dimensioned drawings. The model described is approximately one half the size of the original Tesla unit, but uses present-day materials and techniques... Required machine tools are a lathe, with a 3.5" centre height, ideally with a milling attachment, and circular table, a bench drill, micrometer or vernier, and conventional hand tools (metric dimensions are used)

From the testing section: "Run for no more than two minutes, stop, check the housing temperature. If cool to slightly warm, re-open the valve and continue running. At around 1.75 bar and 1.5 cfm, the turbine will attain a shaft speed of 20,000 R.P.M. At all times ensure a supply of oil to the bearings, and continually monitor the housing temperature. It should be noted that the prototype attained a speed of approximately 50,000 R.P.M. under no-load conditions; hence it is advised that a brake or dynamometer be provided on the shaft."

["THE TESLA BLADELESS TURBINE AND RELATED TURBO MACHINERY"](#) by Gary L. Peterson...(Awesome!!!) If you have any interest in the Tesla Turbine - get this book !

Note: the question that I love the most, is - "so...does a Tesla turbine really work?" I would have hoped, that for the brighter among the readers of this page, that you would have gathered that the Tesla turbine not only "worked"; it worked amazingly well! Tesla not only had documentation from his own staff, and his own people...he had outside engineering firms confirming the figures. Many turbines were built and installed by Tesla (see "Wizard" by Mark Siefer), and numerous magazine and newspapers documented his success. My company - International Turbine And Power, LLC, was literally *built* because of this technology. The bladeless turbine, conceived by Tesla, is a reality. All that awaits is further investor funding to bring it to the commercial market.

**Frank D Germano, Frank@Germano.com
Founder and President,
International Turbine And Power
931 Rumsey Avenue, PO Box 550
Cody, Wyoming 82414**

[INDEX TO ENTIRE SITE](#)

NIKOLA TESLA:

**[\[Home\]](#)[\[Tesla Technology, Today\]](#)[\[Nikola Tesla\]](#)
[\[The Tesla Engine\]](#)[\[Tesla Tunguska; Free Energy\]](#)
[\[The Tesla Bladeless Boundary Disk Turbine\]](#)
[\[Tesla's "Black Box"\]](#)[\[Greatest Hack of All Time?\]](#)
[\[the Lost Tesla Inventions\]](#)[\[A Machine To End War\]](#)**

[\[the Wonderworld to be Created by Electricity\]](#)

[\[the Telsa & Schauberger Bookstore \]](#)

VIKTOR SCHAUBERGER:

[\[Water Power - Vortex Theories-\]](#)[\[Water Power II\]](#)

[\[Viktor Schauberger -1-\]](#)[\[Viktor Schauberger -2-\]](#)[\[Viktor Schauberger -3-\]](#)[\[Viktor Schauberger -4-\]](#)

[\[Christian Links\]](#)



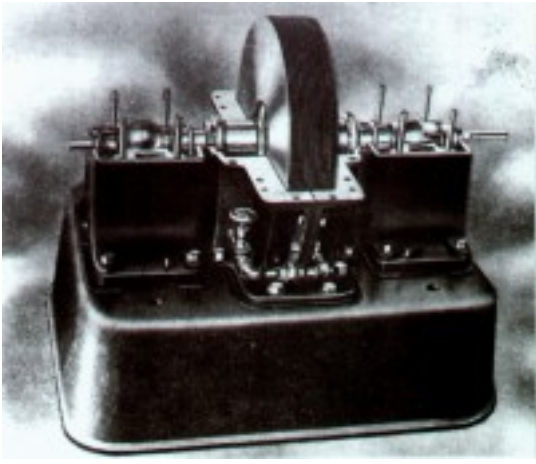

The Lost Inventions of Nikola Tesla

"Short-winded" bio: TESLA, Nikola (1856-1943), electrical inventor. Tesla was famous at the turn of the century for inventing the alternating current system still in use today. But his later inventions, documented in some 30 U.S. patents between 1890 and 1921, have never been utilized as Tesla intended despite their obvious potential for advancing in fundamental ways the technology of modern civilization. Among these lost inventions: the disk-turbine rotary engine, the Tesla coil, electric energy magnifier, high-frequency lighting systems, the magnifying transmitter, wireless power, and the free-energy receiver. Born Yugoslavia, 1856. Educated at the polytechnic school at Graz and at University of Prague. Worked as telephone engineer in Prague and Paris. Conceived new type of electric motor having no commutator, as direct current motors have, but works on principle of rotating magnetic field produced by poly phase alternating currents. Constructed prototype. Found nobody interested in Europe. Emigrated to U.S. (1884). Worked briefly and unhappily with Thomas Edison.

Established own lab and obtained patents on poly phase motors, dynamos, transformers for a complete alternating current power system. Formed alliance with George Westinghouse, who bought poly phase patents for \$1 million plus royalty. With Westinghouse, engaged in struggle against Edison to convince public of efficiency and safety of AC over DC, and succeeded in getting Alternating Current accepted as the electric power system worldwide.

Also with Westinghouse, lit the Chicago World's Fair, built Niagara Falls hydropower plant, and installed AC - Alternating Current - systems at Colorado silver mines, and other industries. By turn of the century was lifted to celebrity status comparable to Edison's as media promoted him along with the expanding electric power industry. Experimenting independently in Manhattan lab, developed and patented electric devices based on superior capabilities of high-potential, high-frequency currents: Tesla coil, radio, high-frequency lighting, x-rays, electrotherapy. Suffered lab fire. Rebuilt, and continued. Moved lab to Colorado Springs for about one year (1899). Built huge magnifying transmitter. Experimented with wireless power, radio, and earth resonance. Studied lightning. Created lightning. Returned to New York. With encouragement of financier J.P. Morgan, promoted a World System of radio broadcasting utilizing magnifying transmitters. Built huge tower for magnifying transmitter at Wardenclyffe, Long Island as first station in World System. Received enough from Morgan to bring station within sight of completion, then funds cut off, project collapsed.

Continued to invent into the 1920's, but flow of patents meager compared to earlier torrent, which amounted to some 700 patents worldwide. High-frequency inventions ignored by established technology, as were disk turbine, free energy receiver, and other inventions. Shut out by media except for birthday press conferences. At these conferences, predicted microwaves, TV, beam technologies, cosmic-ray motor, interplanetary communications, and wave-interference devices that since have been named the Tesla howitzer and the Tesla shield. In the 1930's, he was involved in wireless power projects in Quebec. Last birthday media appearance in 1940.

Died privately and peacefully at 87 in New York hotel room from no apparent cause in particular. Personal papers, including copious lab notes, impounded by U.S. Government, surfaced many years later at the "Tesla Museum", in Belgrade, Yugoslavia. Of these notes, only a fragment, "Colorado Springs Notes", has been published by the Museum.

the inventions:

1. Disk-Turbine Rotary Engine

Tesla called it a powerhouse in a hat. One version developed 110 h.p. at 5000 RPM and was less than ten inches in diameter. Tesla believed larger turbines could achieve 1000 HP. The disk-turbine rotary engine runs vibration free. It is cheap to manufacture because nothing but the rotor bearings needs to be fitted to close tolerances. It requires little maintenance. If necessary, the rotor can be replaced with ease. The turbine can run on steam, compressed air, gasoline, or oil.

How it works

Unlike conventional turbines that use blades or buckets to catch the flow, Tesla's uses a set of rigid metal disks that, instead of battling the propelling stream at steep angles, runs with smooth efficiency in parallel with the flow. What drives the disks is a peculiar adhesion that exists between the surface of a body and any moving fluid. This adhesion, is, in Tesla's words, caused by the shock of the fluid against the asperities of the solid substance (simple resistance) and from internal forces opposing molecular separation (a sticking phenomenon).

The propellant enters the intake and is directed through a nozzle onto the disks at their perimeter. It travels over the spinning disks in a spiral fashion, exiting at the disks' central openings and is exhausted from the casing. Tesla notes in his patent that, in an engine driven by a fluid, changes in the velocity and direction of movement of the fluid should be as gradual as possible. This, he observes, is not the case, though, in existing engines where sudden changes, shocks, and vibrations are unavoidable. The use of pistons, paddles, vanes and blades, notes Tesla, necessarily introduces numerous defects and limitations and adds to the complication, cost of production, and maintenance of the machines.

We who are stuck with the piston engine know this all too well. The Tesla turbine is vibration-free because the propelling fluid moves in natural paths or stream lines of least resistance, free from constraint and disturbance. Conducting the propellant through the intake valve on the other side easily reverses the turbine.

Internal combustion

A hollow casting is bolted to the top of the turbine for the internal combustion mode. A glow plug or spark plug screws into the top of this chamber. Sticking out of the sides are the intake valves. Interesting thing about these valves, there are no moving parts. They work on a fluidic principle. The Tesla turbines' only moving part is its rotor. Imagine, a powerful internal combustion engine with only one moving part.

Fluidics

The fluidic valve, which Tesla calls a valvular conduit, allows easy flow in one direction but in the other the flow gets hung up in dead-end chambers (buckets) where it gets spun around 360 degrees, thus forming eddies, or countercurrents that stop the flow as surely as if a mechanical valve were moved into the shut position. The spinning rotor creates plenty of suction to pull fuel and air into the combustion chamber. Tesla notes that after a short lapse of time the chamber becomes heated to such a degree that the ignition device may be shut off without disturbing the established regime. In other words; it diesels. The disk-turbine motor principle in reverse becomes a very efficient pump. (Tesla's Patent No. 1,061,142)

Fluid drive

The disk turbine principle is employed in the speedometer, which presents the problem of having to turn the rotary motion of a vehicles wheels to angular motion in order to push a spring-loaded indicator needle over a short arc. Tesla's solution: the speedometer cable connects to a disk which spins in interface with a second disk, imparting spin to the fluid in between and, hence, to the second disk which moves the needle. Interface two disks of different sizes in a fluid medium and any desired ratio between speeds of rotation may be obtained by proper selection of the diameters of the disks, observes Tesla in his patent, thus anticipating in 1911 the fluid-drive automatic transmission.

Tesla First worked on his turbine early in his career, believing it would be a good prime mover for his alternating-current dynamos, far superior to the reciprocal steam engines that were the workhorses of that era. But he did not get down to perfecting and patenting it until after the collapse of his global broadcasting scheme (1909). By this time the internal-combustion piston engine was firmly rooted in Western power mechanics. Tesla referred to organized opposition to his attempts to introduce the superior engine, and so have others who have made the attempt since. But Tesla still saw a glorious future for his turbine. To his friend, Yale engineering professor Charles Scott, Tesla predicted, "My turbine will scrap all the heat engines in the world." Replied Scott, "That would make quite a pile of scrap."

2. Spark-Gap Oscillator:

Tesla was central in establishing the 60 cycle alternating current power system still in use today. Yet he suspected that the more striking phenomena resided in the higher frequencies of electric vibration. To reach these heights, he first tried dynamos spun at higher speeds and having a greater number of poles than any that had existed before. One having as an armature a flat, radially grooved copper disk achieved 30,000 cycles, but Tesla wanted to go into the millions of cycles.

It occurred to him that this vibratory capability was to be found in the capacitor. With a capacitor circuit, the spark-gap oscillator, he did indeed achieve the higher frequencies, and he did so by non mechanical means. The circuit was promising enough for him to patent it as A Method of and Apparatus for Electrical Conversion and Distribution, for Tesla saw in it the possibility of a whole new system of electric lighting by means of high frequencies. Though it was quickly succeeded by the Tesla

coil and is not numbered among the more famous of the lost inventions, the spark-gap oscillator is pivotal for Tesla as the invention that launched him into his career in high frequencies.

How it works

The capacitor. There are only a few basic building blocks of electrical circuitry. The capacitor is one of them. Tesla didn't invent it, it had been around for some time, arguably for millennia, but he did improve upon it in three of his patents. Also called condenser, the common capacitor is just a sandwich of conductive and nonconductive layers that serves the purpose of storing electrical charge. The simplest capacitor has just two conductive sheets separated by a single sheet of insulation. In the capacitor shown, the conductive elements are two metal plates.

The insulation between them is oil. In the official vocabulary, the plates are indeed called plates and the insulative layer (oil, glass, mica, or whatever) is called the dielectric. Connect the two terminals of a capacitor into a circuit where there is plus-minus electrical potential, and charge builds on the plates, positive on one, negative on the other. Let this charge build for a while, and then connect the two plates through some resistance, a coil, say, and the capacitor discharges very suddenly. Tesla said, The explosion of dynamite is only the breath of a consumptive compared with its discharge. He went on to say that the capacitor is the means of producing the strongest current, the highest electrical pressure, the greatest commotion in the medium.

The capacitor's discharge is not necessarily a single event. If it discharges into a suitable resistance, there is a rush of current outward, then back again, as if it were bouncing off the resistance, then out, and back and so forth until it peters out. The discharge is oscillatory, a vibration. The vibration can be sustained by recharging the capacitor at appropriate intervals. When Tesla talks of the capacitor's discharge causing commotion in the medium, he means a vibration or mix of vibrations. The character of this vibration is determined in part by the capacity of the capacitor, that is, how much charge it will hold. This is a function of its size, the distance between plates, and the composition of the dielectric. Upon discharge there would be, typically, a fundamental vibration, some harmonics, and perhaps other commotion, maybe musical, maybe not. Additional circuitry can tame the vibration to a pure tone.

The medium

When Tesla speaks of commotion in the medium, what is the medium? In Tesla's time it was an article of faith that there existed a unified field that permeated all being called the ether. The ether as the electric medium still is an article of faith in some circles, but in official science its existence is presumed to have been disproved in the laboratory. Nevertheless, this conviction about an ether ran very deep, not only among scientists but among all thinkers, until only about forty-some years ago when particle theory, $E=MC^2$, and, finally Hiroshima firmly established the new faith. Tesla said the electron did not exist.

The materialistic concept of these little particles running through conductors is alien to Tesla electric theory. Here is the Quaker writer Rufus Jones on the ether in 1920: An intangible substance which we call ether - luminiferous (light-bearing) aether - fills all space, even the space occupied by visible objects, and this ether which is capable of amazing vibrations, billions of times a second, is set

vibrating at different velocities by different objects. These vibrations bombard the minute rods of the retina... It is responsible also for all the immensely varied phenomena of electricity, probably, too of cohesion and gravitation...

The dynamo and the other electrical mechanisms, which we have invented do not make or create electricity. They merely let it come through, showing itself now as light, now as heat, now again as motive power. But always it was there before, unnoted, merely potential, and yet a vast surrounding ocean of energy there behind, ready to break into active operation when the medium was at hand for it. Jones, who was not a scientist but a religious thinker and communicator, was making a point about the nearness of God's power and could do so by invoking the physics of his time. This would be difficult using the Einsteinian physics in fashion today, which W. Gordon Allen has called atheistic science.

Although the ether is intangible, it is assumed to have elastic properties, so that Tesla can say a circuit with a large capacity behaves as a slack spring, whereas one with a small capacity acts as a stiff spring vibrating more vigorously. This elastic character of the ether, which you experience palpably when you play with a pair of magnets, is due to the medium's lust for equilibrium. Distorted by electrical charge (or by magnetism or by the gravity of a material body), the ether seeks to restore a perfect balance between the polarities of positive-negative, plus/minus, yang/yin.

Voltage is the measure of ether strain or imbalance, called potential difference, or just potential. Balance is not restored from this strained condition in one swing-back. As we have seen with the capacitor, the disturbed electric medium, like a plucked guitar string, over-swings the centerline of equilibrium to one side, then to the other, again and again, and this we know as vibration. In this way of looking at nature, vibration is energy; energy is vibration. So you could say that the commotion in the medium caused by the capacitors discharge is energy itself.

Thus, you can speak of the capacitor as an energy magnifier. Even though a feeble potential may charge it, the sudden blast of the capacitor's release plucks the medium mightily. The capacitor is common in modern circuitry, but Tesla used it with much greater emphasis on its capability as an energy magnifier and on a scale almost unheard of today. It's difficult to find commercial capacitors that meet Tesla specifications. Builders of tesla coils and other high-voltage devices usually must construct their own capacitors. Fortunately, this can be done using readily available materials.

How it works

The spark gap: A simple way to discharge a capacitor is through a spark gap. The spark-gap oscillator is just a capacitor firing into a circuit load (lamps or whatever) through the spark gap. The opening between the spark-gap electrodes determines when the capacitor will fire. This setting is one determinant of the frequency of the circuit.

The others are capacity and the reactance, or bounce characteristics, of the load. The potential needed to bridge the gap is in the tens of thousands of volts. It takes a potential of about 20,000 volts to break down the resistance of just a quarter of an inch of air. The gap doesn't necessarily have to be air. Tesla has referred to a gap consisting of a film of insulation. A spark gap is a switching device, a semiconductor in fact. But the spark gap is problematic, particularly the common two-electrode air-gap

version. Heating and ionizing of the air cause irregularities in conduction and premature firing.

This arcing must be quenched. It can be to a great degree by using a series of small gaps instead of one larger one, or by using a rotary gap. Tesla also immersed the gap in flowing oil, used an air blowout, and even found that a magnetic field helps to quench. For the gap Tesla substituted high-speed rotary switches, which he called circuit controllers. One has a rotor that dips into a pool of mercury, and another uses mercury jets to make contact. You can operate a spark gap without a capacitor by connecting it directly to a source of sufficient voltage.

This is, of course, how our automotive spark plugs work, directly off the coil. (The capacitor in that circuit is used to juice the ignition coil primary.) The auto distributor, incidentally, is a rotary gap, pure Tesla. Early radio amateurs used spark-gap oscillators as transmitters. The capacitor was, more often than not, left out of the circuit, but with it the transmitter could create a greater commotion in the medium.

3. Tesla Coil

Tesla's best-known invention takes the spark-gap oscillator and uses it to vibrate vigorously a coil consisting of few turns of heavy conductor. Inside of this primary coil sits another secondary coil with hundreds of turns of slender wire. In the Tesla coil there is no iron core as in the conventional step-up transformer, and this air-core transformer differs radically in other ways. Recounting the birth of this invention, Tesla wrote, Each time the condenser was discharged the current would quiver in the primary wire and induce corresponding oscillations in the secondary. Thus, a transformer or induction coil on new principles was evolved Electrical effects of any desired character and of intensities undreamed of before are now easily producible by perfected apparatus of this kind. Elsewhere Tesla wrote, There is practically no limit to the power of an oscillator.

The conventional step-up transformer (short primary winding, long secondary on an iron core) boosts voltage at the expense of amperage. This is not true of Tesla's transformer. There is a real gain in power. Writing of the powerful coils he experimented with at his Colorado Springs lab, coils with outputs in excess of 12 million volts, Tesla wrote, It was a revelation to myself to find out that ... a single powerful streamer breaking out from a well insulated terminal may easily convey a current of several hundred amperes! The general impression is that the current in such a streamer is small.

How it works

A Tesla coil secondary has its own particular electrical character determined in part by the length of that slender coiled wire. Like a guitar string of a particular length, it wants to vibrate at a particular frequency. The secondary is inductively plucked by the primary coil. The primary circuit consists of a pulsating high-voltage source (a generator or conventional step-up transformer), a capacitor, a spark gap, and the primary coil itself. This circuit must be designed so that it vibrates at a frequency compatible with the frequency at which the secondary wants to vibrate.

The primary circuit's frequency is determined by the frequency and voltage of the source, the capacity of the capacitor, the setting of the spark gap, and the character of the primary coil, determined in part

by the length of its winding. Now when all these primary-circuit components are tuned to work in harmony with each other, and the circuit's resulting frequency is right for plucking the secondary in a compatible rhythmic manner, the secondary becomes at its terminal end maximally excited and develops huge electrical potentials, which if not put to work, boil off as a corona of bluish light or as sparks and streamers that jump to nearby conductors with crackling reports.

Unlike the conventional iron-core step-up transformer, whose core has the effect of damping vibrations, the secondary of the Tesla transformer is relatively free to swing unchecked. The pulsing from the primary coil has the effect of pushing a child in a swing. If it's done in a rhythmic manner at just the right moment at the end of a cycle, the swing will oscillate up to great heights. Similarly, with the right timing, the electrical vibration of the secondary can be made to swing up to tremendous amplitudes, voltages in the millions. This is the power of resonance.

Manmade earthquake

Tesla was fascinated with the power of resonance and experimented with it not only electrically but on the mechanical plane as well. In his Manhattan lab he built mechanical vibrators and tested their powers. One experiment got out of hand.

Tesla attached a powerful little vibrator driven by compressed air to a steel pillar. Leaving it there, he went about his business. Meanwhile, down the street, a violent quaking built up, shaking down plaster, bursting plumbing, cracking widows, and breaking heavy machinery off its anchorage. Tesla's vibrator had found the resonant frequency of a deep sandy layer of subsoil beneath his building, setting up an earthquake.

Soon Tesla's own building began to quake, and, just at the moment the police burst into the lab, Tesla was seen smashing the device with a sledgehammer, the only way he could promptly stop it. In a similar experiment, on an evening walk through the city, Tesla attached a battery-powered vibrator, described as being the size of an alarm clock, to the steel framework of a building under construction and, adjusting it to a suitable frequency, set the structure into resonant vibration. The structure shook, and so did the earth under his feet.

Later Tesla boasted that he could shake down the Empire State Building with such a device, and, as if this claim were not extravagant enough, he went on to state that a large-scale resonant vibration was capable of splitting the Earth in half. No details of Tesla's vibrators are available, but they probably resembled one of Tesla's reciprocating engines (such as Patent No. 511,916). These exploited the elasticity of gases, just as his electrical vibrators, like the Tesla coil, exploit the elasticity of the electric medium.

A new power system

Tesla invented his resonant transformer, as the Tesla coil is sometimes called, to power a new type of high-frequency lighting system, as his 1891 patent drawing shows. This was the first Tesla coil patent. There followed a series of other patents developing the device. All of these are for bipolar coils: both ends of the secondary are connected to the working circuit (usually lamps), as opposed to the mono

polar format favored by today's basement builders in which the top is connected to a ball or other terminal capacitor, the bottom to ground. The mono polar format emerges later in patents for radio and wireless power, including Tesla's magnifying transmitter.

The 1896 patent drawing shows an evolved bipolar coil using tandem chokes to store energy for sudden release into the capacitor, enabling the device to be powered by relatively modest inputs. Chokes are coils wound on iron cores. They store energy as magnetism. When the charging current is interrupted, the magnetic field collapses inducing current in the coils, which rushes in to charge the capacitors.

Superconductivity

Alternating currents can be sent over long distances with relatively low losses. This is why Tesla's early 60-cycle system triumphed over Edison's direct current. The high frequency, high-potential output of a Tesla coil can travel over relatively light conductors for vastly greater distances than conventional 60-cycle AC. Losses occur to some degree from corona discharge but hardly at all from ohmic resistance. This type of current also renders conductive materials that are normally nonconductive, rarefied gases, for example. You might say these currents make a medium superconductive.

Although super-magnetism is not in the picture because high-frequency vibrations would be severely damped by an electromagnet's iron core, it is revealing to reflect upon the unexploited superconductivity of Tesla energy these days when science is congratulating itself on new advances in the field. Prior to recent breakthroughs, superconductivity and super magnetism were low-temperature (cryogenic) phenomena, occurring when circuits were cooled down to near absolute zero. The new superconductivity at less drastically reduced temperatures developed out of the cryogenic work of the last twenty years, and this may be in debt to Tesla, who patented a similar idea way back in 1901.

Tesla's patent shows that the deep cooling of conductors with agents like liquid air results in an extraordinary magnification of the oscillation in the resonating circuit. Imagine the performance of a super cooled Tesla coil. No electrocution. Since we tend to associate high voltage with possibly fatal electric shock it may be puzzling to learn that the output of a well-tuned Tesla coil, though in the millions of volts, is harmless. This is customarily thought to be because the amperage is low (it's not) or it's explained in terms of something called the skin effect, which means that the current travels over you instead of through. But the real reason is a matter of human frequency response. Just as your ears cannot respond to vibrations over about 30,000 cycles, or the eyes to light vibrations at or above ultra violet, your nervous system cannot be shocked by frequencies over about 2,000 cycles.

Electrotherapy

Now that you know it's harmless, would you believe these currents are even good for you? Fact is that a whole branch of medicine was founded on the healing effects of certain Tesla coil frequencies. Tesla understood the therapeutic value of high-frequency vibrations. He never patented in the area but did announce his findings to the medical community, and a number of devices were patented and marketed by others.

Patients, by focusing certain frequencies on afflicted areas, or, in some cases, just sitting in the vicinity of vibrations from a device like the Lakhovsky Multi wave Oscillator, which produced a blend of specific frequencies, were said to have experienced relief from rheumatism and other painful conditions. It was even considered a cure for certain types of paralysis. Such radiation's increase the supply of blood to the area with a warming effect (diathermy). They enhance the oxygenation and nutritive value of the blood, increase various secretions, and accelerate the elimination of waste products in the blood. All this promotes healing. Electrotherapists even spoke of broadcasting vitamins to the body. Reversals of cancer tumor growths have been documented. Lakhovsky predicated science will discover, some day, not only the nature of microbes by the radiation they produce, but also a method of killing disease within the body by radiation.

Electrotherapy devices were sold directly to the public via ads in popular magazines and in the Sears catalogs. Self-treatment was widespread. This easy access to treatment of all sorts of conditions led to the eventual suppression of the technology by the medical establishment. Electrotherapy, however, is making a big comeback. In chiropractic and sports medicine, low-frequency AC and DC pulses are being used to kill pain and exercise muscles. High-frequency electrotherapy is coming back in alternative healing practices. There is an increasing appreciation of the electrical nature of biological functioning and that some electric vibrations in the environment are harmful while others are healing. Reprints of Lakhovsky's works are widely read. There is a growing conviction that cancer can be effectively treated with high-frequency therapies.

In his experimenting over an eight-year period, Tesla made no fewer than 50 types of oscillating coils. He experimented with lighting and other vacuum effects, including x-rays. He also experimented with novel shapes for the normally cylindrical coils, getting satisfying results from cone shapes and flat spirals. At Colorado Springs Tesla achieved phenomenally increased outputs by using a third coil resonantly tuned to the secondary. Observing the tremendous magnification this achieved, he gave much of his attention to integrating this extra coil, as he called it, into an evolved outsize tesla coil called the magnifying transmitter.

4. Magnifying Transmitters; Wireless Power

In 1893 Tesla told a meeting of the National Electric Light Association that he believed it practical to disturb, by means of powerful machines, the electrostatic conditions of the earth, and thus transmit intelligible signals, and, perhaps, power. He said, It could not require a great amount of energy to produce a disturbance perceptible at a great distance, or even all over the surface of the earth. The ultimate powerful machine for these tasks is Tesla's magnifying transmitter.

How it works

An extra coil gives the resonant boost of a Tesla coil secondary but has the advantage of being more independent in its movement. A secondary, being closely slaved to the primary, is inhibited somewhat by it, its oscillations slightly damped. The extra coil is able to swing more freely. Extra coils, writes Tesla, enable the obtainment of practically any EMF, the limits being so far remote that I would not hesitate to produce sparks of thousands of feet in this manner.

The engineering challenge of the magnifying transmitter, then, becomes one of containing and properly radiating its immense electrical activities, measured in the tens and even hundreds of thousands of horsepower, as Tesla put it. Containment and effective radiation of this power is the whole point of the design shown, for which Tesla applied for patent in 1902. The heavy primary is wound on top of the secondary at the base of the tower. The extra coil extends upward through a hooded connection to a conductive cylinder.

The antenna is a toroid, a donut-shaped geometry that allows for a maximum of surface area with a comparative minimum of electrical capacity. Since this is a high-frequency device, a relatively low capacity is desirable. To increase the area of the radiating surface, the outside of the toroid is covered with half-spherical metal plates. A subtlety of the design is that the conductive cylinder is of larger radius than the radius of curvature of these plates, since a tighter curve would allow escape of energy. The cylinder is polished to minimize losses through irregularities in the surface. At the center of the top surface sits a pointy plate that serves as a safety valve for overloads so the powerful discharge may dart out there and lose itself harmlessly in the air.

Tesla advises bringing the power up slowly and carefully so pressure does not build at some point below the antenna, in which case a ball of fire might break out and destroy the support or anything else in the way, an event that may take place with inconceivable violence. Current in the antenna could build to an incredible 4000 amperes.

A.C. / D.C.

Wireless power transmission via the magnifying transmitter was the ultimate development of the inventor who had earlier brought alternating-current power to the world with his poly phase system. The predecessor of A.C. was a direct-current system developed, manufactured, and marketed chiefly by Thomas Edison. Direct current was adequate for serving small areas but was unworkable for long distance transmission. By contrast, A.C. could be transmitted for long distances over lighter wires and its voltage could be stepped up for transmission and down for consumption by means of transformers. Tesla invented from scratch a new kind of motor (poly phase) that could utilize A.C., and he greatly evolved earlier concepts of dynamos to generate A.C. as well as transformers to step voltage up and down. Whereas Edison's D.C. would have been suitable for a society of small, autonomous communities, the evolving system of industrial rule wanted centralized power and needed A.C.'s long distance capability to serve huge sprawling populations.

George Westinghouse, an inventor (the air brake) who, like Edison, turned industrialist (having found that to profit from an invention one must undertake manufacturing and marketing as well) saw the promise in Tesla's poly phase inventions and formed an alliance with the young prodigy. Westinghouse paid Tesla one million dollars and contracted to pay a royalty of one dollar per horsepower for the poly phase inventions. Later Westinghouse was forced to renege on the royalty.

Together, Westinghouse and Tesla triumphed over Edison's D.C. system and installed the first A.C. power facilities, the most notable being the hydra plant at Niagara Falls. Tesla believed in hydropower. His ultimate energy-magnifying, wireless power system would have been hydro-based. The centralized A.C. electric power system we have today was forced into existence on a colossal scale by utility

magnates of that era, the most prominent being Samuel Insull, who became infamous in some circles for his massive bilking of the investing public and famous in others for hammering together the electric power complex now in place. This complex has developed into a federally protected monopoly with greater capital wealth than any other industry in the U. S. In the order of energy sources used, Tesla's hydropower has been left well behind the burning of fossil fuels, a process that dumps 24 million tons of pollutants into the nation's air supply each year.

Hydropower even runs way behind the nukes in kilowatt-hours produced. So went another Tesla dream. Tesla was a celebrity in his poly phase heyday, but today his celebrity is as an underground cult figure known for his radically progressive energy-magnifying, free-energy, and wireless power inventions, which, of course, have no place in the established system.

Power by wire

Prior to his wireless power inventions, Tesla patented in 1897 a high frequency system that transmitted power by wire. The system used previously unheard of levels of electric potential. He notes that at these voltages, conventional power would destroy the equipment, but that his system not only contains this energy but is harmless to handle while in use. This system is not a circuit in the usual sense but a single wire without return. It employs the familiar Tesla coil configurations at both sending and receiving ends. The primary circuit (power source, capacitor, spark gap) is represented in the drawing by the generator symbol. The secondary coil is a flat spiral. An advantage in this coil design is that the voltage adjacent to the primary, where arcing across could occur, is at zero and soars to high values as the coil spirals inward. The same patent also shows a cone-shaped secondary in which the primary is at the base of the cone, which is at zero potential.

Wireless power

The drawing for Tesla's wireless power patent looks like the earlier power-by-wire patent except now spherical antennas replace the transmission lines, which are dropped out of the picture almost as if they were redundant. The ball antenna is peculiarly Tesla, as is the toroid, and you wonder why nothing like them have appeared since. In this 1900 patent, wireless power is not represented as an earth-resonant system. Here Tesla talks about transmission through elevated strata. The patent contains much discussion of how rarefied gases in the upper atmosphere became quite conductive when there is applied many hundred thousand or millions of volts. Balloons are suggested to send the antennas aloft. Appreciate that Tesla in this patent has invented nothing less than the principles of radio.

Tesla recognizes only a quantitative difference between sending radio signals and broadcasting electric power. Both involve sending and receiving stations tuned to one another by means of tesla coil circuits. Tesla's wireless power would be the ultimate centralized electric system, a capitalist dream, but for the fact that the technology is too simple. Just raising an antenna, planting a ground, and connecting simple Tesla coil circuitry in between could achieve reception of power.

Although Tesla himself patented a couple of electric meters for high frequencies, it would be all too easy for consumers to tune in for free, just as many today bootleg pay TV signals using illicit

equipment far more sophisticated. It is no wonder, then, that the electric power establishment didn't welcome this invention. This was one problem. Another was that the established electric power system would have to be relegated to another great pile of scrap, and maybe the established system of political power as well.

Tesla's announced dream was to use hydra sources where available and through wireless power broadcast that energy around the planet, thus liberating the world from poverty. Such a scheme would not be readily embraced by powers that sustain their rule by keeping populations poor and weak. Centralized control of energy, as well as other resources, is, of course, believed to be essential to civilized rule, at least as far as thinking on that subject has progressed in this era. Moreover, no multinational political system was in existence, or is now for that matter, that could implement a technology of such global implications. Tesla was blind to such considerations.

His commitment, his overriding priority as a technological purist, was to take machine possibilities to their logical conclusions. Today, if wireless power were seriously proposed, there would no doubt be at least one political problem that would not have arisen in Tesla's time: resistance from environmentalists. What would an environmental impact report have to say about biologic hazards? A Navy submarine communication system that uses extremely low frequency (ELF) waves, down to below 10 cycles, has been challenged by environmentalists, as have microwave and 60 cycle high-voltage transmission lines.

Engineering details

Patents normally don't give many quantitative specifics, but Tesla's wireless power patent does give some about the big prototype power-transmission Tesla coil (which was, incidentally, used to conduct a demonstration before skeptical patent examiners). A 50,000-volt transformer charged a capacitor of .004 mfd., which discharged through a rotary gap that gave 5,000 breaks per second. The eight-foot diameter primary had just one turn of stout stranded cable. The secondary was 50 turns of heavily insulated No. 8 wire wound as a flat spiral. It vibrated at 230-250,000 cycles and produced 2 to 4 million volts. This coil evolved into the huge experimental magnifying transmitter

Tesla describes in his Colorado Springs notes. Housed in a specially built lab 110 feet square, the device used a 50,000 volt Westinghouse transformer to charge a capacitor that consisted of a galvanized tub full of salt water as an electrolyte, into which he placed large glass bottles, themselves containing salt water. The salt water in the tub was one plate of this capacitor, the salt water inside the bottles the other plate, and the bottle glass the dielectric. Various capacities were tried, incremental changes being made by connecting more or fewer bottles. A variable tuning coil of 20 turns was connected to the primary, which consisted of two turns of heavy insulated cable that ran around the base of the huge fence like wooden secondary framework. The secondary had 24 turns of No. 8 wire on a diameter of 51 feet. Various extra coils were tried, the final version being 12 feet high, 8 feet in diameter, and having 100 turns of No. 8 wire.

The antenna was a 30-inch conductive ball adjustable for height on a 142-foot mast. The huge transmitter could vibrate from 45 to 150 kilocycles. Even with the big transformer, this bill of materials does not seem inaccessible to enterprising people, and the technology does not seem so abstruse, so

it is no wonder that people have gotten together to build magnifying transmitters and experiment with wireless power without support from corporations or government.

One such group was the People's Power Project in central Minnesota in the late 70's. This group, largely farmers, objected to high voltage power lines trespassing on their land and set out to build an alternative. Limited by the sketchy information then available, the project was not successful. Another attempt, called Project Tesla, is being set up in Colorado. Endowed with more precise calculations and more experienced personnel, Project Tesla will try to repeat Tesla's wireless-power experiment and verify his theory by taking measurements at various remote locations.

Earth resonance

Among the appealing features of Colorado Springs for Tesla was the region's frequent and sensational electrical storms. For Tesla, lightning was a joyous phenomenon. Biographers report that, during storms back East, Tesla would throw open the windows of his New York lab and recline on a couch for the duration, muttering to himself ecstatically. In Colorado Springs he tuned in and tracked lightning storms using rudimentary radio receiving equipment. He thereby determined that lightning was a vibratory phenomenon, which set up standing waves bouncing within the earth at a frequency resonantly compatible with the earth's electrical capacity. This earth-resonant frequency, he reasoned, was the ideal frequency for wireless power transmission, and he tuned his ultimate magnifying transmitter accordingly.

The literature contains various reports on exactly what this frequency is. Some say 150 kilocycles, which would be at the upper range of the Colorado Springs transmitter. Others give frequencies considerably lower, 11.78 cycles, 6.8 cycles, frequencies Tesla's transmitter may have achieved harmonically. With reinforcement from the earth resonance, the power would actually increase in the process of transmission.

In one memorable experiment with the Colorado Springs transmitter, Tesla shot from the antenna ball veritable lightning bolts of 135 feet, producing thunder heard 15 miles distant, and, in the process, pulled so many amperes that he burned out the municipal generator. In another experiment he lit up wirelessly, at a distance of 26 miles from the lab, a bank of 10,000 watts worth of incandescent bulbs. Two years after Colorado Springs, Tesla applied for patent for the far more refined magnifying transmitter shown at the opening of this chapter, a patent that was not granted until a dozen years later.

In this patent he no longer speaks of energy broadcast through the upper strata of the atmosphere but of a grounded resonant circuit. Tesla predicted that his magnifying transmitter would prove most important and valuable to future generations, that it would bring about an industrial revolution and make possible great humanitarian achievements. Instead, as we shall see, the magnifying transmitter became Tesla's Waterloo.

5. Magnifying Transmitter II ; Grounded Radio:

With the backing of J. P. Morgan, Tesla began, soon after returning from Colorado Springs, the construction of a magnifying transmitter tower at Wardencllyffe, near Shoreham, Long Island. Though

closely related to a wireless power propagator and intended for further experimentation in that area, the tower was built specifically as the first station in Tesla's proposed World System of broadcasting. The system was to carry programming for the general public as well as private communications.

Tesla was the first to suggest the broadcasting of news and entertainment to the public; only point-to-point signaling had been experimented with up to then. The fully realized World System was to serve as a multi-frequency wireless interconnects for all existing telephone, telegraph, and stock ticker services around the planet. Exclusivity and noninterference of priority private communications was to be assured by multiplex techniques. The giant transmitter was also to carry a universal time register, navigation beacons, and facsimile transmissions. This was in 1902. As we shall see, Tesla's massive contribution to radio is still largely unrecognized.

The Wardencllyffe tower's rugged wooden structure, designed by Stanford White, stood at 187 feet. It was topped by a mushroom-like terminal 68 feet in diameter. A separate brick building at the foot housed generating and other equipment. The entire project was to cover 200 acres and include housing for 2,000 employees of the facility. Tesla estimated that the tower would emit a wave complex of a total maximum activity of 10 million horsepower. The top of the tower was outfitted with a platform that may have been intended to accommodate powerful ultraviolet lamps, which Tesla could have used for an experimental beam system of electric power transmission that was on his mind. The tower structure and building beneath were built and partially equipped, but they never saw operation.

From: **A MUSEUM AT WARDENCLYFFE - THE CREATION OF A MONUMENT TO NIKOLA TESLA**

The year was 1900 and following 9 productive months of wireless propagation research in Colorado, Nikola Tesla was anxious to put a mass of new found knowledge to work. His vision focused on the development of a prototype wireless communications station and research facility and he needed a site on which to build. In 1901 he cast his eyes some 60 miles eastward to the north shore village of Woodville Landing. Only six years before the north branch of the Long Island Railroad had opened, reducing travel time to the locality from a horse drawn five hours to less than two. Seeing an opportunity in land development a western lawyer and banker by the name of James S. Warden had purchased 1400 acres in the area and started building an exclusive summer resort community known as Wardencllyffe-On-Sound. With an opportunity for further development in mind, Warden offered Tesla a 200 acre section of this parcel lying directly to the south of the newly laid track. It was anticipated that implementation of Tesla's system would eventually lead to the establishment of a "Radio City" to house the thousands of employees needed for operation of the facility. The proximity to Manhattan and the fairly short travel time between the two, along with the site's closeness to a railway line must surely have been attractive features and Tesla accepted the offer.

The Wardencllyffe World Wireless facility as envisioned by Tesla was to have been quite different from present day radio broadcasting stations. While there was to be a great similarity in the apparatus employed, the method in which it was to be utilized would have been radically different. Conventional transmitters are designed so as to maximize the amount of power radiated from the antenna structure. Such equipment must process tremendous amounts of power in order to counteract the loss in field strength encountered as the signal radiates out from its point of origin. The transmitter at Wardencllyffe was being configured so as to minimize the radiated power. The energy of Tesla's steam driven

Westinghouse 200 kW alternator was to be channeled instead into an extensive underground radial structure of iron pipe installed 120 feet beneath the tower's base. This was to be accomplished by superposing a low frequency baseband signal on the higher frequency signal coursing through the transmitter's helical resonator. The low frequency current in the presence of an enveloping corona-induced plasma of free charge carriers would have pumped the earth's charge. It is believed the resulting ground current and its associated wave complex would have allowed the propagation of wireless transmissions to any distance on the earth's surface with as little as 5% loss due to radiation. The terrestrial transmission line modes so excited would have supported a system with the following technical capabilities:

1. Establishment of a multi-channel global broadcasting system with programming including news, music, etc;
2. Interconnection of the world's telephone and telegraph exchanges, and stock tickers;
3. Transmission of written and printed matter, and data;
4. World wide reproduction of photographic images;
5. Establishment of a universal marine navigation and location system, including a means for the synchronization of precision timepieces;
6. Establishment of secure wireless communications services.

The plan was to build the first of many installations to be located near major population centers around the world. If the program had moved forward without interruption, the Long Island prototype would have been followed by additional units the first of which being built somewhere along the coast of England. By the Summer of 1902 Tesla had shifted his laboratory operations from the Houston Street Laboratory to the rural Long Island setting and work began in earnest on development of the station and furthering of the propagation research. Construction had been made possible largely through the backing of financier J. Pierpont Morgan who had offered Tesla \$150,000 towards the end of 1900. By July 1904, however, this support had run out and with a subsequent major down turn in the financial markets Tesla was compelled to pursue alternative methods of financing. With funds raised through an unrecorded mortgage against the property, additional venture capital, and the sale of X-ray tube power supplies to the medical profession he was able to make ends meet for another couple of years. In spite of valiant efforts to maintain the operation, income dwindled and his employees were eventually dropped from the payroll. Still, Tesla was certain that his wireless system would yield handsome rewards if it could only be set into operation and so the work continued as he was able. A second mortgage in 1908 acquired again from the Waldorf-Astoria proprietor George C. Boldt allowed some additional bills to be paid, but debt continued to mount and between 1912 and 1915 Tesla's financial condition disintegrated. The loss of ability to make additional payments was accompanied by the collapse of his plan for high capacity trans-Atlantic wireless communications. The property was foreclosed, Nikola Tesla honored the agreement with his debtor and title on the property was signed over to Mr. Boldt. The plant's abandonment sometime around 1911-1912 followed by demolition and salvaging of the tower in 1917 essentially brought an end to this era. Tesla's April 20, 1922 loss on appeal of the judgment completely closed the door to any further chance of his developing the site.

Tesla; the Father of Radio?

As we have seen, Tesla's earliest oscillators were dynamos, but, having determined that he could not reach the higher frequencies by this means, he went on to develop the spark gap oscillator, the Tesla coil, and the magnifying transmitter. But did any of these devices become the first to be used for overseas radio transmission? No, ironically, the first commercial overseas transmitter was a 21.8 kilocycle GE Alexanderson alternator operated by RCA, a design evolved straight out of Tesla's early dynamos. Such was Tesla's luck in radio.

Official histories often credit Tesla with the poly phase system and either ignore his later inventions altogether or dismiss them as the work of a crackpot. But among those who have published honest research on the subject, there is one hundred percent consensus that Tesla was cheated out of his rightful place in history, particularly his status as the leading inventor of radio technology.

Radio simplified

Early radio devices are fascinating and worthy of study if only because they remind us that powerful radio technologies can be so simple and accessible to anyone, the present-day micro complexity notwithstanding. As we have seen, the earliest transmitters in wide use by amateurs were not alternators but spark-gap oscillators. To get on the air all you needed was a battery, a telegraph key, an induction coil, a spark gap, a length of wire as an antenna, and a ground. Of course, the addition of a capacitor juiced it up considerably.

The very earliest experiments in radio receiving used spark gaps as receivers. When you saw an arc across the gap, this was the detection of a disturbance in the medium. This evolved into a detector called a coherer. This is just a horizontal glass tube loosely filled with metal chips (iron, nickel). It is placed in series with a battery and a telegraph sounder, and one side of the coherer goes to the antenna, the other to ground.

The coherer is a switch (a semiconductor, really) that conducts when there is a disturbance of the medium. The more easily conducted radio-frequency energy triggers conduction of this almost conductive material. To get the coherer back to a non conducting state requires a tap that can be accomplished manually or by mechanical linkage to the telegraph sounder. Tesla comes into the technology about here. He improves the coherer by putting it into continual rotation (rotating coherer) so it didn't need a tap to reset.

Tuned radio

The spark gap transmitter was indiscriminate as to the frequency of the disturbance. It put out a dirty complex of frequencies consisting of a rough fundamental determined by width of gap, together with parasitic oscillations, harmonics splatter what-have-you. The coherer was set off by any disturbance. In Colorado Springs, Tesla used a rotating coherer to track electrical storms. The celebrated Marconi units employed nothing more evolved than this crash method of signaling.

So why is Marconi so famous? It is because, like Edison and Westinghouse, he built up an industry around the invention and made himself famous in the course of promoting his enterprise. Marconi's

company was ultimately incorporated into RCA (now incorporated into General Electric). It owed much of its technological development to ideas lifted from the likes of Tesla. Tesla's contribution was nothing less than selective tuning. He set forth the principle of resonantly tuned circuits in his Tesla coil patent of 1896, and the principles of transmitter-receiver tuned circuits a year later in his wireless power patent.

The Tesla coil is a powerful and simple radio transmitter. If the primary circuit is smoothly vibrating well above the audio range, its signal can even be modulated for voice transmission by varying some circuit element.

Tesla's few published notes on modulation describe crude ways of varying spark gaps, but, conceivably, an inductance core mechanically linked to a loudspeaker transducer might modulate the signal with some fidelity. Tesla and his supporters waged a fight for recognition of Tesla as the founder of radio. The struggle was finally won in the Supreme Court, but this did not happen until shortly after Tesla's death.

Tesla vs. Hertz

Tesla was not a theoretician by calling, but he made plenty of observations on the electrical nature of the universe that put him at odds with official theory. In fashion then (and even now) was the theory of Heinrich Hertz, an interpreter of the physics of James Maxwell. Hertz explained radio propagation as transverse waves akin to light. Tesla was convinced that radio disturbances were standing waves in the ether akin to sound. When you drop a pebble into water, the disturbances you see in the form of concentric circles are standing waves.

Both Tesla and Hertz assumed the existence of an aetheric medium, but differed as to its energy transmitting properties. Tesla believed that the ether was a gas like medium, that electric propagation was very much like that of sounds in air, alternate compression's and rarefaction's of the medium, and that Hertzian waves could only take place in a solid medium. Tesla once said that Hertz waves are radiation and that no energy could be economically transmitted to a distance by any such agency. He said, In my system, the process is one of true conduction which can be effected at the greatest distance without appreciable loss.

When quantum physics and particle theory came into vogue, the aetheric medium was dropped out of electric theory altogether, but Hertz's theory was more compatible with the new concepts of propagation and therefore survived. By way of rubbing this in, the unit of frequency, formerly cycles per second (cps), was renamed in honor of Hertz (Hz), while only an obscure unit of magnetic flux density remembers Tesla. It is in respect to Tesla that I have reverted to the old unit in this book. Hertzian radio is straight-line, light-like radiation's that bounce off hills and mountains. Long distance Hertzian transmissions are explained in terms of radiation's bouncing off a radio reflective upper layer called the ionosphere. Tesla thought this was all nonsense and declared in 1919 that Hertzian thinking has stifled creative effort in the wireless art and retarded it for 25 years. Hertzian radio is aerial.

Most of us are conditioned to thinking in terms of aerial radio; the air waves, on the air. Tesla's radio is grounded; the lower end of the energized coil is rooted in the earth. Pure Hertzian radio has no such

natural load. Tesla doesn't speak of antennas as such; the element he places aloft is an elevated capacity. Tesla said radio devices should be designed with due regard to the physical properties of this planet and the electrical conditions obtaining in same. Grounded radio is indeed more powerful than the Hertzian aerial. But this is true particularly for the frequencies Tesla was using. The higher frequencies do behave in a Hertzian manner. Yet grounding is all but a lost concept in consumer electronics. Up through the 1940's, AM radio receivers customarily had a terminal one was encouraged to connect to a cold water pipe or other deep earth connection. Ground the chassis of any of today's receivers, and, unless there is some kind of interference coming up through the ground (from fluorescent circuits, light dimmers, which are oscillators, or from the local Tesla coil), you will usually improve signal strength and range.

Among Tesla's contributions to radio was remote control. Tesla demonstrated a radio-controlled boat before crowds at Madison Square Gardens and sent another robot craft 25 miles up the Hudson River. Grounded radio works particularly well through water. Tesla's basic radio tuning tank circuit for receiving (coil plus capacitor between antenna and ground) was, and is, all by itself, a powerful signal amplifier, and a beautifully simple one, at that. But as radio developed over the years, the tank circuit shrank in size and the result was a loss in gain. This was compensated for by the addition of stage upon stage of complex amplification circuitry.

Tesla watched this development with bewilderment. Tesla knew that the most efficient long-distance radio took place in the lower frequencies, especially those close to the earth-resonant frequency. Frequencies well below the AM broadcast band were the favored ham frequencies in the early days prior to World War I. In fact, waves of 600 meters (500 kc) were considered short while considered fairly long were the waves of 1200 meters (25 kc). Like a lot of good real estate, many of these more radio-effective frequencies below the AM broadcast band have been appropriated for military use, but also for navigation beacons, weather stations, and time registers.

Underground radio

The mind conditioned by Hertzian aerial radio concepts has trouble grasping the idea that signaling can take place without any above-surface antenna, totally through the ground. James Harris Rogers, taking a cue from Tesla, circa World War I, built a radio system in which both sending and receiving antennas were sunk completely into the ground or submerged in bodies of water. He found this system far more effective and far less vulnerable to interference than any aerial radio. Signal strength has been said to be 5,000 times stronger.

The military is on to this, as evidenced in the Navy's ELF and by a U. S. Air Force project underway called Ground Wave Emergency Network. GWEN is a low-frequency communications system designed for use during a nuclear war. The network will have a cross-continent series of 600-foot diameter underground copper screens connected to 300-foot towers reminiscent of Tesla's Wardencliff.

Among the advantages of the system is its invulnerability to the effects of the electric pulse sent out by nuclear blasts. Such a pulse fries at one stroke any and all solid-state electronics within its extensive range. (Strong electric vibrations from a Tesla coil or magnifying transmitter have a similar effect on

solid state and will scramble or disable such circuitry temporarily or even dud it permanently.) It's revealing that for last-ditch doomsday communications, the government reverts to Tesla's grounded radio.

J. P. Morgan sinks Tesla

Tesla's ambitious World System came to an end when its principal financier, J. P. Morgan pulled the plug on funding. Morgan, the financial giant behind the formation of many monopolies in railroads, shipping, steel, banking, etc., was a major conduit of European capital into U. S. industrial development in the Robber Baron era. He looms large in Tesla's life. Morgan money was in the Niagara Falls project. He backed Edison, too. It was Morgan's pressure on Westinghouse, whom he also financed, that caused the cancellation of Tesla's dollar-a-horsepower contract and the loss of millions in royalties to Tesla for his poly phase.

When Tesla's lab burned down (arson was suspected), one of Morgan's men promptly arrived with aid, as well as with the offer of a partnership with Morgan interests. Acceptance would have put Tesla firmly under Morgan's control. Tesla refused. And Tesla succeeded in preserving his autonomy until he became possessed with overwhelming ardor to fulfill the dream of his World system. Tesla was ready to sell his soul to finance Wardenclyffe, and J. P. Morgan was right there to buy it.

In 1901, Tesla signed over to Morgan controlling interest in the patents he still owned, as well as all future ones, in lighting and radio. Morgan then put about \$150,000 startup funding into Wardenclyffe. Later he invested more, just enough to bring the project within sight of completion. Morgan then became elusive. Tesla tried desperately to communicate with the investor, but to no avail. When word was out on Wall Street that Morgan had withdrawn support, no one would touch the project. This finished Tesla as a functioning inventor. Work on the Wardenclyffe tower came to a halt. Left to dereliction, the tower remained only as a curiosity to passersby. During World War I, the tower was unceremoniously dynamited to the ground.

6. Lighting

In 1891 Tesla said that existing methods of lighting were very wasteful, that some better methods must be invented, some more perfect apparatus devised. Tesla went and did just that. Yet, here we are today, in a world lit predominantly by the same Edison bulb! Edison's bulb burns with six percent efficiency, the rest going off as heat, while the high resistance filament cooks at 4,000 degrees and eventually breaks without warning. Today's fluorescent tube, though inspired by Tesla, is no model of efficiency either.

Its inner surfaces are stimulated to phosphorescence by energy-consuming filament-like cathodes that also burn out, and the lit-up tube would present a dead short to the current if it were not for the so-called ballast transformer, an inductance placed in the circuit to oppose and thus eat up yet more current. What sent Tesla into an exploration of high frequency phenomena was his conviction that these rapid vibrations held the key to a superior mode of lighting. The explorations were not Tesla's first venture into lighting. His very first U. S. patent (1885) is for an improvement in the arc lamp. He used an electromagnet to feed carbons to the arc at a uniform rate to produce a steadier light (No.

335,785).

Early arc lamps produced a brilliant blue-white light, good for street lighting but not for the home, and they emitted noxious fumes. Home lighting was by gas. Street arc lighting used series circuits. Edison introduced the parallel circuit, and designed his lamp for such a circuit. Edison introduced the big scale production and sale of electric power itself on the model of gas lighting, a major industry at the time. He wanted to be first in the business and announced to the press that he had an operable bulb before he actually had a bulb that worked. When Tesla's a.c. system was established, it was grafted on to Edison's, greatly extending its range and efficiency. But, essentially, it was still Edison's parallel circuit, high consumption, incandescent lighting system, and this is what we have to live with today.

A better way

Tesla patented both his spark-gap oscillator and his Tesla coil specifically as power sources for a new lighting system that used currents of high frequency and high potential. Lest you get the impression that a lone genius named Tesla invented this new form of lighting out of the blue, you should know that others before him had used high frequencies to stimulate light, and others, like Sir William Crookes, had done the same with high potentials, but Tesla was the first on record to put the two together.

In Jules Verne's 1872 novel *A Journey to the Center of the Earth*, the narrator tells of a brilliant portable battery lamp used by the underground explorers. The device was powered by a Ruhmkorf coil; a high voltage buzzer-type induction coil (step-up transformer) popular among early electrical experimenters. The Ruhmkorf coil stimulated a lamp (type unspecified but probably a gas tube), which produced the light of an artificial day. The lamp had such a low current draw that the battery lasted throughout the subterranean adventure. Verne evidently was drawing, at least in part, on experimental knowledge of his day for what he calls this ingenious application of electricity to practical purposes.

Perhaps somebody should reinvent such a high potential lamp to replace today's flashlight, which seems to exist for the purpose of enriching the Eveready division of Union Carbide. Modern neon lighting is high potential at 2,000 to 15,000 volts. (Neon sign transformers are good for powering tesla coils, but a low-frequency, high voltage device: caution.) Neon, as well as its cousin, 7,500-volt cold cathode (filament's) fluorescent, which is used in some industrial lighting, is as close as we get to Tesla lighting today.

Circa 1900, Tesla experimented with luminous tubes bent into alphabetic characters and other shapes. Although today's neon is simplistic Tesla, being driven by 60-cycle high-voltage transformer power alone without the benefits of high-frequency excitation, it should suggest to us the amazing efficiency of high-potential lighting, since a single 15,000-volt neon transformer drawing only 230 watts can light up a tube extending up to 120 feet. How superior is the economy of Tesla high potential, high frequency lighting over Edison incandescent? Tesla says certainly 20 times, if not more light is obtained for the same expenditure of energy.

"Pure" light

Tesla invented a variety of lamps, not all of which show up in his patents. He lit up solid bodies like

carbon rods in vacuum bulbs, or in bulbs containing various inert gases at low pressure (rarefied). He noted that tubes devoid of any electrodes may be used, and there is no difficulty in producing by their means light to read by. But he noted that the effect is considerably increased by the use of phosphorescent bodies, such as yttrium, uranium glass, etc. Here Tesla lays the foundation for fluorescent lighting. Applied to such lamps were currents at potentials ranging from a lower limit of 20,000 volts up to voltages in the millions and vibrations of 15,000 cycles per second and up.

Tesla dreamed of creating what he called pure light or cold light by generating electric vibrations at frequencies that equaled those of visible light itself. Light produced by this direct and efficient means would require vibrations of 350 to 750 billion cycles, but Tesla believed such oscillations, far above those attainable by his coils, would someday be achieved. Even so, his rarefied gas-tube lamps produced a light that more closely approximated natural daylight than any other artificial source Tesla's light is like the full-spectrum light that is coming to be recognized as far more healthful than Edison incandescent and particularly more healthful than conventional fluorescent. Full-spectrum lighting is believed by some health practitioners actually to have healing properties.

No sudden burnout

Tesla's gas tube lamps burn indefinitely, as do today's neon tubes, for there is nothing within to be consumed. Tesla's lamps that contain electrodes like carbon rods, however, do undergo some deterioration. In Tesla's words, a very slow destruction and gradual diminution in size always occurs, as in incandescent filaments; but there is no possibility of sudden and premature disabling which occurs in the latter by the breaking of the filament, especially when incandescent bodies are in the shape of blocks. In vacuum lamps, the life of the bulb depends upon the degree of exhaustion, which can never be made perfect. Also, the higher the frequency applied to such a lamp the slower the deterioration. Electrodes glow at high temperatures, and this raises the problem of how to conduct energy to them since wires or other metallic elements will melt. The problem must be addressed in lamp design. For example, in the incandescent lamp shown at the opening of this chapter, the lead-in wires connect to the hot electrodes via bronze powder contained in a refractory cup. Tesla may have designed his capacitor-base bulbs to help address this same problem.

High heat

Tesla's search for the ideal electrode is reminiscent of Edison's search for the long lasting filament: The production of a small electrode capable of withstanding enormous temperatures, said Tesla, is regarded as the greatest importance in the manufacture of light. One of the electrodes he tried was a small button of carbon, which he placed in a near vacuum. Tesla regarded the high incandescence of the button to be a necessary evil. For lighting purposes, it was the incandescence of the gas remaining in the mostly evacuated chamber that was important. But the carbon-button lamp proved to have some remarkable properties beyond its use for illumination. When the voltage was turned up, the lamp produced such tremendous heat that the carbon button rapidly vaporized. Tesla experimented extensively with this fascinating phenomenon. For the button of carbon he substituted zirconium, the most refractory substance available at the time. It fused instantly. Even rubies vaporized. Diamonds, and, to a greater degree, carborundum, endured the best, but these could also be vaporized at high potentials.

Tesla worked on the problem of heating. I have read that he contributed to the development of a high-frequency induction heating. Did Tesla work on the problem of space heating? Certainly the huge current draw of conventional electric heaters, which use resistive elements, argues for some inventiveness in this area. Tesla did observe that the discharges from a tesla coil resembled flames escaping under pressure and were indeed hot. He reflected that a similar process must take place in the ordinary flame, that this might be an electric phenomenon. He said that electric discharges might be a possible way of producing by other than chemical means a veritable flame which would give light and heat without material consumed. The behavior of the carbon-button lamp suggests that a new heating mode might be found in the effects of high-frequency currents in a vacuum.

Lighting up the sky

Hold a fluorescent tube near a Tesla coil and it will light up in your hand. This is true of any tube or bulb with vacuum or rarefied gas. A more efficient way is to ground one end of the tube and put a length of wire as a sort of antenna on the other. Better yet, put a coil of wire that resonates with the secondary in series with the tube and ground and you have the optimal wireless power arrangement.

Tesla conducted many experiments with different arrangements like this, using on some occasions the widely available Edison filament incandescent, which lighted up more brilliantly than usual because of the effects of high frequencies on the bulbs rarefied interior. Inside his New York lab Tesla strung a wire connected to a tesla coil around the perimeter of the room. Wherever he needed light he hung a gas tube in the vicinity of this high frequency conductor.

Tesla had a bold fantasy whereby he would use the principle of rarefied gas luminescence to light up the sky at night. High frequency electric energy would be transmitted, perhaps by an ionizing beam of ultraviolet radiation, into the upper atmosphere, where gases are at relatively low pressure, so that this layer would behave like a luminous tube. Sky lighting, he said, would reduce the need for street lighting, and facilitate the movement of ocean going vessels. The aurora borealis is an electrical phenomenon that works on this principle, the effects of cosmic eruptions such as those from the sun being the source of electric stimulation. I, for one, am grateful that this particular Tesla fantasy never materialized since it is difficult enough to see the stars with existing light pollution, and there might be undesirable biological impacts as well.

Rotating brush

Tesla took an evacuated incandescent type lamp globe, suspended within it at dead center a conductive element, stimulated that element with high voltage currents from an induction coil, and thus created a beam-like emanation, a brush discharge that was so eerily sensitive to disturbances in its environs that it seemed to be endowed with an intelligent life of its own. The device works best if there is no lead-in wire. In the bulb shown, every measure has been taken to construct it so it is free from its own electrical influence. The bulb could be stimulated inductively by applying energy to metal foil wrapped around its neck. Thus excited, an intense phosphorescence then spreads at first over the globe, but soon gives place to a white misty light, observes Tesla. The glow then resolves into a directional brush or beam that will spin around the central element. So responsive is it to any electrostatic or magnetic changes in its vicinity that the approach of an observer at a few paces from

the bulb will cause the brush to fly to the opposite side. A small, inch-wide permanent magnet will affect it visibly at a distance of two meters, slowing down or accelerating the rotation according to how it is held relatively to the brush.

Tesla never patented the rotating brush or used it in any practical application, but he believed it could have practical applications. He saw one use in radio where the device could conceivably be adapted to being a most sensitive detector of disturbances in the medium. The rotating brush appears to be a precursor of the plasma globe toys now in fashion; these are sometimes called Tesla globes. Tesla's new lighting was famous in its time. Tesla, the promoter, saw to it. He conducted demonstrations at lectures before the electric industry associations, before large audiences in rented halls, and before select groups of influential New Yorkers in his Manhattan lab.

His articles about the new lighting were published in the popular scientific press and it was reported in the newspapers. Still, it did not catch on with the powers-that-be who no doubt saw in it Tesla's perennial pile-of scrap problem. But, I wonder, would the whole electric distribution system have to be scrapped to implement the efficiencies of Tesla lighting? Conceivably, the new lighting could be run off of local oscillators at the consumer end, the old power distribution system remaining intact. This is still a possibility, as it has been for about one hundred years.

7. Transportation

Tesla speculated, that, perhaps the most valuable application of wireless energy, will be the propulsion of the flying machine, which will carry no fuel and be free from any limitations of the present airplanes and dirigibles. The possibility of electric flight intrigued Tesla, though he never did patent an electric aircraft. But he did patent an electric railway using his high frequency, high-potential electricity in a by-wire mode, and also patented a radical aircraft that, while not electric, did have an advanced power plant: his disk turbine. Tesla's railway and aircraft can be numbered among the lost inventions. The closest transport technology has come to putting any of Tesla into actual practice is with diesel-electric power using Tesla poly phase motors, an early and notable example of which was the ocean liner Normandy. In the field of transport, Tesla is more commonly identified with antigravity flight and UFOs. Although this identification is based upon nothing more than a few public utterances, his suggestions charge the imagination with possibilities.

High-frequency railway

Tesla's high-frequency, high-potential railway picks up its power inductively without the use of the rolling or sliding contacts used in conventional trolley or third-rail systems. A pickup bar travels near a cable carrying the oscillating energy. This cable, which Tesla specifically invented to carry such currents, is the precursor of the grounded shielded cable used today to carry TV and other high-frequency signals. But unlike today's cables, which carry energy only of signal strength and shield by means of a continuous grounded static screen of fine braided copper wire, Tesla's high voltage cable uses metal pipe or screen that is broken up into short lengths, very much shorter, says Tesla in his patent, than the wave lengths of the current used. This feature reduces loss. Since the shielding must not be interrupted, the short sections are made to overlap but are insulated from one another. To further reduce loss to ground, an inductance of high ohmic resistance or a small capacity is placed in

the ground line.

Motor mystery

A conundrum raised by Tesla's railway patent is that the vehicle is powered by an electric motor, but nowhere among Tesla's inventions is to be found an electric motor that runs off of high-frequency currents. Was Tesla planning to use a lower frequency here, something under 1,000 cycles? Did he have a converter in mind that could bring the frequency down? Or did Tesla invent a high-frequency motor that never made it into patent, an invention that may be among his unpublished notes? Anyway, Tesla proceeds in many of his discussions of high-frequency power as if this problem were solved. I've seen references post-Tesla to the existence of such a motor. Free-energy inventor, Hermann Plauson, (next chapter) refers to high-frequency motors. These motors have magnetic cores made of very thin laminations insulated from each other, a design that would limit damping effects.

Turbine aircraft

Tesla's only patented aircraft is a vertical takeoff and landing (VTOL) plane that he intended as an improvement upon the helicopter, already invented at this time (1921): The helicopter type of flying machine, especially with large inclination angle of the propeller axis to the horizontal, at which it is generally expected to operate, is quite unsuitable for speedy aerial transport; it is incapable of proceeding horizontally along a straight line under prevailing air conditions; it is subject to dangerous plunges and oscillations ... and it is almost certainly doomed to destruction in case the motive power gives out. Advances in helicopter design may have mitigated some of these problems, but at least the last one still holds true: Tesla's craft, which has a large wing area, is powered by two disk turbines, rotating in opposite directions. The engineering problem of swinging the pilot and passengers around 90 degrees after takeoff, is solved at least to Tesla's satisfaction. There have been some experimental VTOL's but nothing in production.

Electric flight

Tesla's dream electric aircraft would be powered by means of magnifying transmitters: Aerial machines will be propelled around the earth without a stop. Also, in 1900, he predicted a cold coal battery with such output that a practical flying machine would be possible. Such a battery also would enormously enhance the introduction of the automobile. Tesla fantasized a personal aerial taxi which could be folded into a six-foot cube, and would weigh under 250 lb.: It can be run through the streets and put in a garage, if desired, just like an automobile.

Explaining how his earth-resonant wireless-power system could energize vehicles aloft, he said, power can be readily supplied without ground connection, for, although the flow is confined to earth, an electromagnetic field is created in the atmosphere surrounding it. Tesla believed such a system to be the ultimate method of man-made flight: With an industrial plant of great capacity, sufficient power can be derived in this manner to propel any kind of aerial machine. This I have always considered the best and permanent solution to the problems of flight. No fuel of any kind will be required as the propulsion will be accomplished by light electric motors operated at great speed.

Antigravity

Tesla wrote in 1900 of an antigravity motor: Imagine a disk of some homogeneous material turned perfectly true and arranged to turn in friction less bearings on a horizontal shaft above the ground. Now, it is possible that we may learn how to make such a disk rotate continuously and perform work by the force of gravity. To do so, he said, we have only to invent a screen against this force. By such a screen we could prevent this force from acting on one-half of the disk, and rotation of the latter would follow.

Does it not follow then, that such a gravity screen could also be used to levitate a vehicle? Tesla held no patent on such a device or on any other antigravity device, and there are no published notes on experimentation in the area. Nevertheless, Tesla inevitably pops up in the literature of antigravity and UFOs. This may be because Tesla was a prominent exponent of a physics in which antigravity seems more feasible because gravity is better explained.

A researcher-theorist of today, Thomas Bearden, allows for gravity control in the physics he calls the new Tesla electromagnetic. Scalar (standing) waves in time itself can be produced electrically and this becomes a magic tool capable of directly affecting and altering anything that exists in time, including gravitational fields, says Bearden. In 1931 the editor of Science And Mechanics, Hugo Gernsback reported, It is believed by many scientists today that the force of gravitation is merely another manifestation of electromagnetic waves. Edward Farrow, a New York inventor, reported in 1911 an antigravity effect produced by a ring of spark gaps. When the gaps were fired, the device, called a condensing dynamo, lost one-sixth of its weight. T. Henry Moray wrote, Frequencies may be developed which will balance the force of gravity to a point of neutralization. Antigravity researcher Richard Lefors Clark places the frequency of gravity's vibrations right at Nature's neutral center in the radiant energy spectrum, above radar and below infrared, at 10^{12} cycles per second.

8. Free-Energy Receiver

For starters, think of this as a solar-electric panel. Tesla's invention is very different, but the closest thing to it in conventional technology is in photovoltaic. One radical difference is that conventional solar-electric panels consist of a substrate coated with crystalline silicon; the latest use amorphous silicon. Conventional solar panels are expensive, and, whatever the coating, they are manufactured by esoteric processes. But Tesla's solar panel is just a shiny metal plate with a transparent coating of some insulating material, which today could be a spray plastic. Stick one of these antenna-like panels up in the air, the higher the better, and wire it to one side of a capacitor, the other going to a good earth ground. Now the energy from the sun is charging that capacitor. Connect across the capacitor some sort of switching device so that it can be discharged arrhythmic intervals, and you have an electric output. Tesla's patent is telling us that it is that simple to get electric energy. The bigger the area of the insulated plate, the more energy you get. But this is more than a solar panel because it does not necessarily need sunshine to operate. It also produces power at night Of course; this is impossible according to official science.

For this reason, you could not get a patent on such an invention today. Many an inventor has learned this the hard way. Tesla had his problems with the patent examiners, but today's free-energy inventor

has it much tougher. Tesla's free-energy receiver was patented in 1901 as An Apparatus for the Utilization of Radiant Energy. The patent refers to the sun, as well as other sources of radiant energy, like cosmic rays. That the device works at night is explained in terms of the nighttime availability of cosmic rays.

Tesla also refers to the ground as a vast reservoir of negative electricity. Tesla was fascinated by radiant energy and its free-energy possibilities. He called the Crooke's radiometer (a device which has vanes that spin in a vacuum when exposed to radiant energy) a beautiful invention. He believed that it would become possible to harness energy directly by connecting to the very wheelwork of nature. His free-energy receiver is as close as he ever came to such a device in his patented work. But on his 76th birthday at the ritual press conference, Tesla (who was without the financial wherewithal to patent but went on inventing in his head) announced a cosmic-ray motor. When asked if it was more powerful than the Crooke's radiometer, he answered, thousands of times more powerful.

how it works

From the electric potential that exists between the elevated plate (plus) and the ground (minus), energy builds in the capacitor, and, after a suitable time interval, the accumulated energy will manifest itself in a powerful discharge which can do work. The capacitor, says Tesla should be of considerable electrostatic capacity and its dielectric made of the best quality mica, for it has to with stand potentials that could rupture a weaker dielectric.

Tesla gives various options for the switching device. One is a rotary switch that resembles a Tesla circuit controller. Another is an electrostatic device consisting of two very light, membranous conductors suspended in a vacuum. These sense the energy buildup in the capacitor, one going positive, the other negative, and, at a certain charge level, are attracted, touch, and thus fire the capacitor. Tesla also mentions another switching device consisting of a minute air gap or weak dielectric film, which breaks down suddenly when a certain potential is reached. The above is about all the technical detail you get in the patent.

Plauson's converter

Tesla's invention may have helped to inspire the many other inventors who have worked in the field of free energy. At least a dozen are on record. Let's look at one in particular. In 1921 Hermann Plauson, a German experimenter, succeeded in obtaining patents, including one in the U. S., for Conversion of Atmospheric Electric Energy. In school, every introduction to electricity touches on the phenomenon of so-called static (or electrostatic) electricity, and this is what Plauson means by atmospheric. Static electricity is built-up charge, electricity in a raw state, and it comes easy in Nature, as evidenced by lightning and the aurora borealis.

If you have ever seen a frictional static machine in operation, it's not difficult to imagine the tremendous potential in artificially produced static. A rotating disk type of static machine or the silk belt type, as in the Van de Graff generator, produces discharges like those from a tesla coil. Unfortunately, in school, the subject of static electricity is briefly touched upon and then abruptly dropped, never to be mentioned again. Electrical power sources thereafter are limited to the battery or the wall socket.

How it works

In the Plauson drawing the free energy converter on the left interfaces with a disk type static machine via special pick up combs. When the static collecting disk is rotated, the combs pick up the charge, one comb going positive, and the other negative. The combs, in turn, charge up their respective capacitors until sufficiently high potential builds to jump the spark gap. The oscillatory discharge is induced into the transformer primary. This is high-voltage, high frequency electric energy. The familiar spark-gap oscillator has turned charge into dynamic energy.

The transformer steps down the vibrating high voltage to practical levels to power lighting, heating, and special high-frequency motors. The Plauson patent drawing shows a device that works on the same principle but collects energy by means of an antenna, as does Tesla's receiver. Since the higher the antenna the better, and the more area the better, Plauson favors big metallic helium balloons. Plauson says the safety gap, which has three times the resistance of the working gap, is absolutely necessary for collecting large quantities of charge. The capacitors across the gaps in the series safety gap allow for uniform sparking. Plauson's device suggests that Tesla's might be explained in terms of electrostatics.

Tesla, at the press conference honoring his 77th birthday in 1933 declared that electric power was everywhere present in unlimited quantities and could drive the worlds machinery without the need of coal, oil, gas, or any other fuels. A reporter asked if the sudden introduction of his principle wouldn't upset the present economic system...

Tesla replied, "It is badly upset already."

END

[BACK TO INDEX](#)

Books Music

amazon.com

Enter keywords...

[Click here for the Nikola Tesla and Viktor Schauburger Bookstore, on this site, from](#)

["AMAZON.COM"](#)

[[INDEX](#)]





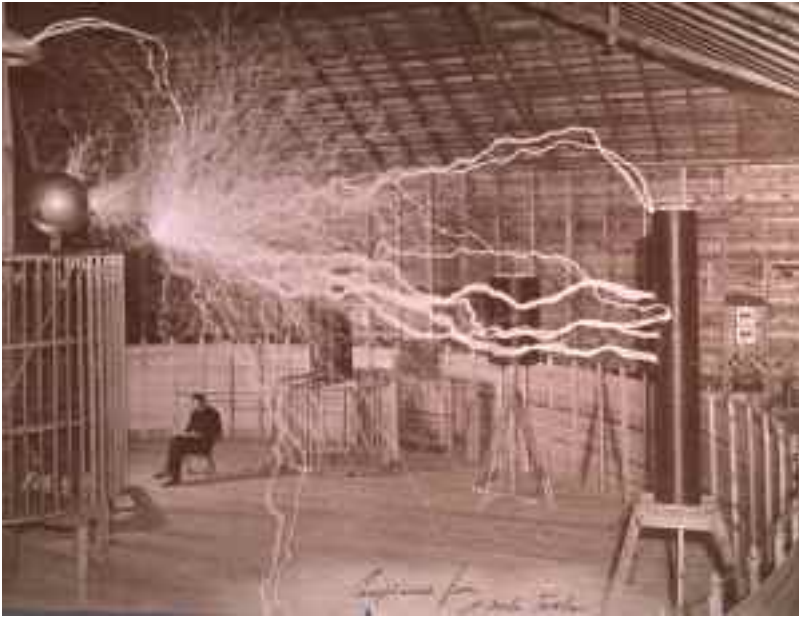

Tesla's Magnifying Transmitter: A compilation of material on this amazing device.

The question has often been posed as to whether Tesla's magnifying transmitter could actually be constructed, today. This webpage will attempt to gather available data, from a historical perspective and offer an opinion.

From: A MUSEUM AT WARDENCLYFFE - THE CREATION OF A MONUMENT TO NIKOLA TESLA

The year was 1900 and following 9 productive months of wireless propagation research in Colorado, Nikola Tesla was anxious to put a mass of new found knowledge to work. His vision focused on the development of a prototype wireless communications station and research facility and he needed a site on which to build. In 1901 he cast his eyes some 60 miles eastward to the north shore village of Woodville Landing. Only six years before the north branch of the Long Island Railroad had opened, reducing travel time to the locality from a horse drawn five hours to less than two. Seeing an opportunity in land development a western lawyer and banker by the name of James S. Warden had purchased 1400 acres in the area and started building an exclusive summer resort community known as Wardencllyffe-On-Sound. With an opportunity for further development in mind, Warden offered Tesla a 200 acre section of this parcel lying directly to the south of the newly laid track. It was anticipated that implementation of Tesla's system would eventually lead to the establishment of a "Radio City" to house the thousands of employees needed for operation of the facility. The proximity to Manhattan and the fairly short travel time between the two, along with the site's closeness to a railway line must surely have been attractive features and Tesla accepted the offer.

The Wardencllyffe World Wireless facility as envisioned by Tesla was to have been quite different from present day radio broadcasting stations. While there was to be a great similarity in the apparatus employed, the method in which it was to be utilized would have been radically different. Conventional transmitters are designed so as to maximize the amount of power radiated from the antenna structure. Such equipment must process tremendous amounts of power in order to counteract the loss in field strength encountered as the signal radiates out from its point of origin. The transmitter at Wardencllyffe was being configured so as to minimize the radiated power. The energy of Tesla's steam driven Westinghouse 200 kW alternator was to be channeled instead into an extensive underground radial structure of iron pipe installed 120 feet beneath the tower's base. This was to be accomplished by superposing a low frequency base-band signal on the higher frequency signal coursing through the transmitter's helical resonator. The low frequency current in the presence of an enveloping corona-induced plasma of free charge carriers would have pumped the earth's charge. It is believed the resulting ground current and its associated wave complex would have allowed the propagation of wireless transmissions to any distance on the earth's surface with as little as 5% loss due to radiation. The terrestrial transmission line modes so excited would have supported a system with the following technical capabilities:

1. Establishment of a multi-channel global broadcasting system with programming including news, music, etc;

2. Interconnection of the world's telephone and telegraph exchanges, and stock tickers;
3. Transmission of written and printed matter, and data;
4. World wide reproduction of photographic images;
5. Establishment of a universal marine navigation and location system, including a means for the synchronization of precision timepieces;
6. Establishment of secure wireless communications services.

The plan was to build the first of many installations to be located near major population centers around the world. If the program had moved forward without interruption, the Long Island prototype would have been followed by additional units the first of which being built somewhere along the coast of England. By the Summer of 1902 Tesla had shifted his laboratory operations from the Houston Street Laboratory to the rural Long Island setting and work began in earnest on development of the station and furthering of the propagation research. Construction had been made possible largely through the backing of financier J. Pierpont Morgan who had offered Tesla \$150,000 towards the end of 1900. By July 1904, however, this support had run out and with a subsequent major down turn in the financial markets Tesla was compelled to pursue alternative methods of financing. With funds raised through an unrecorded mortgage against the property, additional venture capital, and the sale of X-ray tube power supplies to the medical profession he was able to make ends meet for another couple of years. In spite of valiant efforts to maintain the operation, income dwindled and his employees were eventually dropped from the payroll. Still, Tesla was certain that his wireless system would yield handsome rewards if it could only be set into operation and so the work continued as he was able. A second mortgage in 1908 acquired again from the Waldorf-Astoria proprietor George C. Boldt allowed some additional bills to be paid, but debt continued to mount and between 1912 and 1915 Tesla's financial condition disintegrated. The loss of ability to make additional payments was accompanied by the collapse of his plan for high capacity trans-Atlantic wireless communications. The property was foreclosed, Nikola Tesla honored the agreement with his debtor and title on the property was signed over to Mr. Boldt. The plant's abandonment sometime around 1911-1912 followed by demolition and salvaging of the tower in 1917 essentially brought an end to this era. Tesla's April 20, 1922 loss on appeal of the judgment completely closed the door to any further chance of his developing the site.

Nikola Tesla, as quoted from the New York Times, March 27th, 1904 -

"Much has already been done towards making my system commercially available, in the transmission of energy in small amounts for specific purposes, as well as on an industrial scale. The results attained by me have made my scheme of intelligence transmission, for which the name of "World Telegraphy" has been suggested, easily realizable. It constitutes, I believe, in its principle of operation, means employed and capacities of application, a radical and fruitful departure from what has been done heretofore. I have no doubt that it will prove very efficient in enlightening the masses, particularly in still uncivilized countries and less accessible regions, and that it will add materially to general safety, comfort and convenience, and maintenance of peaceful relations."

"It involves the employment of a number of plants, all of which are capable of transmitting

individualized signals to the uttermost confines of the earth. Each of them will be preferably located near some important center of civilization and the news it receives through any channel will be flashed to all points of the globe. A cheap and simple device, which might be carried in one's pocket, may then be set up somewhere on sea or land, and it will record the world's news or such special messages as may be intended for it. Thus the entire earth will be converted into a huge brain, as it were, capable of response in every one of its parts. Since a single plant of but one hundred horsepower can operate hundreds of millions of instruments, the system will have a virtually infinite working capacity, and it must needs immensely facilitate and cheapen the transmission of intelligence."

"The first of these central plants would have been already completed had it not been for unforeseen delays which, fortunately, have nothing to do with its purely technical features. But this loss of time, while vexatious, may, after all, prove to be a blessing in disguise. The best design of which I know has been adopted, and the transmitter will emit a wave complex of a total maximum activity of 10,000,000 horsepower, one percent of which is amply sufficient to "girdle the globe." This enormous rate of energy delivery, approximately twice that of the combined falls of Niagara, is obtainable only by the use of certain artifices, which I shall make known in due course.

"For a large part of the work which I have done so far I am indebted to the noble generosity of Mr. J. Pierpont Morgan, which was all the more welcome and stimulating, as it was extended at a time when those, who have since promised most, were the greatest of doubters. I have also to thank my friend Stanford White, for much unselfish and valuable assistance. This work is now far advanced, and though the results may be tardy, they are sure to come. Meanwhile, the transmission of energy on an industrial scale is not being neglected. The Canadian Niagara Power Company have offered me a splendid inducement, and next to achieving success for the sake of the art, it will give me the greatest satisfaction to make their concession financially profitable to them. In this first power plant, which I have been designing for a long time, I propose to distribute 10,000 horsepower under a tension of 10,000,000 volts, which I am now able to produce and handle with safety."

"This energy will be collected all over the globe preferably in small amounts, ranging from a fraction of one to a few horsepower. One of the chief uses will be the illumination of isolated homes. It takes very little power to light a dwelling with vacuum tubes operated by high frequency currents and in each instance a terminal a little above the roof will be sufficient. Another valuable application will be the driving of clocks and other such apparatus. These clocks will be exceedingly simple, will require absolutely no attention and will indicate rigorously correct time. The idea of impressing upon the earth American time is fascinating and very likely to become popular."

"There are innumerable devices of all kinds which are either now employed or can be supplied and by operating them in this manner I may be able to offer a great convenience to the whole world with a plant of no more than 10,000 horsepower. The introduction of this system will give opportunities for invention and manufacture such as have never presented themselves before. Knowing the far reaching importance of this first attempt and its effect upon future development, I shall proceed slowly and carefully. Experience has taught me not to assign a term to enterprises the consummation of which is not wholly dependent on my own abilities and exertions. But I am hopeful that these great realizations are not far off and I know that when this first work is completed they will follow with mathematical certitude."

"When the great truth, accidentally revealed and experimentally confirmed, is fully recognized, that this planet, with all its appalling immensity, is to electric currents virtually no more than a small metal ball and that by virtue of this fact many possibilities, each baffling imagination and of incalculable consequence, are rendered absolutely sure of accomplishment; when the first plant is inaugurated and it is shown that a telegraphic message, almost as secret and non-interferable as a thought, can be transmitted to any terrestrial distance, the sound of the human voice, with all its intonations and inflections faithfully and instantly reproduced at any other point of the globe, the energy of a waterfall made available for supplying light, heat or motive power, anywhere...on sea, or land, or high in the air...humanity will be like an ant heap stirred up with a stick. See the excitement coming!" "Cloud born Electric Wavelets To Encircle the Globe: This Is Nikola Tesla's Latest Dream, and the Long Island Hamlet of Wardencliff Marvels Thereat," *New York Times*, 27 March 1904.

How it Works:

Rather than acting as a radiator, the large metallic spheroid, now known as an isotropic capacitance, which Tesla positioned above the extra coil was intended only as a reservoir for electrical charge. Another important component of Tesla's Long Island apparatus was an underground array of iron pipes which extended outward from the bottom of a deep shaft beneath the transmitter tower. When coupled with the transmitter these pipes provided a connection to the earth through which a powerful oscillating electrical current would flow. Unlike a conventional radio transmitter with an antenna that radiates dissipating electromagnetic waves out into space, the magnifying transmitter's extra coil excites a low-frequency ground wave called the Zenneck surface wave. In this case the propagating energy does not radiate into space but is concentrated near the earth's surface. Furthermore, Tesla asserted that it is possible to periodically disturb the equilibrium of the earth's electrical charge and cause it to oscillate with his apparatus. This would be accomplished by superposing an extra low frequency baseband signal on the somewhat higher frequency signal coursing through the resonator -- the low frequency current in the presence of an enveloping corona-induced plasma of free charge carriers produced by the oscillator in effect "pumping" the earth's charge.

In Tesla's own words:

"These and other inventions of mine, however, were nothing more than steps forward in a certain directions. In evolving them, I simply followed the inborn instinct to improve the present devices without any special thought of our far more imperative necessities. The "Magnifying Transmitter" was the product of labours extending through years, having for their chief object, the solution of problems which are infinitely more important to mankind than mere industrial development.

If my memory serves me right, it was in November, 1890, that I performed a laboratory experiment which was one of the most extraordinary and spectacular ever recorded in the annals of Science. In investigating the behavior of high frequency currents, I had satisfied myself that an electric field of sufficient intensity could be produced in a room to light up electrode less vacuum tubes. Accordingly, a transformer was built to test the theory and the first trial proved a marvelous success. It is difficult to appreciate what those strange phenomena meant at the time. We crave for new sensations, but soon become indifferent to them. The wonders of yesterday are today common occurrences. When my tubes were first publicly exhibited, they were viewed with

amazement impossible to describe. From all parts of the world, I received urgent invitations and numerous honors and other flattering inducements were offered to me, which I declined. But in 1892 the demand became irresistible and I went to London where I delivered a lecture before the institution of Electrical Engineers.

It has been my intention to leave immediately for Paris in compliance with a similar obligation, but Sir James Dewar insisted on my appearing before the Royal Institution. I was a man of firm resolve, but succumbed easily to the forceful arguments of the great Scotchman. He pushed me into a chair and poured out half a glass of a wonderful brown fluid which sparkled in all sorts of iridescent colors and tasted like nectar. "Now," said he, "you are sitting in Faraday's chair and you are enjoying whiskey he used to drink." (Which did not interest me very much, as I had altered my opinion concerning strong drink). The next evening I have a demonstration before the Royal Institution, at the termination of which, Lord Rayleigh addressed the audience and his generous words gave me the first start in these endeavors. I fled from London and later from Paris, to escape favors showered upon me, and journeyed to my home, where I passed through a most painful ordeal and illness. Upon regaining my health, I began to formulate plans for the resumption of work in America. Up to that time I never realized that I possessed any particular gift of discovery, but Lord Rayleigh, whom I always considered as an ideal man of science, had said so and if that was the case, I felt that I should concentrate on some big idea. At this time, as at many other times in the past, my thoughts turned towards my Mother's teaching. The gift of mental power comes from God, Divine Being, and if we concentrate our minds on that truth, we become in tune with this great power. My Mother had taught me to seek all truth in the Bible; therefore I devoted the next few months to the study of this work.

One day, as I was roaming the mountains, I sought shelter from an approaching storm. The sky became overhung with heavy clouds, but somehow the rain was delayed until, all of a sudden, there was a lightening flash and a few moments after, a deluge. This observation set me thinking. It was manifest that the two phenomena were closely related, as cause and effect, and a little reflection led me to the conclusion that the electrical energy involved in the precipitation of the water was inconsiderable, the function of the lightening being much like that of a sensitive trigger. Here was a stupendous possibility of achievement. If we could produce electric effects of the required quality, this whole planet and the conditions of existence on it could be transformed. The sun raises the water of the oceans and winds drive it to distant regions where it remains in a state of most delicate balance. If it were in our power to upset it when and wherever desired, this might life sustaining stream could be at will controlled. We could irrigate arid deserts, create lakes and rivers, and provide motive power in unlimited amounts. This would be the most efficient way of harnessing the sun to the uses of man. The consummation depended on our ability to develop electric forces of the order of those in nature.

It seemed a hopeless undertaking, but I made up my mind to try it and immediately on my return to the United States in the summer of 1892, after a short visit to my friends in Watford, England; work was begun which was to me all the more attractive, because a means of the same kind was necessary for the successful transmission of energy without wires. At this time I made a further careful study of the Bible, and discovered the key in Revelation. The first gratifying result was obtained in the spring of the succeeding year, when I reaching a tension of about 100,000,000 volts -- one hundred million volts -- with my conical coil, which I figured was the voltage of a flash of lightening. Steady progress was made until the destruction of my laboratory by fire, in 1895, as may be judged from an article by T.C. Martin which appeared in the April number of the Century

Magazine. This calamity set me back in many ways and most of that year had to be devoted to planning and reconstruction. However, as soon as circumstances permitted, I returned to the task.

Although I knew that higher electric-motive forces were attainable with apparatus of larger dimensions, I had an instinctive perception that the object could be accomplished by the proper design of a comparatively small and compact transformer. In carrying on tests with a secondary in the form of flat spiral, as illustrated in my patents, the absence of streamers surprised me, and it was not long before I discovered that this was due to the position of the turns and their mutual action. Profiting from this observation, I resorted to the use of a high tension conductor with turns of considerable diameter, sufficiently separated to keep down the distributed capacity, while at the same time preventing undue accumulation of the charge at any point. The application of this principle enabled me to produce pressures of over 100,000,000 volts, which was about the limit obtainable without risk of accident. A photograph of my transmitter built in my laboratory at Houston Street, was published in the Electrical Review of November, 1898.

In order to advance further along this line, I had to go into the open, and in the spring of 1899, having completed preparations for the erection of a wireless plant, I went to Colorado where I remained for more than one year. Here I introduced other improvements and refinements which made it possible to generate currents of any tension that may be desired. Those who are interested will find some information in regard to the experiments I conducted there in my article, "The Problem of Increasing Human Energy," in the Century Magazine of June 1900, to which I have referred on a previous occasion.

I will be quite explicit on the subject of my magnifying transformer so that it will be clearly understood. In the first place, it is a resonant transformer, with a secondary in which the parts, charged to a high potential, are of considerable area and arranged in space along ideal enveloping surfaces of very large radii of curvature, and at proper distances from one another, thereby insuring a small electric surface density everywhere, so that no leak can occur even if the conductor is bare. It is suitable for any frequency, from a few to many thousands of cycles per second, and can be used in the production of currents of tremendous volume and moderate pressure, or of smaller amperage and immense electromotive force. The maximum electric tension is merely dependent on the curvature of the surfaces on which the charged elements are situated and the area of the latter. Judging from my past experience there is no limit to the possible voltage developed; any amount is practicable. On the other hand, currents of many thousands of amperes may be obtained in the antenna. A plant of but very moderate dimensions is required for such performances. Theoretically, a terminal of less than 90 feet in diameter is sufficient to develop an electromotive force of that magnitude, while for antenna currents of from 2,000-4,000 amperes at the usual frequencies, it need not be larger than 30 feet in diameter. In a more restricted meaning, this wireless transmitter is one in which the Hertz wave radiation is an entirely negligible quantity as compared with the whole energy, under which condition the damping factor is extremely small and an enormous charge is stored in the elevated capacity. Such a circuit may then be excited with impulses of any kind, even of low frequency and it will yield sinusoidal and continuous oscillations like those of an alternator. Taken in the narrowest significance of the term, however, it is a resonant transformer which, besides possessing these qualities, is accurately proportioned to fit the globe and its electrical constants and properties, by virtue of which design it becomes highly efficient and effective in the wireless transmission of energy. Distance is then ABSOLUTELY ELIMINATED, THERE BEING NO DIMINUATIONS IN THE INTENSITY of the transmitted impulses. It

is even possible to make the actions increase with the distance from the plane, according to an exact mathematical law. This invention was one of a number comprised in my "World System" of wireless transmission which I undertook to commercialize on my return to New York in 1900.

As to the immediate purposes of my enterprise, they were clearly outlined in a technical statement of that period from which I quote, "The world system has resulted from a combination of several original discoveries made by the inventor in the course of long continued research and experimentation. It makes possible not only the instantaneous and precise wireless transmission of any kind of signals, messages or characters, to all parts of the world, but also the inter-connection of the existing telegraph, telephone, and other signal stations without any change in their present equipment. By its means, for instance, a telephone subscriber here may call up and talk to any other subscriber on the Earth. An inexpensive receiver, not bigger than a watch, will enable him to listen anywhere, on land or sea, to a speech delivered or music played in some other place, however distant."

These examples are cited merely to give an idea of the possibilities of this great scientific advance, which annihilates distance and makes that perfect natural conductor, the Earth, available for all the innumerable purposes which human ingenuity has found for a line-wire. One far-reaching result of this is that any device capable of being operated through one or more wires (at a distance obviously restricted) can likewise be actuated, without artificial conductors and with the same facility and accuracy, at distances to which there are no limits other than those imposed by the physical dimensions of the earth. Thus, not only will entirely new fields for commercial exploitation be opened up by this ideal method of transmission, but the old ones vastly extended. The World System is based on the application of the following import and inventions and discoveries:

1) The Tesla Transformer: This apparatus is in the production of electrical vibrations as revolutionary as gunpowder was in warfare. Currents many times stronger than any ever generated in the usual ways and sparks over one hundred feet long, have been produced by the inventor with an instrument of this kind.

2) The Magnifying Transmitter: This is Tesla's best invention, a peculiar transformer specially adapted to excite the earth, which is in the transmission of electrical energy when the telescope is in astronomical observation. By the use of this marvelous device, he has already set up electrical movements of greater intensity than those of lightening and passed a current, sufficient to light more than two hundred incandescent lamps, around the Earth.

3) The Tesla Wireless System: This system comprises a number of improvements and is the only means known for transmitting economically electrical energy to a distance without wires. Careful tests and measurements in connection with an experimental station of great activity, erected by the inventor in Colorado, have demonstrated that power in any desired amount can be conveyed, clear across the Globe if necessary, with a loss not exceeding a few per cent.

4) The Art of Individualization: This invention of Tesla is to primitive Tuning, what refined language is to unarticulated expression. It makes possible the transmission of signals or messages absolutely secret and exclusive both in the active and passive aspect, that is, non-interfering as well as non-interferable. Each signal is like an individual of unmistakable identity and there is

virtually no limit to the number of stations or instruments which can be simultaneously operated without the slightest mutual disturbance.

5) The Terrestrial Stationary Waves: This wonderful discovery, popularly explained, means that the Earth is responsive to electrical vibrations of definite pitch, just as a tuning fork to certain waves of sound. These particular electrical vibrations, capable of powerfully exciting the Globe, lend themselves to innumerable uses of great importance commercially and in many other respects. The "first World System" power plant can be put in operation in nine months. With this power plant, it will be practicable to attain electrical activities up to ten million horsepower and it is designed to serve for as many technical achievements as are possible without due expense.

Among these are the following:

- 1) The interconnection of existing telegraph exchanges or offices all over the world;**
- 2) The establishment of a secret and non-interferable government telegraph service;**
- 3) The interconnection of all present telephone exchanges or offices around the Globe;**
- 4) The universal distribution of general news by telegraph or telephone, in conjunction with the Press;**
- 5) The establishment of such a "World System" of intelligence transmission for exclusive private use;**
- 6) The interconnection and operation of all stock tickers of the world;**
- 7) The establishment of a World system -- of musical distribution, etc.;**
- 8) The universal registration of time by cheap clocks indicating the hour with astronomical precision and requiring no attention whatever;**
- 9) The world transmission of typed or handwritten characters, letters, checks, etc.;**
- 10) The establishment of a universal marine service enabling the navigators of all ships to steer perfectly without compass, to determine the exact location, hour and speak; to prevent collisions and disasters, etc.;**
- 11) The inauguration of a system of world printing on land and sea;**
- 12) The world reproduction of photographic pictures and all kinds of drawings or records..."**

I also proposed to make demonstration in the wireless transmission of power on a small scale, but sufficient to carry conviction. Besides these, I referred to other and incomparably more important

applications of my discoveries which will be disclosed at some future date. A plant was built on Long Island with a tower 187 feet high, having a spherical terminal about 68 feet in diameter. These dimensions were adequate for the transmission of virtually any amount of energy. Originally, only from 200 to 300 K.W. were provided, but I intended to employ later several thousand horsepower. The transmitter was to emit a wave-complex of special characteristics and I had devised a unique method of telephonic control of any amount of energy. The tower was destroyed two years ago (1917) but my projects are being developed and another one, improved in some features will be constructed.

On this occasion I would contradict the widely circulated report that the structure was demolished by the Government, which owing to war conditions, might have created prejudice in the minds of those who may not know that the papers, which thirty years ago conferred upon me the honor of American citizenship, are always kept in a safe, while my orders, diplomas, degrees, gold medals and other distinctions are packed away in old trunks. If this report had a foundation, I would have been refunded a large sum of money which I expended in the construction of the tower. On the contrary, it was in the interest of the Government to preserve it, particularly as it would have made possible, to mention just one valuable result, the location of a submarine in any part of the world. My plant, services, and all my improvements have always been at the disposal of the officials and ever since the outbreak of the European conflict, I have been working at a sacrifice on several inventions of mine relating to aerial navigation, ship propulsion and wireless transmission, which are of the greatest importance to the country. Those who are well informed know that my ideas have revolutionized the industries of the United States and I am not aware that there lives an inventor who has been, in this respect, as fortunate as myself, -- especially as regards the use of his improvements in the war.

I have refrained from publicly expressing myself on this subject before, as it seemed improper to dwell on personal matters while all the world was in dire trouble. I would add further, in view of various rumors which have reached me, that Mr. J. Pierpont Morgan did not interest himself with me in a business way, but in the same large spirit in which he has assisted many other pioneers. He carried out his generous promise to the letter and it would have been most unreasonable to expect from him anything more. He had the highest regard for my attainments and gave me every evidence of his complete faith in my ability to ultimately achieve what I had set out to do. I am unwilling to accord to some small-minded and jealous individuals the satisfaction of having thwarted my efforts. These men are to me nothing more than microbes of a nasty disease. My project was retarded by laws of nature. The world was not prepared for it. It was too far ahead of time, but the same laws will prevail in the end and make it a triumphal success." Nikola Tesla - My Inventions, Ch. 5 & 6 (in part)

Pretty darn powerful words from Tesla. So, we now know that TESLA thought it was possible. Let's see what else we can discover.

Wireless power:

The drawing for Tesla's wireless power patent looks like the earlier power-by-wire patent except now spherical antennas replace the transmission lines, which are dropped out of the picture almost as if they were redundant. The ball antenna is peculiarly Tesla, as is the toroid, and you wonder why nothing like them have appeared since. In this 1900 patent, wireless power is not represented as an earth-resonant

system. Here Tesla talks about transmission through elevated strata. The patent contains much discussion of how rarefied gases in the upper atmosphere became quite conductive when there is applied many hundred thousand or millions of volts. Balloons are suggested to send the antennas aloft. Appreciate that Tesla in this patent has invented nothing less than the principles of radio.

Tesla recognizes only a quantitative difference between sending radio signals and broadcasting electric power. Both involve sending and receiving stations tuned to one another by means of Tesla coil circuits. Tesla's wireless power would be the ultimate centralized electric system, a capitalist dream, but for the fact that the technology is too simple. Just raising an antenna, planting a ground, and connecting simple tesla coil circuitry in between could achieve reception of power.

Although Tesla himself patented a couple of electric meters for high frequencies, it would be all too easy for consumers to tune in for free, just as many today bootleg pay TV signals using illicit equipment far more sophisticated. It is no wonder, then, that the electric power establishment didn't welcome this invention. This was one problem. Another was that the established electric power system would have to be relegated to another great pile of scrap, and maybe the established system of political power as well.

Tesla's announced dream was to use hydra sources where available and through wireless power broadcast that energy around the planet, thus liberating the world from poverty. Such a scheme would not be readily embraced by powers that sustain their rule by keeping populations poor and weak. Centralized control of energy, as well as other resources, is, of course, believed to be essential to civilized rule, at least as far as thinking on that subject has progressed in this era. Moreover, no multinational political system was in existence, or is now for that matter, that could implement a technology of such global implications. Tesla was blind to such considerations.

His commitment, his overriding priority as a technological purist, was to take machine possibilities to their logical conclusions. Today, if wireless power were seriously proposed, there would no doubt be at least one political problem that would not have arisen in Tesla's time: resistance from environmentalists. What would an environmental impact report have to say about biologic hazards? A Navy submarine communication system that uses extremely low frequency (ELF) waves, down to below 10 cycles, has been challenged by environmentalists, as have microwave and 60 cycle high-voltage transmission lines.

Engineering details:

Patents normally don't give many quantitative specifics, but Tesla's wireless power patent does give some about the big prototype power-transmission Tesla coil (which was, incidentally, used to conduct a demonstration before skeptical patent examiners). A 50,000-volt transformer charged a capacitor of .004 mfd., which discharged through a rotary gap that gave 5,000 breaks per second. The eight-foot diameter primary had just one turn of stout stranded cable. The secondary was 50 turns of heavily insulated No. 8 wire wound as a flat spiral. It vibrated at 230-250,000 cycles and produced 2 to 4 million volts. This coil evolved into the huge experimental magnifying transmitter

Tesla describes in his Colorado Springs notes. Housed in a specially built lab 110 feet square, the device used a 50,000 volt Westinghouse transformer to charge a capacitor that consisted of a galvanized tub full of salt water as an electrolyte, into which he placed large glass bottles, themselves containing salt water. The salt water in the tub was one plate of this capacitor, the salt water inside the bottles the other plate,

and the bottle glass the dielectric. Various capacities were tried, incremental changes being made by connecting more or fewer bottles. A variable tuning coil of 20 turns was connected to the primary, which consisted of two turns of heavy insulated cable that ran around the base of the huge fence like wooden secondary framework. The secondary had 24 turns of No. 8 wire on a diameter of 51 feet. Various extra coils were tried, the final version being 12 feet high, 8 feet in diameter, and having 100 turns of No. 8 wire.

The antenna was a 30-inch conductive ball adjustable for height on a 142-foot mast. The huge transmitter could vibrate from 45 to 150 kilocycles. Even with the big transformer, this bill of materials does not seem inaccessible to enterprising people, and the technology does not seem so abstruse, so it is no wonder that people have gotten together to build magnifying transmitters and experiment with wireless power without support from corporations or government.

One such group was the People's Power Project in central Minnesota in the late 70's. This group, largely farmers, objected to high voltage power lines trespassing on their land and set out to build an alternative. Limited by the sketchy information then available, the project was not successful. Another attempt, called Project Tesla, is being set up in Colorado. Endowed with more precise calculations and more experienced personnel, Project Tesla will try to repeat Tesla's wireless-power experiment and verify his theory by taking measurements at various remote locations.

Earth Resonance:

Among the appealing features of Colorado Springs for Tesla were the region's frequent and sensational electrical storms. For Tesla, lightning was a joyous phenomenon. Biographers report that, during storms back East, Tesla would throw open the windows of his New York lab and recline on a couch for the duration, muttering to himself ecstatically. In Colorado Springs he tuned in and tracked lightning storms using rudimentary radio receiving equipment. He thereby determined that lightning was a vibratory phenomenon, which set up standing waves bouncing within the earth at a frequency resonantly compatible with the earth's electrical capacity. This earth-resonant frequency, he reasoned, was the ideal frequency for wireless power transmission, and he tuned his ultimate magnifying transmitter accordingly.

The literature contains various reports on exactly what this frequency is. Some say 150 kilocycles, which would be at the upper range of the Colorado Springs transmitter. Others give frequencies considerably lower, 11.78 cycles, 6.8 cycles, frequencies Tesla's transmitter may have achieved harmonically. With reinforcement from the earth resonance, the power would actually increase in the process of transmission.

In one memorable experiment with the Colorado Springs transmitter, Tesla shot from the antenna ball veritable lightning bolts of 135 feet, producing thunder heard 15 miles distant, and, in the process, pulled so many amperes that he burned out the municipal generator. In another experiment he lit up wirelessly, at a distance of 26 miles from the lab, a bank of 10,000 watts worth of incandescent bulbs. Two years after Colorado Springs, Tesla applied for patent for the far more refined magnifying transmitter shown at the opening of this chapter, a patent that was not granted until a dozen years later.

In this patent he no longer speaks of energy broadcast through the upper strata of the atmosphere but of a grounded resonant circuit. Tesla predicted that his magnifying transmitter would prove most important and valuable to future generations, that it would bring about an industrial revolution and make possible great humanitarian achievements. Instead, as we shall see, the magnifying transmitter became Tesla's Waterloo.

Lighting Up The Sky:

Hold a fluorescent tube near a Tesla coil and it will light up in your hand. This is true of any tube or bulb with vacuum or rarefied gas. A more efficient way is to ground one end of the tube and put a length of wire as a sort of antenna on the other. Better yet, put a coil of wire that resonates with the secondary in series with the tube and ground and you have the optimal wireless power arrangement.

Tesla conducted many experiments with different arrangements like this, using on some occasions the widely available Edison filament incandescent, which lighted up more brilliantly than usual because of the effects of high frequencies on the bulbs rarefied interior. Inside his New York lab Tesla strung a wire connected to a Tesla coil around the perimeter of the room. Wherever he needed light he hung a gas tube in the vicinity of this high frequency conductor.

Tesla had a bold fantasy whereby he would use the principle of rarefied gas luminescence to light up the sky at night. High frequency electric energy would be transmitted, perhaps by an ionizing beam of ultraviolet radiation, into the upper atmosphere, where gases are at relatively low pressure, so that this layer would behave like a luminous tube. Sky lighting, he said, would reduce the need for street lighting, and facilitate the movement of ocean going vessels. The aurora borealis is an electrical phenomenon that works on this principle, the effects of cosmic eruptions such as those from the sun being the source of electric stimulation. I, for one, am grateful that this particular Tesla fantasy never materialized since it is difficult enough to see the stars with existing light pollution, and there might be undesirable biological impacts as well.

The Rotating Brush:

Tesla took an evacuated incandescent type lamp globe, suspended within it at dead center a conductive element, stimulated that element with high voltage currents from an induction coil, and thus created a beam-like emanation, a brush discharge that was so eerily sensitive to disturbances in its environs that it seemed to be endowed with an intelligent life of its own. The device works best if there is no lead-in wire. In the bulb shown, every measure has been taken to construct it so it is free from its own electrical influence. The bulb could be stimulated inductively by applying energy to metal foil wrapped around its neck. Thus excited, intense phosphorescence then spreads at first over the globe, but soon gives place to a white misty light, observes Tesla. The glow then resolves into a directional brush or beam that will spin around the central element. So responsive is it to any electrostatic or magnetic changes in its vicinity that the approach of an observer at a few paces from the bulb will cause the brush to fly to the opposite side. A small, inch-wide permanent magnet will affect it visibly at a distance of two meters, slowing down or accelerating the rotation according to how it is held relatively to the brush.

Tesla never patented the rotating brush or used it in any practical application, but he believed it could have practical applications. He saw one use in radio where the device could conceivably be adapted to being a most sensitive detector of disturbances in the medium. The rotating brush appears to be a precursor of the plasma globe toys now in fashion; these are sometimes called Tesla globes. Tesla's new lighting was famous in its time. Tesla, the promoter, saw to it. He conducted demonstrations at lectures before the electric industry associations, before large audiences in rented halls, and before select groups of influential New Yorkers in his Manhattan lab.

His articles about the new lighting were published in the popular scientific press and it was reported in the newspapers. Still, it did not catch on with the powers-that-be who no doubt saw in it Tesla's perennial pile-of scrap problem. But, I wonder, would the whole electric distribution system have to be scrapped to implement the efficiencies of Tesla lighting? Conceivably, the new lighting could be run off of local oscillators at the consumer end, the old power distribution system remaining intact. This is still a possibility, as it has been for about one hundred years.

A Better Way:

Tesla patented both his spark-gap oscillator and his Tesla coil specifically as power sources for a new lighting system that used currents of high frequency and high potential. Lest you get the impression that a lone genius named Tesla invented this new form of lighting out of the blue, you should know that others before him had used high frequencies to stimulate light, and others, like Sir William Crookes, had done the same with high potentials, but Tesla was the first on record to put the two together.

In Jules Verne's 1872 novel *A Journey to the Center of the Earth*, the narrator tells of a brilliant portable battery lamp used by the underground explorers. The device was powered by a Ruhmkorf coil; a high voltage buzzer-type induction coil (step-up transformer) popular among early electrical experimenters. The Ruhmkorf coil stimulated a lamp (type unspecified but probably a gas tube), which produced the light of an artificial day. The lamp had such a low current draw that the battery lasted throughout the subterranean adventure. Verne evidently was drawing, at least in part, on experimental knowledge of his day for what he calls this ingenious application of electricity to practical purposes.

Perhaps somebody should reinvent such a high potential lamp to replace today's flashlight, which seems to exist for the purpose of enriching the Eveready division of Union Carbide. Modern neon lighting is high potential at 2,000 to 15,000 volts. (Neon sign transformers are good for powering Tesla coils, but a low-frequency, high voltage device: caution.) Neon, as well as its cousin, 7,500-volt cold cathode (filament's) fluorescent, which is used in some industrial lighting, is as close as we get to Tesla lighting today.

Circa 1900, Tesla experimented with luminous tubes bent into alphabetic characters and other shapes. Although today's neon is simplistic Tesla, being driven by 60-cycle high-voltage transformer power alone without the benefits of high-frequency excitation, it should suggest to us the amazing efficiency of high-potential lighting, since a single 15,000-volt neon transformer drawing only 230 watts can light up a tube extending up to 120 feet. ***How superior is the economy of Tesla high potential, high frequency lighting over Edison incandescent? Tesla says certainly 20 times, if not more light is obtained for the same expenditure of energy.***

Tesla's Dreams Of Tomorrow:

"There will be enough wheat and wheat products to feed the entire world, including the teeming millions of China and India, now chronically on the verge of starvation. The earth is bountiful, and where her bounty fails, nitrogen drawn from the air will refertilize her womb. I developed a process for this purpose in 1900. It was perfected fourteen years later under the stress of war by German chemists.

Long before the next century dawns, systematic reforestation and the scientific management of natural resources will have made an end of all devastating droughts, forest fires, and floods. The universal utilization of water power and its long-distance transmission will supply every household with cheap power and will dispense with the necessity of burning fuel. The struggle for existence being lessened, there should be development along ideal rather than material lines.

Today the most civilized countries of the world spend a maximum of their income on war and a minimum on education. The twenty-first century will reverse this order. It will be more glorious to fight against ignorance than to die on the field of battle. The discovery of a new scientific truth will be more important than the squabbles of diplomats. Even the newspapers of our own day are beginning to treat scientific discoveries and the creation of fresh philosophical concepts as news. The newspapers of the twenty-first century will give a mere "stick" in the back pages to accounts of crime or political controversies, but will headline on the front pages the proclamation of a new scientific hypothesis.

"It will be possible to destroy anything approaching within 200 miles. My invention will provide a wall of power," declares Tesla.

Progress along such lines will be impossible while nations persist in the savage practice of killing each other off. I inherited from my father, an erudite man who labored hard for peace, an ineradicable hatred of war. Like other inventors, I believed at one time that war could be stopped by making it more destructive. But I found that I was mistaken. I underestimated man's combative instinct, which it will take more than a century to breed out. We cannot abolish war by outlawing it. We cannot end it by disarming the strong. War can be stopped, not by making the strong weak but by making every nation, weak or strong, able to defend itself.

Hitherto all devices that could be used for defense could also be utilized to serve for aggression. This nullified the value of the improvement for purposes of peace. But I was fortunate enough to evolve a new idea and to perfect means which can be used chiefly for defense. If it is adopted, it will revolutionize the relations between nations. It will make any country, large or small, impregnable against armies, airplanes, and other means for attack. My invention requires a large plant, but once it is established it will be possible to destroy anything, men or machines, approaching within a radius of 200 miles. It will, so to speak, provide a wall of power offering an insuperable obstacle against any effective aggression.

If no country can be attacked successfully, there can be no purpose in war. My discovery ends the menace of airplanes or submarines, but it insures the supremacy of the battleship, because battleships may be provided with some of the required equipment. There might still be war at sea, but no warship could successfully attack the shore line, as the coast equipment will be superior to the armament of any battleship.

I want to state explicitly that this invention of mine does not contemplate the use of any so-called "death rays." Rays are not applicable because they cannot be produced in requisite quantities and diminish rapidly in intensity with distance. All the energy of New York City (approximately two million horsepower) transformed into rays and projected twenty miles, could not kill a human being, because, according to a well known law of physics, it would disperse to such an extent as

to be ineffectual.

My apparatus projects particles which maybe relatively large or of microscopic dimensions, enabling us to convey to a small area at a great distance trillions of times more energy than is possible with rays of any kind. Many thousands of horsepower can thus be transmitted by a stream thinner than a hair, so that nothing can resist. This wonderful feature will make it possible, among other things, to achieve undreamed-of results in television, for there will be almost no limit to the intensity of illumination, the size of the picture, or distance of projection.

I do not say that there may not be several destructive wars before the world accepts my gift. I may not live to see its acceptance. But I am convinced that a century from now every nation will render itself immune from attack by my device or by a device based upon a similar principle." Nikola Tesla

J. P. Morgan "Sinks" Tesla:

Tesla's ambitious World System came to an end when its principal financier, J. P. Morgan pulled the plug on funding. Morgan, the financial giant behind the formation of many monopolies in railroads, shipping, steel, banking, etc., was a major conduit of European capital into U. S. industrial development in the Robber Baron era. He looms large in Tesla's life. Morgan money was in the Niagara Falls project. He backed Edison, too. It was Morgan's pressure on Westinghouse, whom he also financed, that caused the cancellation of Tesla's dollar-a-horsepower contract and the loss of millions in royalties to Tesla for his poly phase.

When Tesla's lab burned down (arson was suspected), one of Morgan's men promptly arrived with aid, as well as with the offer of a partnership with Morgan interests. Acceptance would have put Tesla firmly under Morgan's control. Tesla refused. And Tesla succeeded in preserving his autonomy until he became possessed with overwhelming ardor to fulfill the dream of his World system. Tesla was ready to sell his soul to finance Wardenclyffe, and J. P. Morgan was right there to buy it.

In 1901, Tesla signed over to Morgan controlling interest in the patents he still owned, as well as all future ones, in lighting and radio. Morgan then put about \$150,000 startup funding into Wardenclyffe. Later he invested more, just enough to bring the project within sight of completion. Morgan then became elusive. Tesla tried desperately to communicate with the investor, but to no avail. When word was out on Wall Street that Morgan had withdrawn support, no one would touch the project. This finished Tesla as a functioning inventor. Work on the Wardenclyffe tower came to a halt. Left to dereliction, the tower remained only as a curiosity to passersby. During World War I, the tower was unceremoniously dynamited to the ground.

An eerie prediction from Nikola Tesla that fits right in with today's headlines...

"The truth of this has been borne out in hundreds of instances and I am inviting other students of nature to devote attention to this subject, believing that through combined systematic effort, results of incalculable value to the world will be attained. The idea of constructing an automaton, to bear out my theory, presented itself to me early, but I did not begin active work until 1895, when

I started my wireless investigations. During the succeeding two or three years, a number of automatic mechanisms, to be actuated from a distance, were constructed by me and exhibited to visitors in my laboratory. In 1896, however, I designed a complete machine capable of a multitude of operations, but the consummation of my labours was delayed until late in 1897. This machine was illustrated and described in my article in the Century Magazine of June, 1900; and other periodicals of that time and when first shown in the beginning of 1898, it created a sensation such as no other invention of mine has ever produced. In November, 1898, a basic patent on the novel art was granted to me, but only after the Examiner-in-Chief had come to New York and witnessed the performance, for what I claimed seemed unbelievable. I remember that when later I called on an official in Washington, with a view of offering the invention to the Government, he burst out in laughter upon my telling him what I had accomplished. Nobody thought then that there was the faintest prospect of perfecting such a device. It is unfortunate that in this patent, following the advice of my attorneys, I indicated the control as being affected through the medium of a single circuit and a well-known form of detector, for the reason that I had not yet secured protection on my methods and apparatus for individualization. As a matter of fact, my boats were controlled through the joint action of several circuits and interference of every kind was excluded.

Most generally, I employed receiving circuits in the form of loops, including condensers, because the discharges of my high-tension transmitter ionized the air in the (laboratory) so that even a very small aerial would draw electricity from the surrounding atmosphere for hours. Just to give an idea, I found, for instance, that a bulb twelve inches in diameter, highly exhausted, and with one single terminal to which a short wire was attached, would deliver well on to one thousand successive flashes before all charge of the air in the laboratory was neutralized. The loop form of receiver was not sensitive to such a disturbance and it is curious to note that it is becoming popular at this late date. In reality, it collects much less energy than the aeriels or a long grounded wire, but it so happens that it does away with a number of defects inherent to the present wireless devices.

In demonstrating my invention before audiences, the visitors were requested to ask questions, however involved, and the automaton would answer them by signs. This was considered magic at the time, but was extremely simple, for it was myself who gave the replies by means of the device. At the same period, another larger telautomatic boat was constructed, a photograph of which was shown in the October 1919 number of the Electrical Experimenter. It was controlled by loops, having several turns placed in the hull, which was made entirely watertight and capable of submergence. The apparatus was similar to that used in the first with the exception of certain special features I introduced as, for example, incandescent lamps which afforded a visible evidence of the proper functioning of the machine. These automata, controlled within the range of vision of the operator, were, however, the first and rather crude steps in the evolution of the art of Telautomatics as I had conceived it.

The next logical improvement was its application to automatic mechanisms beyond the limits of vision and at great distances from the center of control, and I have ever since advocated their employment as instruments of warfare in preference to guns. The importance of this now seems to be recognized, if I am to judge from casual announcements through the press, of achievements which are said to be extraordinary but contain no merit of novelty, whatever. In an imperfect manner it is practicable, with the existing wireless plants, to launch an airplane, have it follow a certain approximate course, and perform some operation at a distance of many hundreds of miles.

A machine of this kind can also be mechanically controlled in several ways and I have no doubt that it may prove of some usefulness in war. But there are to my best knowledge, no instrumentalities in existence today with which such an object could be accomplished in a precise manner. I have devoted years of study to this matter and have evolved means, making such and greater wonders easily realizable.

As stated on a previous occasion, when I was a student at college I conceived a flying machine quite unlike the present ones. The underlying principle was sound, but could not be carried into practice for want of a prime-mover of sufficiently great activity. In recent years, I have successfully solved this problem and am now planning aerial machines *devoid of sustaining planes, ailerons, propellers, and other external* attachments, which will be capable of immense speeds and are very likely to furnish powerful arguments for peace in the near future. Such a machine, sustained and propelled *entirely by reaction*, is shown on one of the pages of my lectures, and is supposed to be controlled either mechanically, or by wireless energy. By installing proper plants, it will be practicable to *project a missile of this kind into the air and drop it* almost on the very spot designated, which may be thousands of miles away.

But we are not going to stop at this. Telautomats will be ultimately produced, capable of acting as if possessed of their own intelligence, and their advent will create a revolution. As early as 1898, I proposed to representatives of a large manufacturing concern the construction and public exhibition of an automobile carriage which, left to itself, would perform a great variety of operations involving something akin to judgment. But my proposal was deemed chimerical at the time and nothing came of it. At present, many of the ablest minds are trying to devise expedients for preventing a repetition of the awful conflict which is only theoretically ended and the duration and main issues of which I have correctly predicted in an article printed in the SUN of December 20, 1914. The proposed League is not a remedy but, on the contrary, in the opinion of a number of competent men, may bring about results just the opposite.

It is particularly regrettable that a punitive policy was adopted in framing the terms of peace, because a few years hence, it will be possible for nations to fight without armies, ships or guns, by weapons far more terrible, to the destructive action and range of which there is virtually no limit. Any city, at a distance, whatsoever, from the enemy, can be destroyed by him and no power on earth can stop him from doing so. If we want to avert an impending calamity and a state of things which may transform the globe into an inferno, we should push the development of flying machines and wireless transmission of energy without an instant's delay and with all the power and resources of the nation." Nikola Tesla, My Inventions, Ch. 6 (in part)

So, I leave you with this question - is it possible to re-create Tesla's amazing Magnifying Transmitter? With all of the documentation and notes, plus numerous historical records, and patent information available, doesn't anyone find it a little "odd" and dumfounding that this device has not been put into use? Or, could it be, that in the same ways that J.P. Morgan stopped Tesla...other forces, even more powerful and money-hungry than Morgan he, are currently at work ensuring that this device and others possibly like it, are never built. I leave you all to your thoughts. May God Bless,

Sincerely,

Frank D Germano

President
International Turbine And Power, LLC
931 Rumsey Ave, PO Box 550
Cody, Wyoming
82414
frank@germano.com
<http://www.frank.germano.com>

[BACK TO INDEX](#)

NIKOLA TESLA ON HIS WORK WITH ALTERNATING CURRENTS and Their Application to Wireless Telegraphy, Telephony and Transmission of Power

Leland I. Anderson, Editor

PREFACE

The surfacing of the transcript for this pre-hearing interview with Nikola Tesla by his legal counsel in 1916 resulted from an intensive search in archives of legal firms, some now defunct and others later acquired by contemporary interests. The interview was precipitated by numerous pending court cases as the fledgling radio industry entered a period of fierce competition. Tesla's counsel believed the interview necessary not only in order to prepare for the pressing of his own claims against the Marconi Company, but also to protect his own patent interests when called to give expert-witness testimony in the upcoming litigation foray pitting a plethora of new communication companies and their captive radio pioneers as adversaries.

A case prompting this interview, one of dozens to reach judicial review, was "Marconi Wireless Telegraph Company of America v. Atlantic Communication Company, *et al.*" Atlantic owned and operated the large radio station at Sayville, Long Island. The proceedings opened in 1915 with the calling of expert witnesses including Ferdinand Braun and Nikola Tesla. The specter of war had cast its shadow over Europe, and Count George von Arco, who had also been called, was detained because of services to the German Army in the use of asphyxiating gases and other deadly inventions perfected by him.

The text of this interview was, of course, never intended for publication. Counsel, concerned primarily with the protection of Tesla's patent interests, ask questions almost exclusively relating to the priority of his patents and their application. Tesla candidly discusses his contenders while presenting a thorough history of his work with alternating currents as applied to wireless transmission. In this document, he describes experimental methods, techniques, and apparatus used in his laboratories at New York City, Colorado Springs, and Long Island.

Most of the photographs accompanying this interview are in good condition, but those of schematic and mechanical drawings have suffered some decay with time. These may be the only form of the drawings extant and are reproduced with as much fidelity as possible. For better clarity, five illustrations are reprinted from the February and May, 1913 issues of the *Electrical Experimenter* magazine, Copyright Gernsback Publications, where they subsequently appeared. These are Figures 66, 67, 79, 81 and 82.

Although the interview spanned several days, it is presented in this work as though it was given at one time; all references to interruptions and resumptions have been removed. The text is printed in standard typewriter pica type, unjustified, in the style of hearing proceedings of that period. No alterations have been made in Tesla's remarks except for 'clean-up' additions, typically references to photographs and diagrams, and fill-in words necessitated by occasional rambling and incomplete sentence structure. These additions are provided in brackets []. Helpful notes are also cued to the text in brackets.

L.I.A., 1992

INTRODUCTION

What I am going to show you, step by step, is how I proceeded until I finally realized my dream. Nikola Tesla

You are holding in your hands one of the most remarkable documents in the history of electrical science. Seldom, in technical research, has such a treasure of descriptive commentary and historical documentation been discovered. This book is a veritable Rosetta stone for deciphering and tracing the technical thoughts of one of the world's most distinguished engineering scientists since Archimedes. It describes electrical experiments which took place nearly 100 years ago--but have yet to be replicated. So astonishing are its contents that it takes one's breath away!

Here, in Tesla's own words, are interpretations (couched in the language of 19th century physics) for electrical phenomena which even today lack satisfactory explanations in the language of modern technical analysis. Oh, it won't tell you how to wire up "the magnifying transmitter" (that arcane instrument for global wireless power transmission),* but it will tell you what instruments Tesla was employing, what his thoughts were, how he conceptualized things, how he proceeded, where he performed his historic experiments, when key results were obtained, and how he reached his conclusions. * It may just be that there is enough information present to solve the puzzle of the magnifying transmitter. The reader will have to dig for himself.

Tesla, himself, was awe-struck with the results of his scientific endeavor. He expressed astonishment then at what he later asserts is experimentally demonstrable. Listen to the words he uses in this interview to describe the electrical phenomena to his attorney: "magnificent," "it was a marvelous sight," "a wonderful thing," "practically the lamp of Aladdin," "a tremendous display," "glorious," "so marvelous that one would be almost afraid to talk about them. . . ." An Edmund Spenser or a John Milton could be no more eloquent. One of Shakespeare's characters once said, "Bid me discourse, and I will enchant thine ear." Tesla does no less, even in a legal briefing. He weaves the gossamer web of enchantment, which yet thrills our technical imagination and lures us in, nearly 80 years after a stenographer recorded these spoken words!

Who was Nikola Tesla?

In 1896, at the Franklin Institute in Philadelphia, Lord Kelvin said, "Tesla has contributed more to electrical science than any man up to his time." After showering words of praise upon the inventor before a meeting of the Royal Society in London in 1892, Lord Rayleigh declared that Tesla possessed a great gift for electrical discovery. Fortunately, the text of Tesla's speech has been preserved and republished.^{1,2,3} He was one of the earliest scientists to understand the distinction between lumped and distributed resonance and the first to patent voltage magnification by standing waves.

The unit of magnetic induction is named in honor of Tesla. It is commonly understood by power engineers that he was the inventor of the induction motor utilizing the rotating magnetic field and the AC polyphase power distribution system currently used throughout the civilized world.* However, most electrical engineers are unaware that, as late as 1943, he (not Marconi**) was recognized by the U.S. Supreme Court as having priority in the invention of "radio." Even fewer computer scientists are aware that, when certain computer manufacturers attempted to patent digital logic gates after World War II, the U.S. Patent Office asserted Tesla's turn-of-the-century priority in the electrical implementation of logic gates for secure communications, control systems, and robotics. As a result, a monopoly on digital logic gates was unable to be secured in the 1950s.

* Charles E Scott, past president of the AIEE has said, "The evolution of electric power from the discovery of Faraday in 1831 to the initial great installation of the Tesla polyphase system in 1896 [at Niagara Falls] is undoubtedly the most tremendous event in *all* engineering history. [*Electrical Engineering*, August, 1943 (Vol. 62, No. 8), pp. 351-355.] ** Although it took the courts several decades to figure this out, the facts were well understood by impartial technical men of the day. Robert H. Marriott, the first president of the IRE, once said that Marconi had ". . . played the part of a demonstrator and sales engineer. A money getting company was formed, which in attempting to obtain a monopoly, set out to advertise to everybody that Marconi was the inventor and that they owned that patent on wireless which entitled them to a monopoly." [*Radio Broadcast*, December, 1925 (Vol. 8, No. 2), pp. 159-162.]

Tesla served the electrical engineering profession in its highest offices. In the early 1890s, he was elected as vice-

president of the American Institute of Electrical Engineers, now the Institute of Electrical and Electronics Engineers. At the time of his election, Alexander Graham Bell was its president. Tesla served two years as vice-president of the AIEE and, a decade later, one of his laboratory technicians at the Colorado Springs experiments served as the first vice-president of the Institute of Radio Engineers when it was formed in 1903. This was the now, famous consulting engineer Fritz Lowenstein. Lowenstein was the inventor of the grid biased Class A amplifier (for which he received the sum of \$150,000 from AT&T in 1918), the shaped plate capacitor, and other electrical and mechanical devices. His two IRE papers, with comments on the propagation of ground waves by Zenneck and sky waves by Austin, appeared in February and June issues of the IRE Proceedings, the year of this interview. It should also be noted that Tesla was a fellow of the AIEE, the American Association for the Advancement of Science, and a dozen other professional societies. He received over 13 honorary degrees from such diverse institutions as Columbia, Yale, and the Universities of Paris, Vienna, Prague, and Sofia.

Recently, another fascinating fact about Tesla has come to light. After all these years, it is now known that he was nominated for an *undivided* Nobel prize in physics in 1937. Tesla's nominator, Felix Ehernhaft, of Vienna, had previously nominated Albert Einstein for the Nobel prize.

Tesla had the remarkable talent of charming and astonishing his admirers while at the same time enraging his enemies; the phenomenon continues to the present day. It is unfortunate that, despite several current popular biographies, there still exists no definitive technical authority, other than his own scattered publications, to consult on the scientific issues of his intriguing and colorful scientific career. Consider the adulation bestowed upon him by Lord Kelvin, Hermann von Helmholtz, Sir William Crookes, Lord Rayleigh, Sir James Dewar, Robert Millikan, Sir James Fleming, B.A. Behrend, A. E. Kennally, L.W. Austin, W.H. Bragg, Ferdinand Braun, Jonathan Zenneck, E.W.E Alexanderson, J.S. Stone, Vannevar Bush, W.H. Eccles, Edwin H. Armstrong (who served as a pallbearer at Tesla's funeral, as did Alexanderson), and notably Albert Einstein, Ernest Rutherford, Arthur Compton, and Neils Bohr. There are a number of Nobel laureates, Royal Society fellows, IEEE presidents and fellows, and university presidents in that collection. No one, since Franklin, had so stirred the scientific and engineering world.

In 1893, Thomas Commerford Martin, the third president of the AIEE (1888-1889), edited and published a remarkable collection of Tesla's contemporary lectures. It is in print today, and a century from now it will still be considered an unparalleled classic in scientific literature to be read along with Franklin's *letters*, Priestly's *history*, Faraday's *researches in electricity*, Maxwell's *treatise*, Hertz's *electric waves*, and Heaviside's *electrical papers*. In 1919, 26 years after publishing the work on Tesla, Martin wrote,

"Tesla's influence may truly be said to have marked an epoch in the progress of electrical science. Very little data, however, has been procurable that is descriptive of his later researches, and more is the pity from the historical standpoint. Tesla has not finished. The world waits expectantly for each fresh touch of his vitalizing thought upon the big electrical problem of the age."

Unlike most of the aforementioned scientists, Dr. Tesla; for so it is appropriate to call him, had no financial support to fall back on from a faculty position or research institute. His ideas had to support themselves and him in the technical marketplace. It is not surprising, therefore, that he felt no compulsion to share further technical details in the open scientific literature of his day. For these you must dig (and dig, and dig) through the patent literature, where only enough is disclosed to make it clear to one "skilled in the art."

Readers will also be struck with Tesla's lighter side. His sense of humor and his quick wit shine through when he describes his 1893 RF demonstration before the public at the Sixteenth Convention of the National Electric Light Association in St. Louis, where he was distinguished as honorary member: "There was a stampede in the two upper galleries and they all rushed out. They thought it was some part of the devil's work." (p. 87) His humor is also evident in his description of the influence that his demonstrations had upon the Royal Institution in London in 1892: "The scientists simply did not know where they were when they saw it." (p. 95)

Tesla could also be sarcastic: "The greatest men of science have told me [the Tesla coil] was my best achievement. . . . For instance, a man fills this space with hydrogen; he employs all my instrumentalities, everything that is necessary, but calls it a new wireless system--*I cannot stop it*. Another man puts in here a kind of gap. *He gets a Nobel prize for it*. . . ."

The inventive effort involved is about the same as that of which a 30-year old mule is capable." (p. 48)

Electrical History

For those deeply active in the technical evaluation of historic electrical research, it is a source of intense frustration and shattering disappointment to find "a new book" (or even to have a TV "documentary") appear, only to discover that the authors (a) didn't penetrate the technical aspects of their subject sufficiently to understand what the real issues were, and (b) continue to perpetuate unsubstantiated popularized assertions, myths, and historical errors 'generated at victory balls' and not at the scene of the battle. This is especially true of authors addressing topics in the realm of RF, antennas, and distributed circuits (i.e., radio) where merely an academic knowledge of electronics or Maxwell's theory is insufficient to guarantee professional livelihood in those disciplines. It leads one to conclude that no reliable history of this research can be written until those with adequate technical training and experience devote their time and effort to the subject.

But this document is a breath of fresh air. It sets straight a region of the radio history puzzle which has been incongruous for over nine decades. When we saw these pages, our first impulse was to start an immediate technical evaluation: replicate apparatus, search for partially disclosed concepts and missing pieces, clarify issues, and execute a technical analysis. We believe that this document will initiate considerable activity along these lines, performed as well by a broad spectrum of investigators. This introduction is not an appropriate medium to discuss such pursuits. Instead, we invite the reader to consider the wonderful personal narrative which will be placed before him.

Feel the pathos in Tesla's voice as he describes the famous system of four-tuned circuits: Every wireless message that has ever been transmitted to any distance has been transmitted by this apparatus; there is no other way. Twenty-seven more years would pass before the highest courts of the land would echo in agreement. From those legal proceedings would emerge the acid test for any radio system. For this reason, Tesla, not Hertz, Marconi, or De Forest has been given the title inventor of radio. The courts clearly exercise a distinction between "innovated" and "invention." How strange that, even at this late date, there are those that still don't understand what happened.

Fresh Surprises from Tesla

Tesla has never lost the magical touch. Even today, exactly 100 years after his lecture at the Royal Institution (London), his careful engineering skill still has power to surprise and delight a technical audience. But what was unexpected from Tesla--today, in 1992, is a fresh glimpse of his life's work. Those of us that have toiled with RF technology, and electromagnetic radiation and propagation owe a great debt to Anderson, one of the world's leading authorities on Tesla, for publishing this remarkable document. It is absolutely unique. We have no doubt that it is destined to join *My Inventions; Lectures, Patents, and Articles; Und Sein Werk; Inventionen, Researches and Writings, and Colorado Springs Notes* as a member of the historic "canonical Tesla publications." Anyone doing a serious technical evaluation of Tesla's research must turn to these works.

Return to 1916

It is important to grasp the pulse of society at the time of this interview. In your mind's eye, return to the era of 1916. A Princeton history professor named Woodrow Wilson, the same age as Tesla, will be re-elected to lead the country. War has been raging in Europe for the past 18 months. The Lusitania has been sunk. Within a year, the U.S. would declare war on Germany and more than 100,000 young Americans would go "over there" never to return home to their loved ones. Irving Berlin is writing songs, 24 states have voted-in prohibition, and Ford has produced his millionth automobile. Motorized taxis have just appeared on the streets of New York, and electricity has made possible the new skyscrapers that now begin to dominate the city's skyline.

On Mount Wilson, in California, the new 100-inch telescope is nearing completion. In Europe, Albert Einstein has just introduced the general theory of relativity, and astronomer Arthur Stanley Eddington is quietly preparing expeditions to islands off the coast of Africa and Brazil to test the theory during a solar eclipse. Consultant John Stone Stone has just completed his term as president of the IRE, and Harvard Professor A.E. Kennelly has stepped into the position--he had previously served as president of the AIEE in 1898. The IRE now has almost 1,000 members. Dr. Zenneck's treatise on

wireless telegraphy has just appeared, and he will soon be held "under arrest" at Ellis Island for the duration of WWI. Zenneck would later serve as vice-president of the IRE during 1933.

At Bell Labs, John R. Carson has just shown that single-sideband transmission is mathematically possible. The first transcontinental telephone link has just been demonstrated between Alexander Graham Bell in New York and Thomas A. Watson in San Francisco, and wireless service between the U.S. and Japan has been inaugurated. In 1916 the electromagnetic spectrum is populated only by amateurs and commercial telegraph stations. There is yet no commercial AM broadcasting, although Frank Conrad, who would be vice-president of the IRE 11 years later, has just built an amateur station. It would become Westinghouse's KDKA in November, 1920.

Tesla has recently published "Some Personal Recollections" in the *Scientific American*. He has proposed that the Secretary of Defense create a Defense Science Board. Looking toward the future, he publishes an essay called, "[The Wonder World to be Created by Electricity](#)." E. Taylor Jones and W.M. Jones have published, in the *Philosophical Magazine* (London), erroneous lumped-circuit analyses of Tesla coils. Nineteen years later, one of E.O. Lawrence's proteges at Berkeley would declare, in pages of the *Physical Review*, that Tesla coils "cannot be treated usefully by mathematics."

Tesla prophesies that radio-controlled torpedoes and missiles will soon expose the general population, not just the military, to the horrors of war. In 1916, the *Scientific American* discusses Tesla's new automobile speedometer, the tower at Shoreham (Long Island) will pass from his hands, and Hugo Gernsback's magazine, the *Electrical Experimenter* will contemplate his Colorado Springs experiments. Princes Lwoff-Parlaghy entertains Tesla among New York socialites, and her painting of Tesla appears in *The New York Times*. It will later appear on the cover of *Time* (July 20, 1931).

A Visit to a Law Office

As an unseen guest, you have been ushered into an oak-decorated law office in New York City. Before you sits Nikola Tesla, now 60 years old, still with bushy black hair, slight wrinkles beginning to form around his piercing light blue-grey eyes. He possesses a winning smile and a firm handshake. He wears no jewelry or watch fob. He has a somewhat high-pitched, reedy voice, and speaks quickly and convincingly. He is still very much the cosmopolitan New Yorker in his speech, manner, and demeanor. He has brought with him numerous drawings, papers, and photographs for reference.

Across a wooden table sits his attorney. His demeanor is professional and serious, his questions are penetrating, his manner is deliberate. He is well aware of the professional reputation and international regard of the esteemed gentleman that sits before him, and he is intent upon understanding every detail that he can turn to his client's advantage in the dramatic contests at law which will soon occur. Also present is a stenographer, intent upon providing the attorney with an accurate written transcription of every thought which will soon unfold. The formalities being over, the counselor begins to speak. . . .

K.L. Corum* and J.F. Corum, Ph.D.** April 4, 1992

References: (1) Martin, T.C., *Inventions, Researches and Writings of Nikola Tesla*, The Electrical Engineer, New York, 1893; ch. 27, pp. 123 and 198-293, "Experiments with Alternate Currents of High Potential and High Frequency" by Tesla, February, 1892. This book has been republished and is available from several sources. (2) Popovic, V, Horvat, R., and Nikolic, N., eds., *Nikola Tesla: Lectures, Patents and Articles*, Nikola Tesla Museum, Beograd, Yugoslavia, 1956; ch. 3, "Experiments with Alternate Currents of High Potential and High Frequency" by Tesla, pp. L48-L106. (3) Tesla, Nikola, *Experiments with Alternate Currents of High Potential and High Frequency*, McGraw Publishing Co., New York, 1304, 162 pp. (4) Discussion of "A History of Some Foundations of Modern Radio-Electronic Technology," Comments by Lloyd Espenschied, *Proceedings of the IRE*, July, 1959 (Vol. 47, No. 7), pp. 1254, 1256. (5) Crawford, E., Heilbron, J.L., and Ullrich, R., University of California, 1987. (6) Martin, T.C., and Goles, S.L., *The Story of Electricity*, The Story of Electricity Co., Vol. 2, 1919, p. 107. * Corum & Associates, Inc., Thornton, New Hampshire ** Battelle, Columbus, Ohio

IV. Apparatus for Transformation by Condenser Discharges; Damped Waves

Tesla : This work [Fig. 31] was begun already in 1889. This type of apparatus is identified with my name as certain as the law of gravitation is with that of Newton. I know that some have claimed that Professor Thomson also invented the so-called Tesla coil, but those feeble chirps ne'er went beyond Swampscott. Professor Thomson is an odd sort of man; very ingenious, but he never was a wireless expert; he never could be. Moreover, it is important to realize that this principle is universally employed everywhere. The greatest men of science have told me that this was my best achievement and, in connection with this apparatus [referring to schematics of Fig. 31], I may say that a lot of liberties have been taken. For instance, a man fills this space [break D] with hydrogen; he employs all my instrumentalities, everything that is necessary, but calls it a new wireless system -- the Poulsen arc. I cannot stop it. Another man puts in here [referring to space between self-inductive lines L L] a kind of gap -- he gets a Nobel prize for doing it. My name is not mentioned. Still another man inserts here [conductor B] a mercury[-arc] rectifier. That is my friend Cooper Hewitt. But, as a matter of fact, those devices have nothing to do with the performance.

If these men knew what I do, they would not touch my arrangements; they would leave my apparatus as it is. Marconi puts in here [break D] two wheels. I showed only one wheel; he shows two. And he says, "See what happens when the wheels are rotated; a wonderful thing happens!" What is the wonderful thing? Why, when the teeth of the wheels pass one another, the currents are broken and interrupted. That is the wonderful thing that happens? The Lord himself could not make anything else happen unless he broke his own laws.

So, in this way, invention has been degraded, debased, prostituted, more in connection with my apparatus than in anything else. Not a vestige of invention as a creative effort is in the thousands of arrangements that you see under the name of other people -- not a vestige of invention. It is exactly like in car couplings on which 6,000 patents have been taken out; but all the couplings are constructed and operated exactly the same way. The inventive effort involved is about the same as that of which a 30-year-old mule is capable. **This is a fact.**

This is one of most beautiful things ever produced in the way of apparatus: I take a generator of any kind. With the generator I charge a condenser. Then I discharge the condenser under conditions which result in the production of vibrations. Now, it was known since Lord Kelvin that the condenser discharge would give this vibration, but I perfected my apparatus to such a degree that it became an instrument utilizable in the arts, in a much broader way than Lord Kelvin had contemplated as possible. In fact, years afterwards when Lord Kelvin honored me by presenting to the British Association one of my oscillators of a perfected form, he said that it was "a wonderful development and destined to be of

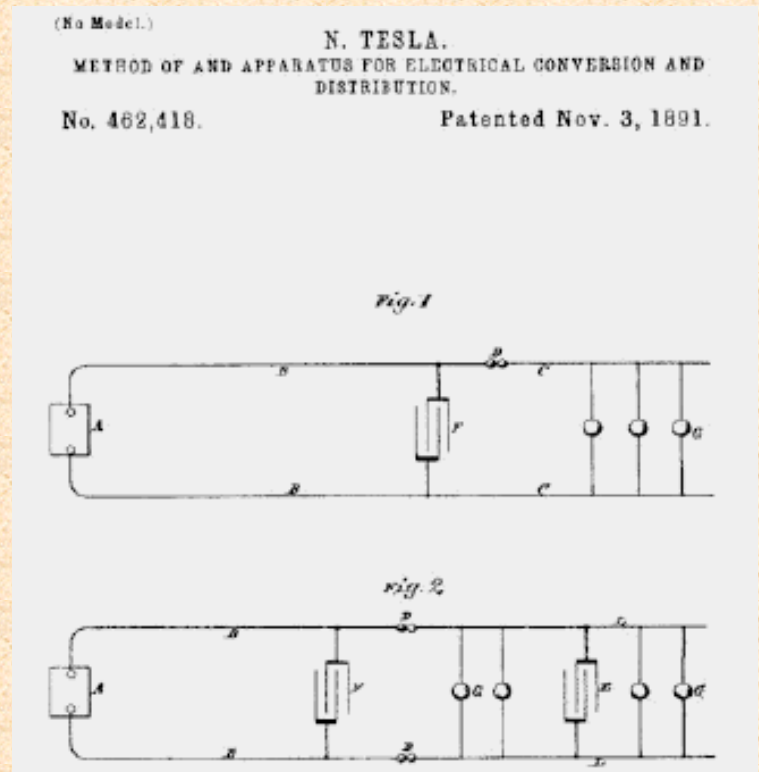

Figure 31.

Method of Transformation of electrical energy by oscillatory condenser discharges described in U.S. Patent No. 462,418 of November 3, 1891. Application filed February 4, 1891. Announcement of this invention was made in Tesla's lecture before the American Institute of Electrical Engineers at Columbia College, May 20, 1891, where it was predicted that this apparatus afforded vast possibilities and would play an important part in the future. Illustrated and described in T.C Martin book, Figs. 126 and 127, pp. 191-194.

great importance."

[Returning to a discussion of Fig. 31] It [E] is supposed to be a condenser. That [A] is the generator. Now then, supposing that this is a generator of steady pressure. I can obtain oscillations of any frequency I desire. I can make them damped or undamped. I can make them of one direction or alternating in direction as I choose. At G are devices which operate -- lamps, or anything else. Some experimenters who have gone after me have found a difficulty. They said, "No, we cannot produce a constant train of oscillations."

Well, it is not my fault. I never have had the slightest difficulty. I produced constant oscillations and I have described how I produced them. Anyone who has no more than my own skill can do it. This **[Fig. 32]** is another improvement in that particular device, which was the weakness of the invention and which I tried to eliminate.

This device incorporated many spark gaps in series. It had a peculiar feature; namely, through the great number of gaps, I was able, as I have pointed out in my writings, to produce oscillations without even a spark being visible between the knobs. This device is now known in the art as the "quenched spark gap." Professor Wein has formulated a beautiful theory about it, which I understand has netted him the Nobel prize. Wein's theories are admirable. The only trouble is that he has overlooked one very important fact.

It is this: If the apparatus is properly designed and operated, there is no use for the quenched gap, for the oscillations are continuous anyway. The radio men who came after me had the problem before them of making a bell sound, and they immersed it in mercury. Now, you know mercury is heavy.

When they struck their bell, the mercury did not permit it to vibrate long because it took away all the energy. I put my bell in a vacuum and make it vibrate for hours. I have designed circuits in connection with an enterprise in 1898 for transmission of energy which, once started, would vibrate three years, and even after that the oscillations could still be detected. Professor Wein's theory is very beautiful, but it really has no practical meaning. It will become useless as soon as the inefficient apparatus of the day, with antennae that radiate energy rapidly, [are] replaced by a scientifically designed oscillator which does not give out energy except when it gets up to a tremendous electromagnetic momentum.

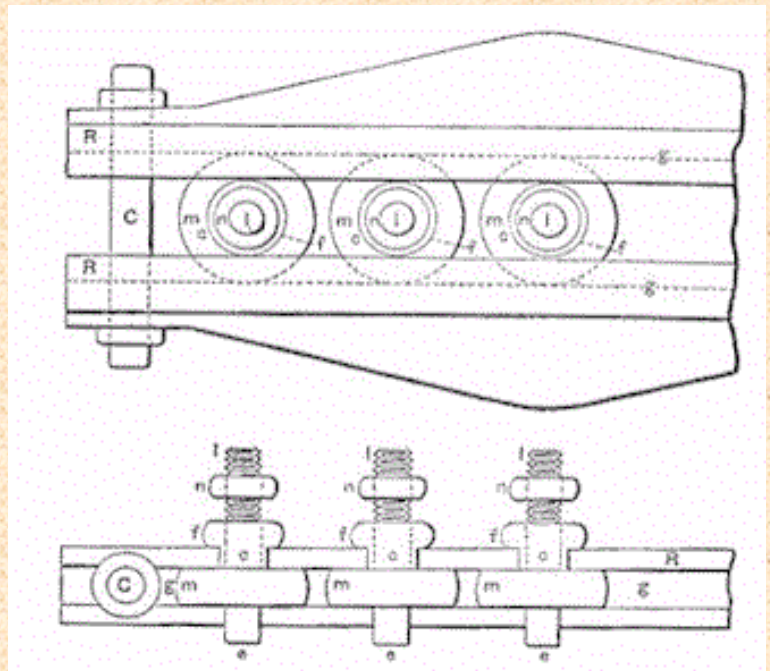

Figure 32. Quenched spark gap. (Tesla at that time pointed out the future of quenching and showed that oscillations can be maintained without a spark being visible to the naked eye between the knobs.) Illustrated in T.C. Martin book, Figs. 135 and 136, p. 211.

Figure 33. The discharger working in an atmosphere, chiefly consisting of hydrogen, still further weakened by heat. The use of hydrogen in this connection has been claimed as a discovery and patented. Presented in Tesla's lectures before the Franklin Institute and the National Electric Light Association. T.C. Martin book, Fig. 167. pp. 307-308.

In this form of break [Fig. 33], I changed the atmosphere in which the arc was operating. The atmosphere was mostly hydrogen, and with this device I performed my experiments before the Franklin Institute in Philadelphia and the National Electric Light Association in St. Louis. This has been used by Poulsen and it is now called the "Poulsen arc" and "Poulsen system." But, of course, there is no invention in it. I am on record with prior publications, and besides, the hydrogen does not have any other effect except that it lowers the tension under which the device can operate. It has the disadvantage of producing asymmetrical or distorted waves, and the impulses obtained are not best suited for tuning.

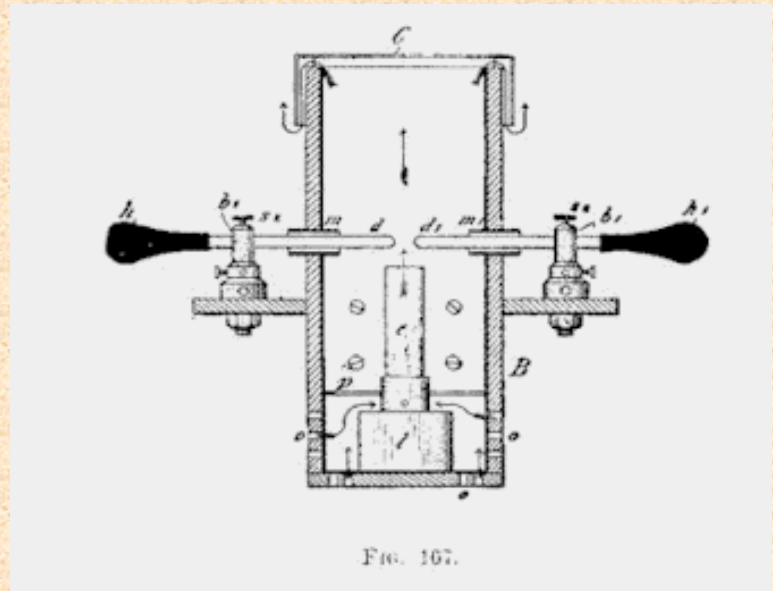

Figure 34. Oscillatory apparatus with interrupter in oil. Exhibited in the Chicago Exposition of 1893 before Helmholtz. Described in U.S. Patent No. 514,168 of February 6. 1894. Application filed August 2, 1893.

This [Fig. 34] is the apparatus used in the Chicago Exposition of 1893, at which time I explained for the first time to Professor Helmholtz my plan for transmitting energy. After I had shown Professor Helmholtz and other scientific men there certain phenomena, he asked me, "Now, what is all this intended for?" I told him I was trying to develop an apparatus for transmitting energy without wire for telegraphy, telephony, and other purposes. When I explained to Professor Helmholtz the whole idea, I said, "Excellency, do you think that my plan is realizable?" He replied, "Why, certainly it is, but first you must produce the apparatus." I started then and there to produce the apparatus.

Counsel: Was that conversation at the the Chicago Exposition?

Tesla: Yes. It took place in a pavilion which was built especially for exhibiting my inventions and discoveries. I believe Professor Wedding was there and some other scientists whom I cannot remember now. I showed Professor Helmholtz my vacuum tubes and performed many other experiments.

Counsel : Will you describe this apparatus in a little more detail?

Tesla : The apparatus [Fig. 34], as you see, comprised primary and secondary coils immersed in a large tank of oil. The break was automatically effected by means of a turbine. The oil was circulated by a pump, and the current [i.e., stream

flow] of oil drove the turbine which effected the make and break. Owing to the fact that the oil used was a very good insulator, rapidly flowing and of great dielectric strength, these make-and-break points were very close together, and the arcs extremely short. The effects were accordingly more intense. Here [T in Diag. 1 of Fig. 34] is a cooler through which the oil was circulated. The oil was forced through the gaps at great speed, and as it flowed out it was supplied again to the tank and the current driving the turbine.

Counsel : That device [Diag. 2 of Fig. 34] you call a turbine?

Tesla : Yes. It had vanes like those of a propeller and constituted a rotary break in the circuit.

Counsel : What was your prime source [of power]?

Tesla : The primary source was an alternator with a frequency of 133 cycles and, if I recollect rightly, the pressure [at the secondary] was about 20,000 volts. I may have had 10,000 volts. I am not sure what it was, but it must have been certainly from 10,000 to 20,000 volts -- within that range.

Counsel : I notice you have two sets of transformers in there marked S and S', have you not?

Tesla : This [S'] is my oscillatory circuit. That [S] is the transformer from which the condenser was charged. Here [at S] we had 20,000 volts, or whatever it was, from the commercial transformer and here [at S'] is my secondary which generated the high frequency currents. The rotary gap is shown in detail [Diag. 2 of Fig. 34].

I had a special reason for showing this. To meet that great man Helmholtz and other scientific men, and to bring before them for the first time the results of years of previous labor, was an important moment in my life -- particularly because Professor Helmholtz gave me the assurance himself that what I explained to him was realizable, provided that I could produce the apparatus. I was very much encouraged.

Figure 35. Apparatus with mechanical break as installed on a large scale in the laboratory at South Fifth Avenue and subsequently at 46 East Houston Street. Described in U.S. Patent No. 645,576 of March 20, 1900. Application filed September 2, 1897.

This [Fig. 35] is the apparatus I had at 35 South Fifth Avenue and also Houston Street. It shows the whole arrangement as I had it for the demonstration of effects which I investigated.[*] This cable you see [square loop in top half of Fig. 35] is stretched around the hall. These are my condensers. There is the mechanically operated break, and that is a transformer charged from the generator. That is the way I had it for the production of current effects which were rather of damped character because, at that period, I used circuits of great activity which radiated rapidly. In the Houston Street laboratory, I could take in my hands a coil tuned to my body and collect 3/4 horsepower anywhere in the room without tangible connection, and I have often disillusioned my visitors in regard to such wonderful effects. Sometimes, I would produce flames shooting out from my head and run a motor in my hands, or light six or eight lamps.

They could not understand these manifestations of energy and thought that it was a genuine transmission of power. I told them that these phenomena were wonderful, but that a system of

transmission, based on the same principle, was absolutely worthless. It was a transmission by electromagnetic waves. The solution lay in a different direction. I am showing you this [diagram] simply as a typical form of apparatus of that period, and if you go over the literature of the present day you will find that the newest arrangements have nothing better to show.

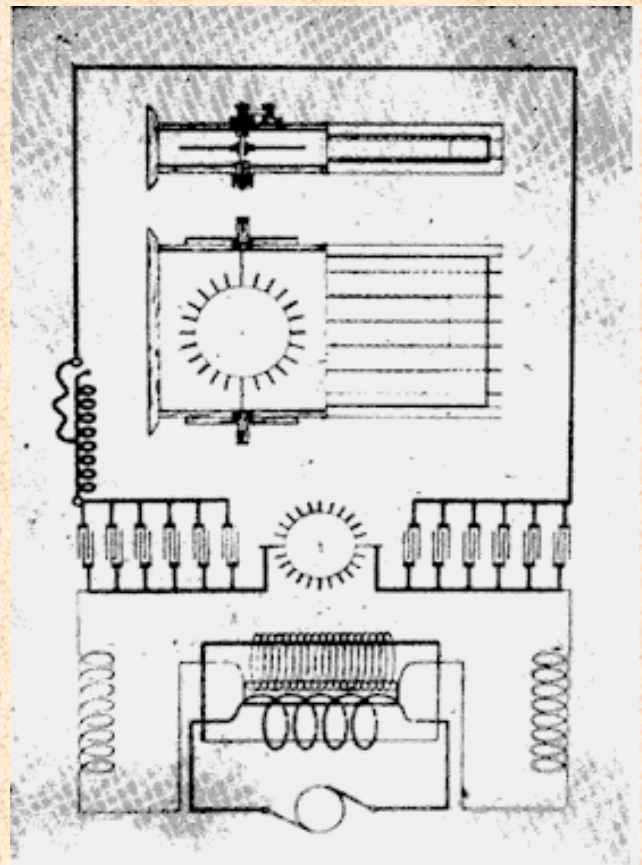

Counsel : What was the make and break frequency that you got from that apparatus?

Tesla : It was 5,000, 6,000 -- sometimes higher still. I had two oppositely rotating discs which I will show you and with which I could have reached, probably, 15,000 or 18,000.

Counsel : What wave frequencies did you develop?

Tesla : I could operate from a few thousand up to a million per second, if I wanted.

Counsel : What did you actually use?

Tesla : In these demonstrations, which I showed these effects, these most powerful effects that were the sight of New York at that time, I operated with frequencies from 30,000 to 80,000. At that time I could pick up a wire, coil it up, and tell what the vibration would be, without any test, because I was experimenting day and night.

Figure 36. Isochronous mechanical break used in the laboratory at 35 South Fifth Avenue. Described in U.S. Patent Nos. 568,179 and 568,180 of September 22, 1896. Applications filed July 6 and 9, 1896. (Diagram taken from Patent No. 568,180.)

This [Fig. 36] is a form of break which I developed in working with alternators. I recognized that it was of tremendous advantage to break at the peak of the wave. If I used just an ordinary break, it would make and break the current at low as

well as high points of the wave. Of this apparatus I had two forms; one in which I drove the break right from the shaft of the dynamo and the other in which I drove it with an isochronous motor. Then, by a movement of these knobs (K K), I would make the adjustments so that the makes would occur exactly at the top of the wave. That is a form of break which is embodied in hundreds of patents and used now extensively.

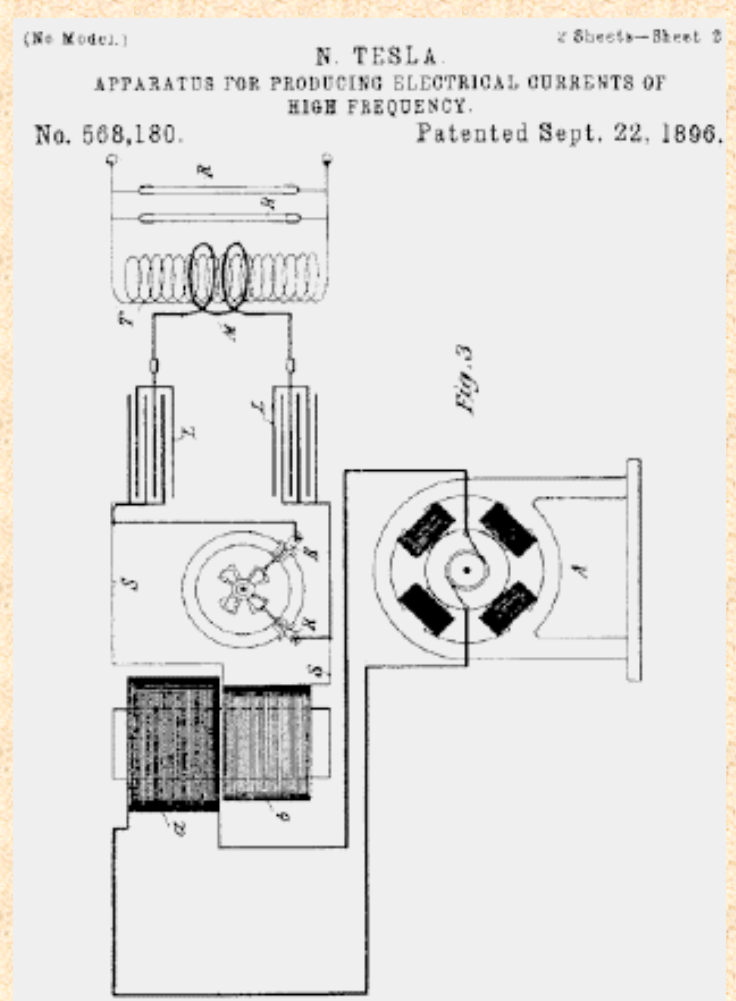
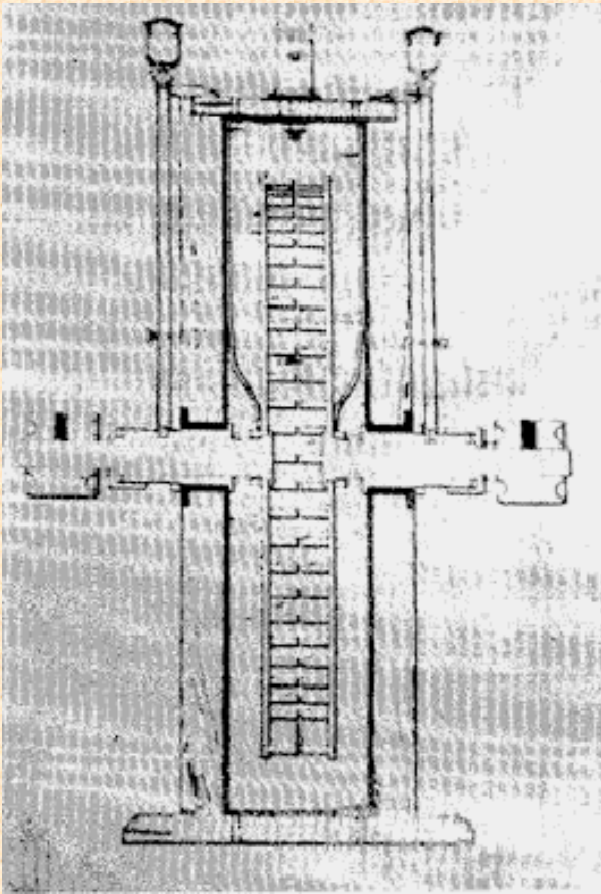

Figure 37.
Mechanical break with two oppositely rotating discs used for the purpose of increasing the number of breaks and alternating oscillations practically undamped. (Subsequently patented by others.)

Here [Fig. 37] I show an apparatus that was installed in the Houston Street laboratory prior to the other break because I wanted to get as high a number of impulses as possible. The drawing dates from the spring of 1896. It is a break with which I could reach from 15,000 to 18,000 interruptions per second. I used it very much until later I found it was not necessary. That is the innocent device which Marconi thought a great invention.

Counsel : This is also a rotary gap?



Tesla :Yes, and it consists of two discs of aluminum, with teeth of aluminum on the side. They were rotated by two motors in opposite directions, and as they rotated they alternately closed and opened the circuit. In some instances I used an uneven number of teeth on one and an even number on the other so that I could produce as many breaks as I desired. I will show you later an apparatus more perfect than this one, and of a different kind, in which I have 24 stationary contacts, and 25 rotating elements that established the contact and broke it, so that by one revolution I obtained 24 times 25, or 600 interruptions [per revolution].

Counsel : Whenever you say "the break", you mean "a spark gap"?

Tesla : Yes; otherwise I use the term "circuit controller," preferably.

This [Fig. 38] illustrates another development in a different direction. In order to increase the number of breaks, I employed currents of different phase. I had in my laboratory, permanently, a two-phase dynamo and could get phases between; that is, from two phases, 90 apart, I could obtain four phases, 45 apart. Here is an arrangement shown as I had it, working with three phases [60 apart, and could obtain six phases, 30 apart], and later on I had one with four phases [45 apart, and could obtain eight phases 22 1/2 apart]. You see, as I multiplied the number of the phases, I increased the number of the fundamental discharges.

Counsel :What is the date of this apparatus?

Tesla :This I employed already in the 35 South Fifth Avenue laboratory, because I remember that I gave entertainments to several scientific societies and it was then present there. I know on one occasion there was the Society of Architects, and another, the Electrotherapeutic Society, and then I had distinguished men like Mark Twain and Joseph Jefferson -- I gave them a demonstration which was published in Martin's article in the Century Magazine of April 1895, and I know that on these occasions I used a two-phase arrangement. Later on I made it four phase. That apparatus existed, therefore, prior to the

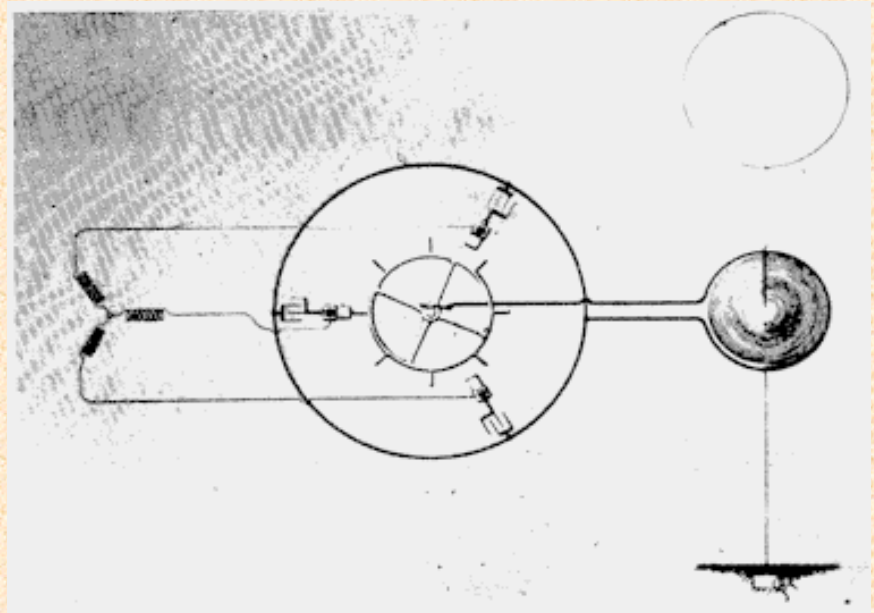

Figure 38.
Use of multi-phase generator with mechanical break.
Experiments in the laboratory at 35 South Fifth Avenue and subsequently.

destruction of my laboratory in 1895.

Counsel : Do you recall any publication in which this diagram was illustrated?

Tesla : I made no publication, and I vividly remember that when I installed my apparatus on Long Island I had an arrangement with four transformers and four phases 45 apart. After I had been using this apparatus there, several years afterwards, I ran across a patent, I believe held by the General Electric Company, describing precisely the same arrangement.[*] It was a similar experience as with that patent of Fessenden on the compressed air condenser. Any time I want to use these improvements all I need to do is to produce my records and that will settle the patents.

Counsel : When was that drawing [Fig. 38]?

Tesla : This is from an old patent drawing which was made by Mr. Netter.

Counsel : But that did not go to patent?

Tesla : No. I have hundreds of inventions that were to be patented but side-stepped. The expense was too great and I could not do it. This form of apparatus with two and four phases was used prior to the destruction of my laboratory in 1895, and it was installed on a large scale with four phases in my plant on Long Island with which I was to telephone around the world, but that is a long story.

Counsel : In that use you made of it at your laboratory, was that connected up as shown there [Fig. 38], to an antenna?

Tesla : I used the apparatus, yes, in connection with the antenna too, but this is from a patent drawing in which an antenna is shown; I mean, I used it in every connection. [Fig. 38] illustrates an antenna with my transmitting circuit, but the apparatus was used in all my work, in all my investigations.

Counsel : And when this was connected in and used in an antenna, did you use it as in other instances -- go off and listen to the notes which you received?

Tesla : Oh, certainly. But I remember that, besides this, I had different kinds of apparatus. Then I had a sensibly damped wave because at that time I still was laboring under the same difficulties as some do this day -- I had not learned how to produce a circuit which would give me, with very few fundamental impulses, a perfectly continuous wave. That came with the perfection of the devices. When I came to my experiments in Colorado, I could take my apparatus like that and get a continuous or undamped wave, almost without exception, between individual discharges.

Counsel : Speaking of your not having perfectly undamped waves at that time, you were referring to that character of circuit?

Tesla : Yes, but with another kind of circuit I could, of course. The advantage of this apparatus was the delivering of energy at short intervals whereby one could increase activity, and with this scheme I was able to perform all of those wonderful experiments which have been reprinted from time to time in the technical papers. I would take energy out of a circuit at rates of hundreds or thousands of horsepower. In Colorado, I reached 18 million horsepower activities, but that was always by this device: Energy stored in the condenser and discharged in an inconceivably small interval of time. You could not produce that activity with an undamped wave. The damped wave is of advantage because it gives you, with a generator of 1 kilowatt, an activity of 2,000, 3,000, 4,000, or 5,000 kilowatts; whereas, if you have a continuous or undamped wave, 1 kilowatt gives you only wave energy at the rate of 1 kilowatt and nothing more. That is the reason why the system with a quenched gap has become popular.

I have refined this so that I have been able to take energy out of engines by drawing on their momentum. For instance, if the engine is of 200 horsepower, I take the energy out for a minute interval of time, at a rate of 5,000 or 6,000 horsepower, then I store [it] in a condenser and discharge the same at the rate of several millions of horsepower. That is

how these wonderful effects are produced. The condenser is the most wonderful instrument, as I have stated in my writings, because it enables us to attain greater activities than are practical with explosives. There is no limit to the energy which you can develop with a condenser. There is a limit to the energy which you can develop with an explosive.

A common experiment, for instance, in my laboratory on Houston Street, was to pass through a coil energy at a rate of several thousand horsepower, put a piece of thick tinfoil on a stick, and approach it to that coil. The tinfoil would melt, and would not only melt, but while it was still in that form, it would be evaporated and the whole process took place in so small an interval of time that it was like a cannon shot. Instantly I put it there, there was an explosion. That was a striking experiment. It simply showed the power of the condenser, and at that time I was so reckless that in order to demonstrate to my visitors that my theories were correct, I would stick my head into that coil and I was not hurt; but, I would not do it now.

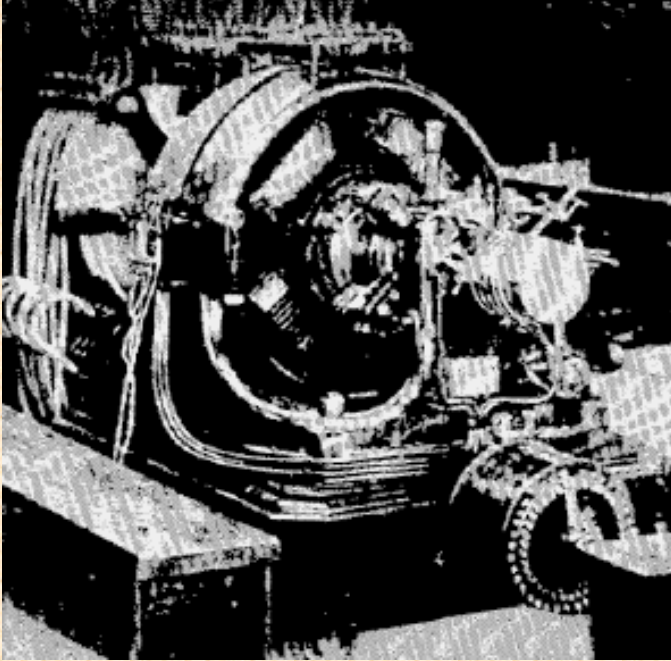

Figure 39

Apparatus furnishing direct currents of high tension, producing undamped electrical oscillations of high frequency. (This is also shown in [Fig. 27]).

Apparatus built in 1895. [Fig. 39] shows a four-phase machine which was furnished me by the Westinghouse Electric Company at the close of 1895. My laboratory burned out in May, and I urged my friend, Mr. Albert Schmidt, who was the Superintendent, to give me this alternator as soon as possible. He worked day and night until he got it out, and he certainly did notable work because while the machine was rated at 30 horsepower, I have run it at 150 horsepower.

By the way, and this is a painful reflection, it was Schmidt and I who developed this type of frame and this general arrangement which is universally adopted now -- a base, with the magnets cast below, split at the center line, and a corresponding upper part. That is now used everywhere. I remember years ago, some of my friends, Messrs. Crocker and Wheeler, started with those long magnets and I told them, "The sooner you throw these away and adopt this construction, the better it will be for you." They have got it now; it is all right.

Counsel : How is this machine [Fig. 39] shown in connection with that?

Tesla : This dynamo [Fig. 39], you see, is a two-phase machine; that is, I develop from it currents of two-phase. Now, there are four transformers. You see them down here [lower left of Fig. 39] that furnish the primary energy. From these two phases I develop four phases. [However,] this involves something else which I have referred to before; namely, an arrangement which enables me to produce from these alternating currents direct currents and undamped -- absolutely undamped -- isochronous oscillations of any period I like.

This is accomplished in the following manner: The secondaries of the four transformers could each develop 44,000 volts. They were specially built for me by the Westinghouse Company. They could, however, be connected in such a way that each would give 11,000 volts, and then I would take these 11,000 volts and these four phases and commutate them by a commutator consisting of aluminum plates, or aluminum segments, which were rotated in synchronism with the alternator. Then I obtained a continuous pressure; that is, direct current of a tension of 44,000 volts, and with these 44,000 volts I charged my condensers. Then by discharging the condensers, either through a stationary gap or through a gap with a mechanical interrupter, I obtained any frequency I desired, and perfectly undamped waves. This arrangement was installed in 1901 in my wireless plant at Long Island, with which I was to telephone around the world.

Counsel : Who built that machine?

Tesla : The Westinghouse Company, [under direction of] Mr. Albert Schmidt, Superintendent. It was especially built for me and furnished to my laboratory on Houston Street. While I was with the Westinghouse Company, I did two things in addition to bringing my motors to them. I had discovered that Bessemer steel was a much better material for transformers and motors than the soft iron which was previously used. When I came to Pittsburgh, my motors gave results which their motors could not at first produce, and I told them that I had used Bessemer steel. I discovered, in following up the analysis of the steels which were used, that the Bessemer was not steel but really soft iron. The Westinghouse people then adopted my suggestion. At first, Mr. Shallenberger and other electricians there objected very much, but I persuaded them and when the transformers were built we found that we could get 2 1/2 times the output we got before.

The Westinghouse people kept it a secret for a long time and no one understood how they could make such fine transformers, but all they did was to use the Bessemer steel, on my suggestion, instead of the soft iron the General Electric and other people used. Mr. Westinghouse especially requested me to join efforts with Mr. Schmidt and improve the design of his machines, and we did so. We evolved this design, introduced the ready-made coils, which are pressed on the armature, and other improvements. I took a couple of patents out with Mr. Schmidt, and Mr. Westinghouse was very nice about it. I think he compensated me with \$10,000, or something like that, for my suggestions.

Counsel : You have spoken of the use of that machine at Houston Street. In what way was it used?

Tesla : I used this machine, as I said, either to produce alternating currents and then interrupt them with a mechanical break at the high peaks of the wave; or, I used alternating currents and interrupted them with an independent rotating break having a great number of teeth. Or, I generated continuous currents by commutating the high tension alternating currents of the transformer. At that time I had two transformers from which I obtained a constant pressure, charged the condenser, and produced undamped waves of any frequency I wanted. As to the machine here [Fig. 39], that is the way it was arranged. It was for the generation of continuous electromotive force and production of undamped waves -- from 1895 and on.

Counsel : What sort of apparatus was it connected up to for the purpose of absorbing these waves?

Tesla : It was the same as shown here [Fig. 38]. It was connected to the condensers, and these condensers were discharged through a primary which excited the secondary; the antenna was included in the secondary. At other times we discharged the condensers directly so that I could use the antenna without the secondary.

Counsel : In the same way did you note the operation of these waves?

Tesla : We did, of course, only in most cases the instrument of reception was different. When I operated with these continuous, or undamped, waves, generated in this way, I usually went to high frequencies. I did operate [at] a very few thousand, but that gave me a smaller output. Such a machine you have to operate at high frequencies to get power.

Counsel : What do you mean by high frequencies?

Tesla : I mean frequencies of 30,000, 40,000, 50,000, or something like that.

Counsel : And by means of that machine, you put undamped waves of frequency about 50,000 into that antenna at Houston Street in 1895?

Tesla : No, not in 1895. Late in 1895 the machine was furnished and I began to operate in early 1896. That is when I began to operate.

Counsel : Then you did this, that I speak of, in 1896?

Tesla : Yes, from 1896 to 1899, right along.

Counsel : When you used frequencies like that in your antenna, was your antenna tuned or untuned?

Tesla : I could not use it untuned. That would be absurd.

Counsel : What form of device did you use, and where did you use it, for noting the generation of these oscillations or waves in the antenna?

Tesla : I suppose I had hundreds of devices, but the first device that I used, and it was very successful, was an improvement on the bolometer. I met Professor Langley in 1892 at the Royal Institution. He said to me, after I had delivered a lecture, that they were all proud of me. I spoke to him of the bolometer, and remarked that it was a beautiful instrument. I then said, "Professor Langley, I have a suggestion for making an improvement in the bolometer, if you will embody it in the principle." I explained to him how the bolometer could be improved. Professor Langley was very much interested and wrote in his notebook what I suggested. I used what I have termed a small-mass resistance, but of much smaller mass than in the bolometer of Langley, and of much smaller mass than that of any of the devices which have been recorded in patents issued since. Those are clumsy things. I used masses that were not a millionth of the smallest mass described in any of the patents, or in the publications. With such an instrument, I operated, for instance, in West Point -- I received signals from my laboratory on Houston Street in West Point.

Counsel : This was then the machine that you used when working with West Point?

Tesla : I operated once or twice with it at that distance, but usually as I was investigating in the city. My work at that time was to prepare for the development of a commercial plant, and with me the question was not to transmit signals, but to see what intensity I could get to put me in position to calculate out my apparatus, the dimensions and the forms, before I began the undertaking. It was nothing but preparatory work for the construction of a commercial plant, and I demonstrated its practicability through my experiments, a plant which was to accomplish much more than all others.

Counsel : What was the horsepower activity in the oscillating circuits when you used this machine?

Tesla : Usually something like 50 horsepower, and I would get, I should say, approximately 30 horsepower in the antenna; that is, I would get 30 horsepower in the oscillating circuit.

Counsel : I understood a little while ago when you made the statement of using several thousand horsepower put into a condenser, you could take out of the condenser a million horsepower. I wondered if you got the same condition with this machine.

Tesla : Yes; I charged the condenser with 40,000 volts. When it was charged full, I discharged it suddenly, through a short circuit which gave me a very rapid rate of oscillation. Let us suppose that I had stored in the condenser 10 watts. Then, for such a wave there is a flux of energy of $(4 \times 10^4)^2$, and this is multiplied by the frequency of 100,000. You see, it may go into thousands or millions of horsepower.

Counsel : What I wanted to get at was, did that depend upon the suddenness of the discharge?

Tesla : Yes. It is merely the electrical analogue of a pile driver or a hammer. You accumulate energy through a long distance and then you deliver it with a tremendous suddenness. The distance through which the mass moves is small -- the pressure immense.

Counsel : Did you find that that was the best condition for transmitting energy without the use of wire?

Tesla : No, I did not use that method when I was transmitting energy. I used it only in the production of those freaks for which I have been called a magician. If I had used merely undamped waves, I would have been an ordinary electrician like everybody else.

Counsel : You have referred to some delicate receiving instruments. Did you have any trouble with those burning out on account of static?

Tesla : My dear sir, I burned out so many instruments before I discovered what was the matter with them! They burned out instantly until I learned how to make them so that they could not burn out. Yes, that was a great trouble in the beginning.

Counsel : Did you succeed in getting them so they would not burn out?

Tesla : Yes. If lightning struck close by, it would not burn out my instrument that has a millionth of the smallest mass used in the instruments of others.

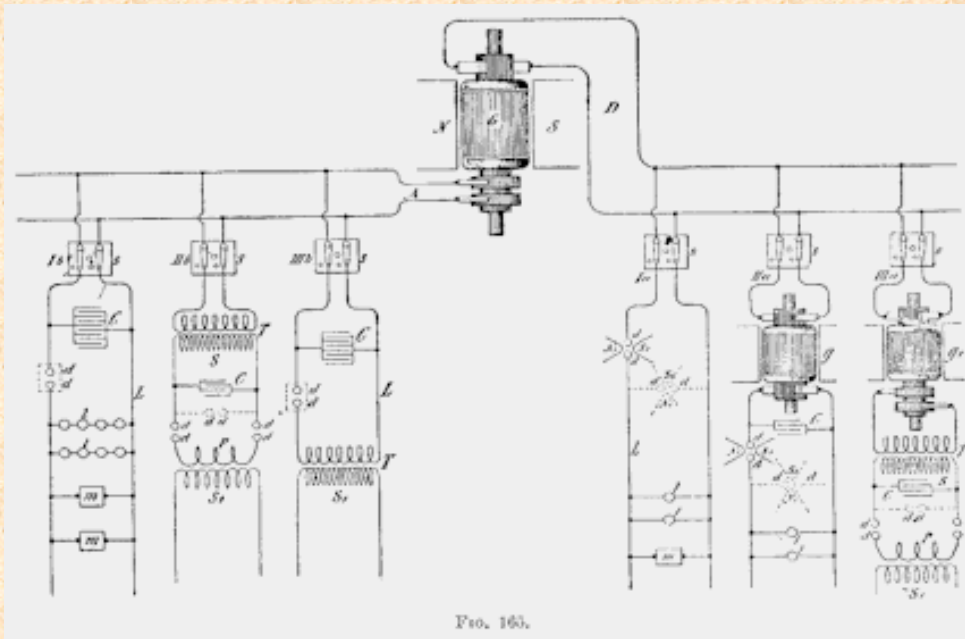
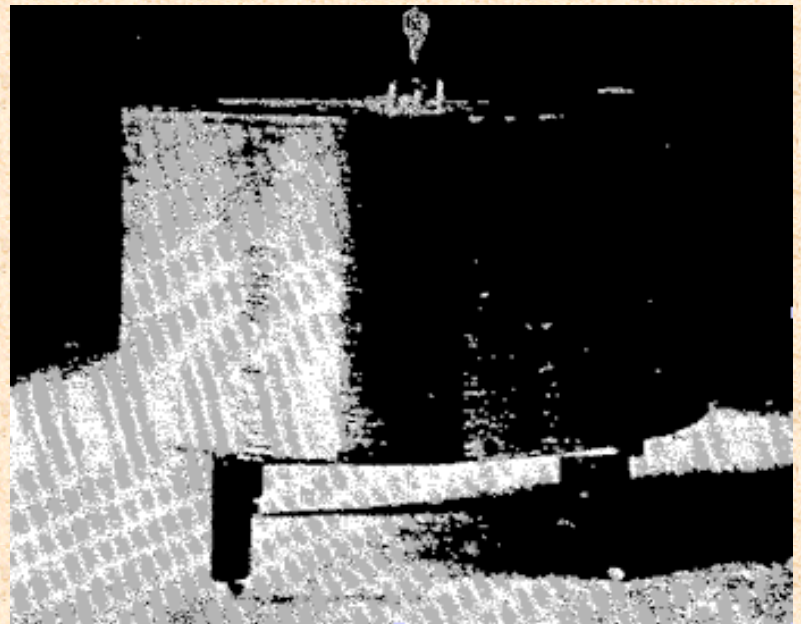

Figure 40. Apparatus and method of conversion by condenser discharges applicable to both alternating and direct currents. Described in lectures before the Franklin Institute and the National Electric Light association early in 1893. Illustrated in T.C. Martin book, Fig. 165, pp. 302-317.

This [Fig. 40] is a systematic representation of the various ways which I gave in my lecture before the Franklin Institute and the National Electric Light Association, embodying the general arrangements for the obtaining of continuous waves, undamped or damped waves, from direct and alternating current supply. On the one side [right] you have direct, on the other side alternating current supply. Some electricians have had difficulties in operating some of this apparatus. I had none.

I can take an ordinary circuit of 50 volts and produce from it absolutely undamped oscillations and never have the slightest difficulty about it.

Figure 41.
Illustrating one of the early experiments with a tuned transformer in the laboratory at South Fifth Avenue.
Now I come to a few pieces of apparatus which I used in the Houston Street laboratory and the South Fifth Avenue laboratory. I have here [Fig. 41] what you might call a tuning coil. I employed usually another secondary and had my condensers on the table. You see one of the coils in action. This is a tuned circuit which responds to electromagnetic waves which are sent through the room.



Counsel : This is being used as a receiver of waves?

Tesla : Yes.

Figure 42. Another illustration of one of the early experiments with a tuned transformer in the laboratory at South Fifth Avenue. (Article by T.C. Martin ["Tesla's Oscillator and Other Inventions"], Century Magazine, April 1895, Fig. 9, p. 926.)

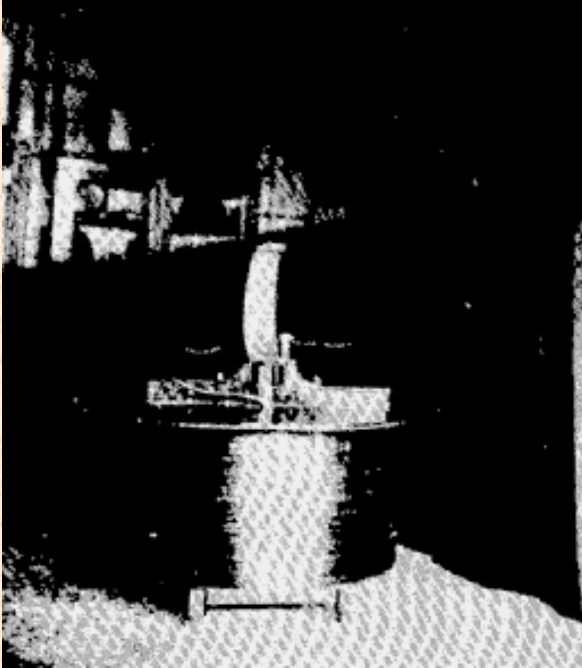

This [instrument shown in Fig. 42] was used in the laboratory on South Fifth Avenue. Here [large circular disc lying on top of coil] is the tuning table with the condensers, a thick primary, and another secondary wire. Sometimes I would operate with two vibrations and I would tune the first circuit to one and the second to the other. Here [referring to cabinets in back of room] you see some of my historical apparatus. Professor Fairfield Osborn[*] came once to my laboratory and said to me, "Why on earth do you keep it in this laboratory?" I had all of this apparatus, 400 pieces, absolutely priceless, and he offered to take it over to the Museum. But I did not heed his advice, and it is gone.

Counsel : Where were the waves sent from?

Tesla : The whole room was energized by electromagnetic waves and the receiver responded at any place in the hall. The hall was bigger than this room [shown in Fig. 42], twice as long, and anywhere the intensity of action was the same. These discs [vertical, on top of tuning table] were, I think, about 14 or 15 inches in diameter, and you could see the streamers [shown as white between the discs] anywhere in the room. In a hall twice as long as this, wherever I placed the instrument, it would respond to the electromagnetic waves.

Counsel : In this particular instance you are speaking of, the waves were generated right there at 35 South Fifth Avenue?

Tesla : Yes.

Counsel : Was that the apparatus in which you had the primaries running entirely around the room?

Tesla : Yes. This was shown to many people and societies. This [Fig. 43] shows the first single step I made toward the evolution of an apparatus which, given primary oscillations, will transform them into oscillations capable of penetrating the medium. That experiment, which was marvelous at the time it was performed, was shown for the first time in 1894. I remember the incident perfectly. I called Mr. Edward Adams, the banker, to come and see it, and he was the first man to observe it and to hear my explanation of what it meant.

Figure 43. Apparatus in action illustrating the first step in the evolution of the magnifying transmitter in the laboratory at 35 South Fifth Avenue. (Article by T.C. Martin ["Tesla's Oscillator and Other Inventions"], Century Magazine, April 1895, Fig. 15, p. 932.)

This coil, which I have subsequently shown in my patents Nos. 645,576 and 649,621, in the form of a spiral, was, as you see, [earlier] in the form of a cone. The idea was to put the coil, with reference to the primary, in an inductive connection which was not close -- we call it now a loose



coupling -- but free to permit a great resonant rise. That was the first single step, as I say, toward the evolution of an invention which I have called my "magnifying transmitter." That means, a circuit connected to ground and to the antenna, of a tremendous electromagnetic momentum and small damping factor, with all the conditions so determined that an immense accumulation of electrical energy can take place. It was along this line that I finally arrived at the results described in my article in the Century Magazine of June 1900. [Fig. 43] shows an alternator; not the alternator that was furnished for my laboratory on Houston Street -- that was another one, [but] at 35 South Fifth Avenue [and] operated on the same principle. Here [lower left] are the condensers, primary, and all the rest. The discharge there was 5 or 6 feet, comparatively small to what I subsequently obtained. I have produced discharges of 100 feet, and could produce some of 1,000 feet if necessary, with the greatest facility.

Counsel : Mr. Tesla, at that point, what did you mean by electro-magnetic momentum?

Tesla : I mean that you have to have in the circuit, inertia. You have to have a large self-inductance in order that you may accomplish two things: First, a comparatively low frequency, which will reduce the radiation of the electromagnetic waves to a comparatively small value, and second, a great resonant effect. That is not possible in an antenna, for instance, of large capacity and small self-inductance. A large capacity and small self-inductance is the poorest kind of circuit which can be constructed; it gives a very small resonant effect. That was the reason why in my experiments in Colorado the energies were 1,000 times greater than in the present antennae.

Counsel : You say the energy was 1,000 times greater. Do you mean that the voltage was increased, or the current, or both?

Tesla : Yes [both]. To be more explicit, I take a very large self-inductance and a comparatively small capacity, which I have constructed in a certain way so that the electricity cannot leak out. I thus obtain a low frequency; but, as you know, the electromagnetic radiation is proportionate to the square root of the capacity divided by the self-induction. I do not permit the energy to go out; I accumulate in that circuit a tremendous energy. When the high potential is attained, if I want to give off electromagnetic waves, I do so, but I prefer to reduce those waves in quantity and pass a current into the earth, because electromagnetic wave energy is not recoverable while that [earth] current is entirely recoverable, being the energy stored in an elastic system.

Counsel : What elastic system do you refer to?

Tesla : I mean this: If you pass a current into a circuit with large self-induction, and no radiation takes place, and you have a low resistance, there is no possibility of this energy getting out into space; therefore, the impressed impulses accumulate.

Counsel : Let's see if I understand this correctly. If you have radiation or electromagnetic waves going from your system, the energy is wasted?

Tesla : Absolutely wasted. From my circuit you can get either electromagnetic waves, 90 percent of electromagnetic waves if you like, and 10 percent in the current energy that passes through the earth. Or, you can reverse the process and get 10 percent of the energy in electromagnetic waves and 90 percent in energy of the current that passes through the earth. It is just like this: I have invented a knife. The knife can cut with the sharp edge. I tell the man who applies my

invention, you must cut with the sharp edge. I know perfectly well you can cut butter with the blunt edge, but my knife is not intended for this. You must not make the antenna give off 90 percent in electromagnetic and 10 percent in current waves, because the electromagnetic waves are lost by the time you are a few arcs around the planet, while the current travels to the uttermost distance of the globe and can be recovered.

This view, by the way, is now confirmed. Note, for instance, the mathematical treatise of Sommerfeld,[*] who shows that my theory is correct, that I was right in my explanations of the phenomena, and that the profession was completely misled. This is the reason why these followers of mine in high frequency currents have made a mistake. They wanted to make high frequency alternators of 200,000 cycles with the idea that they would produce electromagnetic waves, 90 percent in electromagnetic waves and the rest in current energy.

I only used low alternations, and I produced 90 percent in current energy and only 10 percent in electromagnetic waves, which are wasted, and that is why I got my results. . . . You see, the apparatus which I have devised was an apparatus enabling one to produce tremendous differences of potential and currents in an antenna circuit. These requirements must be fulfilled, whether you transmit by currents of conduction, or whether you transmit by electromagnetic waves. You want high potential currents, you want a great amount of vibratory energy; but you can graduate this vibratory energy.

By proper design and choice of wave lengths, you can arrange it so that you get, for instance, 5 percent in these electromagnetic waves and 95 percent in the current that goes through the earth. That is what I am doing. Or you can get, as these radio men, 95 percent in the energy of electromagnetic waves and only 5 percent in the energy of the current. . . . The apparatus is suitable for one or the other method. I am not producing radiation with my system; I am suppressing electromagnetic waves. ... In my system, you should free yourself of the idea that there is radiation, that the energy is radiated. It is not radiated; it is conserved. . . .

Tesla's "Magnifying Transmitter"

Article: "The New York Times"...27 March, 1904

To gather in the latent electricity in the clouds and with the globe itself as a medium of transmission to convey telegraphic messages, power for commercial purposes, or even the sound of the human voice to the utmost confines of the earth is the latest dream of Nikola Tesla. In an article which appeared recently in The Electrical World Mr. Tesla explains the theories on which the world telegraphy system is founded and what he expects to accomplish by it.

His plans involve the establishment of stations for the transmission of messages and power, "preferably near important centers of civilization." Oddly enough, what Mr. Tesla proudly designates as the first of his commercial "world telegraphy" stations has been established at Wardencllyffe, Shoreham, Long Island, New York, which is not in any sense an important "centre of civilization," but a place described by train hands of the Long Island Railroad as a way station where "a passenger alights occasionally."

Tesla's "Magnifying Transmitter", at Wardencllyffe, Shoreham, LI (New York). The transmitting station is an octagonal tower, pyramidal in shape, and some 187 feet in height. It consists of huge wooden stilts, heavily braced, and reinforced, and surmounted by a cupola of interlaced steel wires, bent so as to form an arc. In the cupola there is a wooden platform occupying its entire width. Mr. Tesla began work on his transmitting station about eighteen months ago.



When he first came there, and it was understood that J. Pierpont Morgan had become interested in his odd enterprise and furnished him with financial assistance, a thrill of vague expectancy ran through the little settlement, The Wardencllyffe Land Company, which owns practically all the available ground in the vicinity, gave the inventor a free grant of some 175 acres of fine land, and then settled down to wait for the day when Wardencllyffe would become the centre of the universe.

Some of the farmers who come to Wardencllyffe to send their products to this city look at Mr. Tesla's tower, which is situated directly opposite the railroad station, and shake their heads sadly. They are inclined to take a skeptical view regarding the feasibility of the wireless "world telegraphy" idea, but yet Tesla's transmitting tower as it stands in lonely grandeur and boldly silhouetted against the sky on a wide clearing on the concession is a source of great satisfaction and of some mystification to them all.

"It is a mighty fine tower," said one food farmer to a visitor last week. "The breeze up there is something grand on a Summer evening, and you can see the Sound and all the steamers that go by. We are tired, though, trying to figure out why he put it here instead of at Coney Island. " While the tower itself is very "stagy" and picturesque, it is the wonders that are supposed to be hidden in the earth underneath it that excite the curiosity of the population in the little settlement.

In the centre of the wide concrete platform which serves as a base for the structure there is a wooden affair very much like the companionway on an ocean steamer. The tower and the enclosure in which it has been built are being carefully guarded these days, and no one except Mr. Tesla's own men are allowed to approach it. Only they have been allowed as much as the briefest peep down the companionway. Mr. Scherff, the private secretary of the inventor, told an inquirer that the companionway led to a small drainage passage built for the purpose of keeping the ground about the tower dry.

But such of the villagers as saw the tower constructed tell a different story. They declare that it leads to a well-like excavation as deep as the tower is high with walls of mason work and a circular stairway leading to the bottom.

From there, they say, tunnels have been built in all directions, until the entire ground below the little plain on which the tower is raised has been honeycombed with subterranean passages.

They tell with awe how Mr. Tesla, on his weekly visits to Wardenclyffe, spends as much time in the underground passages as he does on the tower or in the handsome laboratory and workshop erected beside it, and where the power plant for the world telegraph has been installed.



No instruments have been installed as yet in the transmitter, nor has Mr. Tesla given any description of what they will be like. But in his article he announces that he will transmit from the tower an electric wave of a total maximum activity of ten million horse power. This, he says, will be possible with a plant of but 100 horse power, by the use of a magnifying transmitter of his own invention and certain artifices which he promises to make known in due course. What he expects to accomplish is summed up in the closing paragraph as follows:

"When the great truth, accidentally revealed and experimentally confirmed, is fully recognized, that this planet, with all its appalling immensity, is to electric currents virtually no more than a small metal ball and that by virtue of this fact many possibilities, each baffling imagination and of incalculable consequence, are rendered absolutely sure of accomplishment; when the first plant is inaugurated and it is shown that a telegraphic message, almost as secret and non-interferable as a thought, can be transmitted to any terrestrial distance, the sound of the human voice, with all its intonations and inflections faithfully and instantly reproduced at any other point of the globe, the energy of a waterfall made available for supplying light, heat or motive power, anywhere...on sea, or land, or high in the air...humanity will be like an ant heap stirred up with a stick. See the excitement coming!" "Cloud born Electric Wavelets To Encircle the Globe: This Is Nicola Tesla's Latest Dream, and the Long Island Hamlet of Wardenclyffe Marvels Thereat," New York Times, 27 March 1904.

Let's continue:

As a young man, Nikola Tesla talked often of the possibility of interplanetary communication. Influenced by Buddhist philosophy and the thinking of Ernst Mach, Tesla began to develop a cosmology that tried to get at the heart of what life was and simultaneously discover electricity's role in the process. He believed in the concept of an all-pervasive aether and also believed that machines could be developed that would have the capability of thinking for themselves.

"The Problem of Increasing Human Energy", which was published 100 years ago (as of June 2000) in Century Magazine spells out Tesla's thoughts and visions for the future of mankind. This was written at the pinnacle of Tesla's life, when he was full of vigor, fresh from his startling accomplishments with the complete victory of his alternating current system over Edison's direct current system. In a radical departure from his previous writings which were of a technical nature, Tesla reveals his philosophy and hopes for humankind. In the article, Tesla expressed his belief that all of us are responsible for increasing the human mass, morally, intellectually, and physically. It was a radical article then... and in some circles... still be considered radical. Nonetheless it caught the eye of JP Morgan who financed Tesla's biggest dream... and most devastating disappointment.. Wardencllyffe! With the tower he had planned for the site, Tesla was going to power the world and light the oceans...A Fascinating Vision... However, powerful economic roadblocks stood in the way that drove Tesla deep into bankruptcy and culminated in the mindless destruction of the tower at Wardencllyffe.

CREDIT: The Electrical Experimenter, Dec. 1917.

Tesla's World Of Tomorrow

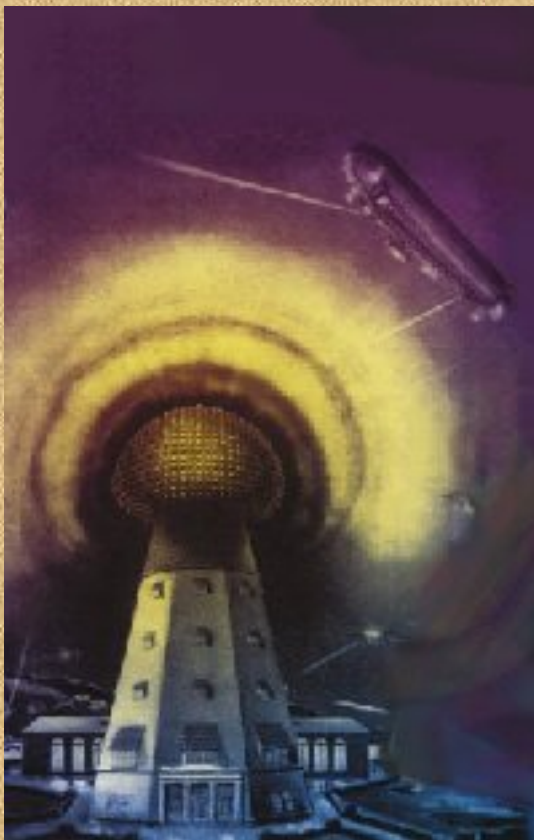

Tesla's life changed dramatically after Wardencllyffe. Initially his focus was on developing his bladeless turbine; but always his thoughts turned towards the revival of Wardencllyffe and his beloved Magnifying Transmitter. In 1925, his ideas on the wireless transmission of power were briefly entertained by the Bureau of Standards, but were abruptly rejected out of hand... due to the ignorance of how Tesla's system worked.

As an elderly man, Tesla discussed controversial topics such as free energy, particle beam weapons, cosmic rays that travel faster than light speed, a new magnifying transmitter which could harness these cosmic rays, interplanetary communication and also the claim that he could transmit energy at twice the speed of light. The identification of each separate invention became a somewhat confusing task for journalists and researchers because each of these ideas involve the transmission of energy to distant places: and the so called "death ray" apparently, in its final form, comprised features from some, if not all of the other inventions above.

It is these exotic inventions that interest and fuels the free energy researchers imagination. It was Tesla's claim that he could transmit energy at twice the speed of light that brought Tesla in direct conflict with Einstein's suggestion that space was curved--the conventional mode of thought at the

time. Tesla's unique views on the nature of radioactivity also placed him out of the mainstream scientific world. Was Tesla simply delusional ... or did he indeed have a keen insight into the wheel work of Nature? Time will tell.

Tesla's World of Tomorrow :

- We are on the threshold of a gigantic revolution, based on the commercialization of the wireless transmission of power.**
- Motion pictures will be flashed across limitless spaces.**
- The same energy (wireless transmission of power) will drive airplanes and dirigibles from one central base.**
- In rocket-propelled machines... it will be practicable to attain speeds of nearly a mile a second (3600 m.p.h.) through the rarefied medium above the stratosphere.**
- I have fame and untold wealth, more than this, and yet, how many articles have been written in which I was declared to be an impractical unsuccessful man, and how many poor, struggling writers have called me a visionary. Such is the folly and shortsightedness of the world! Nikola Tesla**
- We will be enabled to illuminate the whole sky at night...Eventually we will flash power in virtually unlimited amounts to planets... Nikola Tesla.**

CREDIT: The Electrical Experimenter, Dec. 1917.

[NEXT](#)

[BACK](#)

[INDEX](#)

THE WIRELESS TRANSMISSION OF ELECTRICAL POWER



It is possible that Nikola Tesla is best known for his remarkable statements regarding the wireless transmission of electrical power. His first efforts towards this end started in 1891 and were intended to simply "disturb the electrical equilibrium in the nearby portions of the earth... to bring into operation in any way some instrument." In other words the object of his experiments was simply to produce effects locally and detect them at a distance.

By 1899 the electrical potential of his transmitter had increased to the point that more room was needed for the sake of safety. This and other considerations led him to temporarily shift his wireless experiments to a location just outside of Colorado Springs. At this Colorado "Experimental Station" Tesla had some early success in wireless power transmission.

One photograph shows that "a small incandescent lamp was lighted by means of a resonant circuit grounded on one end, all the energy being drawn through the earth [from a nearby transmitter]."

In 1907 he even went as far as to make this statement: "... to make the little filament glow, the entire surface of the planet, two hundred million square miles, must be strongly electrified. This calls for peculiar electrical activities, hundreds of times greater than those involved in the lighting of an arc lamp through the human body [a far more spectacular demonstration]. What impresses him most, however, is the knowledge that the little lamp will spring into the same brilliancy anywhere on the globe, there being no appreciable diminution of the effect with the increase of distance from the transmitter." (One of Tesla's favorite pictures of himself- above, Left)

It is not at all clear that Tesla was referring to effects produced by his large Colorado transmitter. It is quite possible that he was writing about what could be done with an even bigger transmitter such as the one that he was developing in New York. If the Wardenclyffe communications facility had been finished, the 187 foot tall mushroom-shaped tower would have permanently housed a set of large coils including an immense helical resonator that would have served as the main transmitting element. Directly below the wooden tower there was a 120 foot shaft where deep underground Tesla had installed a radial array of iron pipes that served as a connection between the oscillator and the earth.

The Wardenclyffe plant was a major milestone in Tesla's researches into the application of alternating electrical currents to wireless communications and power transmission, an effort which drew a considerable amount of Tesla's attention during the period between 1891 and 1912. In the article "The

Future of the Wireless Art" which appeared in *Wireless Telegraphy & Telephony*, 1908, Tesla made the following statement regarding the Wardenclyffe project on which he was then working: "As soon as completed, it will be possible for a business man in New York to dictate instructions, and have them instantly appear in type at his office in London or elsewhere. He will be able to call up, from his desk, and talk to any telephone subscriber on the globe, without any change whatever in the existing equipment. An inexpensive instrument, not bigger than a watch, will enable its bearer to hear anywhere, on sea or land, music or song, the speech of a political leader, the address of an eminent man of science, or the sermon of an eloquent clergyman, delivered in some other place, however distant.

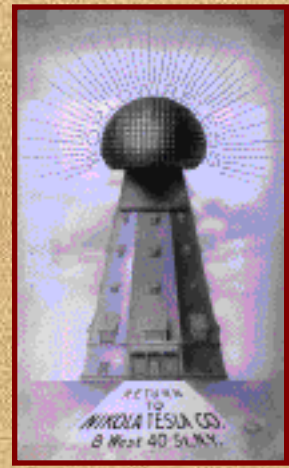

In the same manner any picture, character, drawing, or print can be transferred from one to another place. Millions of such instruments can be operated from but one plant of this kind. More important than this, however, will be the transmission of power, without wires, which will be shown on a scale large enough to carry conviction.

These few indications will be sufficient to show that the wireless art offers greater possibilities than any invention or discovery heretofore made, and if the conditions are favorable, we can expect with certitude that in the next few years wonders will be wrought by its application."

In the end, Tesla was never able to complete the Wardenclyffe plant, although he was able to conduct some performance tests. Nevertheless, if the above stated predictions were to be true, an interesting feature of Tesla's World System for global communications, had it gone into full operation, would have been its capacity to provide small but usable quantities of electrical power at the location of the receiving circuits.

A MUSEUM AT WARDENCLYFFE - THE CREATION OF A MONUMENT TO NIKOLA TESLA

The year was 1900 and following 9 productive months of wireless propagation research in Colorado, Nikola Tesla was anxious to put a mass of new found knowledge to work. His vision focused on the development of a prototype wireless communications station and research facility and he needed a site on which to build. In 1901 he cast his eyes some 60 miles eastward to the north shore village of Woodville Landing. Only six years before the north branch of the Long Island Railroad had opened, reducing travel time to the locality from a horse drawn five hours to less than two. Seeing an opportunity in land development a western lawyer and banker by the name of James S. Warden had purchased 1400 acres in the area and started building an exclusive summer resort community known as Wardenclyffe-On-Sound. With an opportunity for further development in mind, Warden offered Tesla a 200 acre section of this parcel lying directly to the south of the newly laid track. It was anticipated that implementation of Tesla's system would eventually lead to the establishment of a "Radio City" to house the thousands of employees needed for operation of the facility. The proximity to Manhattan and the fairly short travel time between the two, along with the site's closeness to a railway line must surely have been attractive features and Tesla accepted the offer.

The Wardenclyffe World Wireless facility as envisioned by Tesla was to have been quite different from

present day radio broadcasting stations. While there was to be a great similarity in the apparatus employed, the method in which it was to be utilized would have been radically different. Conventional transmitters are designed so as to maximize the amount of power radiated from the antenna structure. Such equipment must process tremendous amounts of power in order to counteract the loss in field strength encountered as the signal radiates out from its point of origin. The transmitter at Wardenclyffe was being configured so as to minimize the radiated power. The energy of Tesla's steam driven Westinghouse 200 kW alternator was to be channeled instead into an extensive underground radial structure of iron pipe installed 120 feet beneath the tower's base. This was to be accomplished by superposing a low frequency baseband signal on the higher frequency signal coursing through the transmitter's helical resonator. The low frequency current in the presence of an enveloping corona-induced plasma of free charge carriers would have pumped the earth's charge. It is believed the resulting ground current and its associated wave complex would have allowed the propagation of wireless transmissions to any distance on the earth's surface with as little as 5% loss due to radiation. The terrestrial transmission line modes so excited would have supported a system with the following technical capabilities:

1. Establishment of a multi-channel global broadcasting system with programming including news, music, etc;
2. Interconnection of the world's telephone and telegraph exchanges, and stock tickers;
3. Transmission of written and printed matter, and data;
4. World wide reproduction of photographic images;
5. Establishment of a universal marine navigation and location system, including a means for the synchronization of precision timepieces;
6. Establishment of secure wireless communications services.

The plan was to build the first of many installations to be located near major population centers around the world. If the program had moved forward without interruption, the Long Island prototype would have been followed by additional units the first of which being built somewhere along the coast of England. By the Summer of 1902 Tesla had shifted his laboratory operations from the Houston Street Laboratory to the rural Long Island setting and work began in earnest on development of the station and furthering of the propagation research. Construction had been made possible largely through the backing of financier J. Pierpont Morgan who had offered Tesla \$150,000 towards the end of 1900. By July 1904, however, this support had run out and with a subsequent major down turn in the financial markets Tesla was compelled to pursue alternative methods of financing. With funds raised through an unrecorded mortgage against the property, additional venture capital, and the sale of X-ray tube power supplies to the medical profession he was able to make ends meet for another couple of years. In spite of valiant efforts to maintain the operation, income dwindled and his employees were eventually dropped from the payroll. Still, Tesla was certain that his wireless system would yield handsome rewards if it could only be set into operation and so the work continued as he was able. A second mortgage in 1908 acquired again from the Waldorf-Astoria proprietor George C. Boldt allowed some additional bills to be paid, but debt continued to mount and between 1912 and 1915 Tesla's financial condition disintegrated. The loss of ability to make additional payments was accompanied by the collapse of his plan for high capacity trans-Atlantic wireless communications. The property was foreclosed, Nikola Tesla honored the agreement with his debtor and title on the property was signed over to Mr. Boldt. The plant's abandonment sometime around 1911-1912 followed by demolition and salvaging of the tower in 1917 essentially brought an end to this era. Tesla's April 20, 1922 loss on

appeal of the judgment completely closed the door to any further chance of his developing the site.

Note: ***Tesla had predicted that further advances would have permitted the wireless transmission of industrial amounts of electrical energy with minimal losses to any point on the earth's surface. Had he been able to complete the prototype station on Long Island and use it to demonstrate the feasibility of wireless power transmission then a plan would have been implemented for the construction of a pilot plant for this larger system at Niagara Falls, site of the world's first commercial three phase AC power plant.***

[NEXT](#)

[BACK](#)

[INDEX](#)

TESLA COILS & THE WORLD SYSTEM

Nikola Tesla's Engineering Legacy

It was around the turn of the century, January 22, 1900, when Nikola Tesla sent his business associate George Westinghouse, Jr. some fascinating news. He wrote confidentially: "I have just returned from Colorado, where I have been carrying on some experiments since a few months past. The success has been even greater than I anticipated, and among other things I have absolutely demonstrated the practicability of the establishment of telegraphic communication to any point on the globe by the help of the machinery I have perfected."

The experiments Tesla referred to were preliminary steps taken toward the construction of a prototype global communications facility on eastern Long Island -- a place known as Wardenclyffe. They centered around a unique form of electrical oscillator that Tesla had developed for the production of high voltage, high frequency alternating electrical currents, an invention which his contemporaries dubbed the "Tesla Coil."

Also known as the disruptive discharge coil, these devices initially served as power supplies for various experimental high frequency electric lamps and other high frequency apparatus. The Tesla coil was subsequently adapted to the generation of radio frequency currents for Tesla's then decade long investigation into wireless transmission, offering a superior alternative to the high frequency electrical alternators that he had also constructed for the same purpose.



Nikola Tesla's historic laboratory and wireless communications facility (left) known as Wardenclyffe, located about 65 miles east of New York City on the North Shore of Long Island. It was here this creative genius worked out the final details related to his "World System" for ground-based global communications. The distinctive 187 foot tall tower was demolished in 1917, but the sturdy 94 foot square building still remains standing in silent testimony to Tesla's unfulfilled dream.

The main component of the classic Tesla coil is an air core electrical step-up transformer -- an assembly of two concentric wire coils positioned in fairly close proximity to each other. When an alternating current passes through the first coil or primary winding a time varying magnetic field is established which allows the transfer of energy by electromagnetic induction to the second coil or secondary winding.

The transformer's primary is excited by the rapid discharge of a high voltage capacitor through a high speed switching device known as a break or circuit controller . The potential which appears at the secondary's high voltage terminal is developed through a process known as resonant rise.

It can greatly exceed the voltage that would be expected from a conventional iron core transformer, using a simple calculation based upon the ratio of primary to secondary turns, that is to say, ratio of transformation. While in operation, the oscillator's primary capacitor is continuously recharged by a regular high voltage transformer, allowing for an uninterrupted flow of radio frequency current in the primary and secondary circuits.



The magnifying transmitter, which was the focus of Tesla's investigations in Colorado, is an advanced form of radio frequency oscillator specifically designed for wireless transmission. In addition to the primary and secondary inductors which made up the classic Tesla coil, Tesla added a third inductor, actually a helical resonator, known as the extra coil.

Power from the grounded primary / secondary combination, now known as the master oscillator, was fed to the lower end of the extra coil helical resonator through a heavy electrical conductor. This centrally located extra coil was separated by a wide space from the other two coils, which comprised the master oscillator section.

Such spacing minimizes inductive coupling between the extra coil and the master oscillator, preventing, for the most part, a portion of the energy that is continuously flowing into the

resonator from passing backward through the system and becoming lost. In addition to maximizing the efficiency of the system, allowing development of the highest possible power output for power consumed, the extra coil also served as the device's main transmitting element. (Operational Tesla Coils - Left and right))



While Tesla's wireless transmitter and present day radio transmitters are fundamentally the same, the method in which Tesla preferred to use his apparatus was radically different from that which is employed in present day radio systems.

Conventional radio transmitters are set up so as to maximize the amount of power radiated from the antenna. When used for long range transmission, such equipment must process tremendous amounts of power in order to counteract the reduction in field strength ($P = 1/R^2$) encountered as the signal radiates outward from its point of origin. In contrast, Tesla's magnifying transmitter was configured so as to minimize the power which was radiated out into space. Instead of being directed into an elevated antenna, the electrical energy flowing through Tesla's transmitter was sent instead into the extra coil.

Rather than acting as a radiator, the large metallic spheroid, now known as an isotropic capacitance, which Tesla positioned above the extra coil was intended only as a reservoir for electrical charge.

Another important component of Tesla's Long Island apparatus was an underground array of iron pipes which extended outward from the bottom of a deep shaft beneath the transmitter tower. When coupled with the transmitter these pipes provided a connection to the earth through which a powerful oscillating electrical current would flow. Unlike a conventional radio transmitter with an antenna that radiates dissipating electromagnetic waves out into space, the magnifying transmitter's extra coil excites a low-frequency ground wave called the Zenneck surface wave. In this case the propagating energy does not radiate into space but is concentrated near the earth's surface. Furthermore, Tesla



asserted that it is possible to periodically disturb the equilibrium of the earth's electrical charge and cause it to oscillate with his apparatus. This would be accomplished by superposing an extra low frequency baseband signal on the somewhat higher frequency signal coursing through the resonator -- the low frequency current in the presence of an enveloping corona-induced plasma of free charge carriers produced by the oscillator in effect "pumping" the earth's charge.

(Pike's Peak Power Station, in Colorado, left)

It is believed the resulting ground current with the associated Zenneck surface wave complex would have propagated wireless transmissions to any distance around the earth with as little as 5% loss due to radiation.

Using a global array of these magnifying transmitters, it was Tesla's plan to establish what he called the World System, providing multichannel global broadcasting, an array of secure wireless telecommunications services, and a long range aid to navigation, including means for the precise synchronization of clocks.

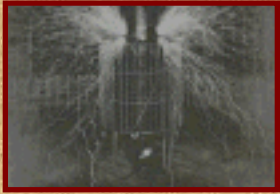

In a more highly developed state he envisioned the World System could expand to include the wireless transmission of electrical power. Tesla at work, left. The shot was taken without Tesla actually in the room with the coil in operation, and the images were combined using a technique similar to a "time delay", double exposure shot. No one could survive in the room with the voltage present, not even Tesla, himself. It does make for a great effect, though, which is exactly what the picture did, at the time.

[**NEXT**](#)

[**BACK**](#)

[**INDEX**](#)

The World System of Power; "Wardenclyffe"

Shoreham, Long Island, New York

THE year 1900 marked to Tesla not only the opening of a new century but also the beginning of the world-superpower and radio-broadcasting era. With the encouragement of J. P. Morgan to spur him on--if he could accommodate any more spurring than his own inner drive furnished--and with \$150,000 in cash from the same source, he was set to embark upon a gigantic venture, the building of a world wireless-power and a world broadcasting station.

The cash on hand would be totally inadequate to finance the project to completion, but this did not deter him from making a start. He needed a laboratory both to replace the Houston Street establishment, which had become entirely inadequate, and to include equipment of the type employed at Colorado Springs, but designed for use in the actual world-broadcasting process. The location was determined as the result of an arrangement he made with James S. Warden, manager and director of the Suffolk County Land Company, a lawyer and banker from the West who had acquired two thousand acres of land at Shoreham, in Suffolk County, Long Island, about sixty miles from New York. The land was made the basis of a real-estate development under the name Wardenclyffe.

Tesla visualized a power-and-broadcasting station which would employ thousands of persons. He undertook the establishment, eventually, of a Radio City, something far more ambitious than the enterprise in Rockefeller Center in New York which bears this name today. Tesla planned to have all wavelength channels broadcast from a single station, a project which would have given him a complete monopoly of the radio-broadcasting business. What an opportunity nearsighted businessmen of his day overlooked in not getting in on his project! But in that day Tesla was about the only one who visualized modern broadcasting.

Everyone else visualized wireless as being useful only for sending telegraphic communications between ship and shore and across the ocean. Mr. Warden saw possibilities of a sort in Tesla's plan, however, and offered him a tract of two hundred acres, of which twenty acres were cleared, for his power station, with the expectation that the two thousand men who would shortly be employed in the station would build homes on convenient sites in the remainder of the 2,000-acre tract. Tesla accepted.

Stanford White, the famous designer of many churches and other architectural monuments throughout the country, was one of Tesla's friends. He now disclosed to the famous architect his vision of an industrial "city beautiful" and sought his cooperation in realizing his dream. Mr. White was enthusiastic about the idea and, as his contribution to Tesla's work, offered to underwrite the cost of designing the strange tower the inventor sketched, and all of the architectural work involved in the general plan for the city. The actual work was done by W. D. Crow, of East Orange, N. J., one of Mr. White's associates, who later became famous as a designer of hospitals and other institutional buildings.

It was a fantastic-looking tower, with strange structural limitations, which Mr. Crow found himself designing. Tesla required a tower, about 154 feet high, to support at its peak a giant copper electrode 100 feet in diameter and shaped like a gargantuan doughnut with a tubular diameter of twenty feet. (This was later changed to a hemispherical electrode.)

The tower would have to be a skeletonized structure, built almost entirely of wood, metal to be reduced to an utter minimum and any metal fixtures employed to be of copper. No engineering data were available on wood structures of this height and type. The structure Tesla required had a large amount of "sail area," or surface exposed to wind, concentrated at the top, creating stresses that had to be provided for in a tower that itself possessed only limited stability. Mr. Crow solved the engineering problems and then the equally difficult task of incorporating esthetic qualities in such an edifice.

When the design was completed another difficulty was encountered. None of the well-known builders could be induced to undertake the task of erecting the tower. A competent framer, associated with Norcross Bros., who were a large contracting firm in those days, finally took over the contract, although he, too, expressed fears that the winter gales might overturn the structure. (It stood, however, for a dozen years. When the Government, for military reasons decided it was necessary to remove this conspicuous landmark during the First World War, heavy charges of dynamite were necessary in order to topple it, and even then it remained intact on the ground like a fallen Martian invader out of Wells' War of the Worlds.)

The tower was completed in 1902, and with it a large low brick building more than 100 feet square which would provide quarters for the powerhouse and laboratory. While the structures were being built, Tesla commuted every day from the Waldorf-Astoria to Wardencllyffe, arriving at the nearby Shoreham station shortly after eleven am and remaining until three-thirty. He was always accompanied by a man servant, a Serbian, who carried a heavy hamper filled with food. When the laboratory transferred from Houston Street was in full operation at Wardencllyffe, Tesla rented the Bailey cottage near the Long Island Sound shore and there made his home for a year.

The heavy equipment, the dynamos and motors, that Tesla desired for his plant were of an unusual design not produced by manufacturers, and he encountered many vexatious delays in securing such material. He was able to carry on a wide range of high-frequency current and other experiments in his new laboratory, but the principal project, that of setting up the worldwide broadcasting station, lagged. Meanwhile, he had a number of glass blowers making tubes for use in transmitting and receiving his broadcast programs. This was a dozen years before De Forest invented the form of radio tube now in general use. The secret of Tesla's tubes died with him.

Tesla seemed to be entirely fearless of his high-frequency currents of millions of volts. He had, nevertheless, the greatest respect for the electric current in all forms, and was extremely careful in working on his apparatus. When working on circuits that might come "alive," he always worked with one hand in his pocket, using the other to manipulate tools. He insisted that all of his workers do likewise when working on the 60-cycle low-frequency alternating-current circuits, whether the potential was 50,000 or 110 volts. This safeguard reduced the possibility of a dangerous current finding a circuit through the arms across the body, where there was chance that it might stop the action of the heart.

In spite of the great care which he manifested in all of his experimental work, he had a narrow escape from losing his life at the Wardencllyffe plant. He was making experiments on the properties of small-diameter jets of water moving at high velocity and under very high pressures, of the order of 10,000 pounds per square inch. Such a stream could be struck by a heavy iron bar without the stream being disrupted. The impinging bar would bounce back as if it had struck another solid iron bar...a strange

property for a mechanically weak substance like water. The cylinder holding the water under high pressure was a heavy one made of wrought iron.

Tesla was unable to secure a wrought-iron cap for the upper surface, so he used a heavier one of cast iron, a more brittle metal. One day when he raised the pressure to a point higher than he had previously used, the cylinder exploded. The cast-iron cap broke and a large fragment shot within a few inches of his face as it went on a slanting path upward and finally crashed through the roof. The high-pressure stream of water had peculiar destructive effects on anything with which it came in contact, even tough, strong metals. Tesla never revealed the purpose or the results of these high-pressure experiments.

Tesla's insistence on the utmost neatness in his laboratory almost resulted in a tragedy through a case of thoughtlessness on the part of an assistant. Arrangements were being made for installing a heavy piece of machinery which was to be lag bolted to the thick concrete floor. Holes had been drilled in the concrete. The plan called for pouring molten lead into these holes and screwing the heavy bolts into the metal when it cooled. As soon as the holes were drilled, a young assistant starting cleaning up the debris. He not only swept up the stone chips and dust: he got a mop and thoroughly washed that area of the floor, thoughtlessly letting some of the water get into the holes. He then dried the floor. In the meantime Tesla and George Scherff, who was his financial secretary but also served in any way in which he could be helpful, were melting the lead which would hold the lag screws in the holes in the floor. Scherff took the first large ladleful of lead from the furnace and started across the laboratory to where the holes had been drilled, followed shortly by Tesla bearing another ladle.

Scherff bent down, and as he poured the hot liquid metal into one of the holes an explosion followed instantly. The molten lead was blown upward into his face in a shower of searing hot drops of liquid metal. The water which the assistant used to swab the floor had settled into the holes and, when the melted lead came in contact with it, it was changed to steam which shot the lead out of the hole like a bullet out of the barrel of a rifle. Both men were showered with drops of hot metal and dropped their ladles. Tesla, being several feet away, was only slightly injured; but Scherff was very seriously burned about the face and hands. Drops of the metal had struck his eyes and so severely burned them that it was feared for a while that his sight could not be saved. However, despite the almost unlimited possibilities for accidents in connection with the vast variety of experiments which Tesla conducted in totally unexplored fields, using high voltages, high amperages, high pressures, high velocities and high temperatures, he went through his entire career with only one accident in which he suffered injury.

In that a sharp instrument slipped, entered his palm and penetrated through the hand. The accident to Scherff was the only one in which a member of his staff was injured, with the exception of a young assistant who developed X-ray burns. He had probably been exposed to the rays from one of Tesla's tubes which, unknown to Tesla and everyone else, had been producing them even before Roentgen announced their discovery. Tesla had given them another name and had not fully investigated their properties. This was probably the first case of X-ray burns on record.

Tesla was an indefatigable worker, and it was hard for him to understand why others were incapable of such feats of endurance as he was able to accomplish. He was willing to pay unusually high wages to workers who were willing to stick with him on protracted tasks but never demanded that anyone work beyond a reasonable day's labor. On one occasion a piece of long-awaited equipment arrived and

Tesla was anxious to get it installed and operating as quickly as possible.

The electricians worked through twenty-four hours, stopping only for meals, and then for another twenty-four hours. The workers then dropped out, one by one, picking out nooks in the building in which to sleep. While they took from eight to twelve hours' sleep, Tesla continued to work; and when they came back to the job Tesla was still going strong and worked with them through his third sleepless twenty-four-hour period. The men were then given several days off in which to rest up; but Tesla, apparently none the worse for his seventy-two hours of toil, went through his next day of experiments, accomplishing a total of eighty-four hours without sleep or rest.

The plant at Wardenclyffe was intended primarily for demonstrating the radio-broadcasting phase of his "World System"; the power-distribution station was to be built at Niagara Falls. Tesla at this time published a brochure on his "World System" which indicates the remarkable state of advancement he had projected in the wireless art, now called radio, while other experimenters were struggling to acquire familiarity with rudimentary devices. At that time, however, his promises seemed fantastic. The brochure contained the following description of his system and his objectives:

The World System has resulted from a combination of several original discoveries made by the inventor in the course of long continued research and experimentation. It makes possible not only the instantaneous and precise wireless transmission of any kind of signals, messages or characters, to all parts of the world, but also the interconnection of the existing telegraph, telephone, and other signal stations without any change in their present equipment. By its means, for instance, a telephone subscriber here may call up any other subscriber on the Globe. An inexpensive receiver, not bigger than a watch, will enable him to listen anywhere, on land or sea, to a speech delivered, or music played in some other place, however distant.

These examples are cited merely to give an idea of the possibilities of this great scientific advance, which annihilates distance and makes that perfect conductor, the Earth, available for all the innumerable purposes which human ingenuity has found for a line wire. One far reaching result of this is that any device capable of being operated through one or more wires (at a distance obviously restricted) can likewise be actuated, without artificial conductors and with the same facility and accuracy, at distances to which there are no limits other than those imposed by the physical dimensions of the Globe. Thus, not only will entirely new fields for commercial exploitation be opened up by this ideal method of transmission, but the old ones vastly extended.

While at work on his Wardenclyffe radio-broadcasting plant, Tesla was also evolving plans for establishing his world power station at Niagara Falls. So sure was he of the successful outcome of his efforts that he stated in a newspaper interview in 1903 that he would light the lamps of the coming international exposition in Paris with power wirelessly transmitted from the Falls. Circumstances, however, prevented him from making good this promise. His difficulties and his plans were outlined in a statement published in the *Electrical World and Engineer*, March 5, 1904: (Below) Compliments: Gary Peterson of 21st Century Books, <http://www.tfcbooks.com>; used by permission

[NEXT](#)

[INDEX](#)

[BACK](#)

TRANSMISSION OF ELECTRICAL ENERGY WITHOUT WIRES

by Nikola Tesla
as communicated to the Thirtieth Anniversary of
the Electrical World and Engineer,
March 5, 1904

It is impossible to resist your courteous request extended on an occasion of such moment in the life of your journal. Your letter has vivified the memory of our beginning friendship, of the first imperfect attempts and undeserved successes, of kindness and misunderstandings. It has brought painfully to my mind the greatness of early expectations, the quick flight of time, and alas! the smallness of realizations. The following lines which, but for your initiative, might not have been given to the world for a long time yet, are an offering in the friendly spirit of old, and my best wishes for your future success accompany them.

Towards the close of 1898 a systematic research, carried on for a number of years with the object of perfecting a method of transmission of electrical energy through the natural medium, led me to recognize three important necessities: First, to develop a transmitter of great power; second, to perfect means for individualizing and isolating the energy transmitted; and, third, to ascertain the laws of propagation of currents through the earth and the atmosphere. Various reasons, not the least of which was the help proffered by my friend Leonard E. Curtis and the Colorado Springs Electric Company, determined me to select for my experimental investigations the large plateau, two thousand meters above sea-level, in the vicinity of that delightful resort, which I reached late in May, 1899. I had not been there but a few days when I congratulated myself on the happy choice and I began the task, for which I had long trained myself, with a grateful sense and full of inspiring hope. The perfect purity of the air, the unequaled beauty of the sky, the imposing sight of a high mountain range, the quiet and restfulness of the place--all around contributed to make the conditions for scientific observations ideal.

To this was added the exhilarating influence of a glorious climate and a singular sharpening of the senses. In those regions the organs undergo perceptible physical changes. The eyes assume an extraordinary limpidity, improving vision; the ears dry out and become more susceptible to sound. Objects can be clearly distinguished there at distances such that I prefer to have them told by someone else, and I have heard, this I can venture to vouch for, the claps of thunder seven and eight hundred kilometers away. I might have done better still, had it not been tedious to wait for the sounds to arrive, in definite intervals, as heralded precisely by an electrical indicating apparatus, nearly an hour before.

In the middle of June, while preparations for other work were going on, I arranged one of my receiving transformers with the view of determining in a novel manner, experimentally, the electric potential of the globe and studying its periodic and casual fluctuations. This formed part of a plan carefully mapped out in advance. A highly sensitive, self-restorative device, controlling a recording instrument, was

included in the secondary circuit, while the primary was connected to the ground and an elevated terminal of adjustable capacity. The variations of potential gave rise to electric surging in the primary; these generated secondary currents, which in turn affected the sensitive device and recorder in proportion to their intensity. The earth was found to be, literally, alive with electrical vibrations, and soon I was deeply absorbed in the interesting investigation. No better opportunities for such observations as I intended to make could be found anywhere.

Colorado is a country famous for the natural displays of electric force. In that dry and rarefied atmosphere the sun's rays beat the objects with fierce intensity. I raised steam, to a dangerous pressure, in barrels filled with concentrated salt solution, and the tinfoil coatings of some of my elevated terminals shriveled up in the fiery blaze. An experimental high-tension transformer, carelessly exposed to the rays of the setting sun, had most of its insulating compound melted out and was rendered useless. Aided by the dryness and rarefaction of the air, the water evaporates as in a boiler, and static electricity is developed in abundance. Lightning discharges are, accordingly, very frequent and sometimes of inconceivable violence. On one occasion approximately twelve thousand discharges occurred in two hours, and all in a radius of certainly less than fifty kilometers from the laboratory. Many of them resembled gigantic trees of fire with the trunks up or down. I never saw fire balls, but as compensation for my disappointment I succeeded later in determining the mode of their formation and producing them artificially.

In the latter part of the same month I noticed several times that my instruments were affected stronger by discharges taking place at great distances than by those near by. This puzzled me very much. What was the cause? A number of observations proved that it could not be due to the differences in the intensity of the individual discharges, and I readily ascertained that the phenomenon was not the result of a varying relation between the periods of my receiving circuits and those of the terrestrial disturbances. One night, as I was walking home with an assistant, meditating over these experiences, I was suddenly staggered by a thought. Years ago, when I wrote a chapter of my lecture before the Franklin Institute and the National Electric Light Association, it had presented itself to me, but I dismissed it as absurd and impossible. I banished it again. Nevertheless, my instinct was aroused and somehow I felt that I was nearing a great revelation.

It was on the third of July--the date I shall never forget--when I obtained the first decisive experimental evidence of a truth of overwhelming importance for the advancement of humanity. A dense mass of strongly charged clouds gathered in the west and towards the evening a violent storm broke loose which, after spending much of its fury in the mountains, was driven away with great velocity over the plains. Heavy and long persisting arcs formed almost in regular time intervals. My observations were now greatly facilitated and rendered more accurate by the experiences already gained. I was able to handle my instruments quickly and I was prepared. The recording apparatus being properly adjusted, its indications became fainter and fainter with the increasing distance of the storm, until they ceased altogether. I was watching in eager expectation. Surely enough, in a little while the indications again began, grew stronger and stronger and, after passing through a maximum, gradually decreased and ceased once more.

Many times, in regularly recurring intervals, the same actions were repeated until the storm which, as evident from simple computations, was moving with nearly constant speed, had retreated to a distance of about three hundred kilometers. Nor did these strange actions stop then, but continued to manifest

themselves with undiminished force. Subsequently, similar observations were also made by my assistant, Mr. Fritz Lowenstein, and shortly afterward several admirable opportunities presented themselves which brought out, still more forcibly, and unmistakably, the true nature of the wonderful phenomenon. No doubt, whatever remained: I was observing stationary waves.

As the source of disturbances moved away the receiving circuit came successively upon their nodes and loops. Impossible as it seemed, this planet, despite its vast extent, behaved like a conductor of limited dimensions. The tremendous significance of this fact in the transmission of energy by my system had already become quite clear to me. Not only was it practicable to send telegraphic messages to any distance without wires, as I recognized long ago, but also to impress upon the entire globe the faint modulations of the human voice, far more still, to transmit power, in unlimited amounts, to any terrestrial distance and almost without loss.

With these stupendous possibilities in sight, and the experimental evidence before me that their realization was henceforth merely a question of expert knowledge, patience and skill, I attacked vigorously the development of my magnifying transmitter, now, however, not so much with the original intention of producing one of great power, as with the object of learning how to construct the best one. This is, essentially, a circuit of very high self-induction and small resistance which in its arrangement, mode of excitation and action, may be said to be the diametrical opposite of a transmitting circuit typical of telegraphy by Hertzian or electromagnetic radiation.

It is difficult to form an adequate idea of the marvelous power of this unique appliance, by the aid of which the globe will be transformed. The electromagnetic radiation being reduced to an insignificant quantity, and proper conditions of resonance maintained, the circuit acts like an immense pendulum, storing indefinitely the energy of the primary exciting impulses and impressions upon the earth of the primary exciting impulses and impressions upon the earth and its conducting atmosphere uniform harmonic oscillations of intensities which, as actual tests have shown, may be pushed so far as to surpass those attained in the natural displays of static electricity.

Simultaneously with these endeavors, the means of individualization and isolation were gradually improved. Great importance was attached to this, for it was found that simple tuning was not sufficient to meet the vigorous practical requirements. The fundamental idea of employing a number of distinctive elements, cooperatively associated, for the purpose of isolating energy transmitted, I trace directly to my perusal of Spencer's clear and suggestive exposition of the human nerve mechanism. The influence of this principle on the transmission of intelligence, and electrical energy in general, cannot as yet be estimated, for the art is still in the embryonic stage; but many thousands of simultaneous telegraphic and telephonic messages, through one single conducting channel, natural or artificial, and without serious mutual interference, are certainly practicable, while millions are possible. On the other hand, any desired degree of individualization may be secured by the use of a great number of cooperative elements and arbitrary variation of their distinctive features and order of succession. For obvious reasons, the principle will also be valuable in the extension of the distance of transmission.

Progress though of necessity slow was steady and sure, for the objects aimed at were in a direction of my constant study and exercise. It is, therefore, not astonishing that before the end of 1899 I completed the task undertaken and reached the results which I have announced in my article in the

Century Magazine of June, 1900, every word of which was carefully weighed.

Much has already been done towards making my system commercially available, in the transmission of energy in small amounts for specific purposes, as well as on an industrial scale. The results attained by me have made my scheme of intelligence transmission, for which the name of "World Telegraphy" has been suggested, easily realizable. It constitutes, I believe, in its principle of operation, means employed and capacities of application, a radical and fruitful departure from what has been done heretofore. I have no doubt that it will prove very efficient in enlightening the masses, particularly in still uncivilized countries and less accessible regions, and that it will add materially to general safety, comfort and convenience, and maintenance of peaceful relations.

It involves the employment of a number of plants, all of which are capable of transmitting individualized signals to the uttermost confines of the earth. Each of them will be preferably located near some important center of civilization and the news it receives through any channel will be flashed to all points of the globe. A cheap and simple device, which might be carried in one's pocket, may then be set up somewhere on sea or land, and it will record the world's news or such special messages as may be intended for it. Thus the entire earth will be converted into a huge brain, as it were, capable of response in every one of its parts. Since a single plant of but one hundred horsepower can operate hundreds of millions of instruments, the system will have a virtually infinite working capacity, and it must needs immensely facilitate and cheapen the transmission of intelligence.

"The first of these central plants would have been already completed had it not been for unforeseen delays which, fortunately, have nothing to do with its purely technical features. But this loss of time, while vexatious, may, after all, prove to be a blessing in disguise. The best design of which I know has been adopted, and the transmitter will emit a wave complex of a total maximum activity of 10,000,000 horsepower, one percent of which is amply sufficient to "girdle the globe." This enormous rate of energy delivery, approximately twice that of the combined falls of Niagara, is obtainable only by the use of certain artifices, which I shall make known in due course.

For a large part of the work which I have done so far I am indebted to the noble generosity of Mr. J. Pierpont Morgan, which was all the more welcome and stimulating, as it was extended at a time when those, who have since promised most, were the greatest of doubters. I have also to thank my friend Stanford White, for much unselfish and valuable assistance. This work is now far advanced, and though the results may be tardy, they are sure to come. Meanwhile, the transmission of energy on an industrial scale is not being neglected. The Canadian Niagara Power Company have offered me a splendid inducement, and next to achieving success for the sake of the art, it will give me the greatest satisfaction to make their concession financially profitable to them. In this first power plant, which I have been designing for a long time, I propose to distribute 10,000 horsepower under a tension of 10,000,000 volts, which I am now able to produce and handle with safety.

This energy will be collected all over the globe preferably in small amounts, ranging from a fraction of one to a few horsepower. One of the chief uses will be the illumination of isolated homes. It takes very little power to light a dwelling with vacuum tubes operated by high frequency currents and in each instance a terminal a little above the roof will be sufficient. Another valuable application will be the driving of clocks and other such apparatus. These clocks will be exceedingly simple, will require absolutely no attention and will indicate rigorously correct time. The idea of impressing upon the earth

American time is fascinating and very likely to become popular.

There are innumerable devices of all kinds which are either now employed or can be supplied and by operating them in this manner I may be able to offer a great convenience to the whole world with a plant of no more than 10,000 horsepower. The introduction of this system will give opportunities for invention and manufacture such as have never presented themselves before. Knowing the far reaching importance of this first attempt and its effect upon future development, I shall proceed slowly and carefully. Experience has taught me not to assign a term to enterprises the consummation of which is not wholly dependent on my own abilities and exertions. But I am hopeful that these great realizations are not far off and I know that when this first work is completed they will follow with mathematical certitude.

When the great truth accidentally revealed and experimentally confirmed is fully recognized, that this planet, with all its appalling immensity, is to electric current virtually no more than a small metal ball and that by this fact many possibilities, each baffling the imagination and of incalculable consequence, are rendered absolutely sure of accomplishment; when the first plant is inaugurated, and it is shown that a telegraphic message, almost as secret and non-interferable as a thought, can be transmitted to any terrestrial distance, the sound of the human voice, with all its intonations and injections, faithfully and instantly reproduced at any point of the globe, the energy of a waterfall made available for supplying light, heat or motive power, anywhere on sea, or land, or high in the air...humanity will be like an ant heap stirred up with a stick: See the excitement coming. "

-End-

Summation:

The Niagara Falls plant was never built; and difficulties, soon enough, were encountered at the Wardenclyffe plant not only in securing desired equipment but also finances. Tesla's greatest oversight was that he neglected to invent, so to speak, a device for making the unlimited quantities of money that were necessary to develop his other inventions. As we have seen, he was utterly lacking in the phase of personality that made possible the securing of financial returns directly from his inventions. An individual with his ability could have made millions out of each of a number of Tesla's minor inventions.

If he had taken the trouble, for example, to collect annual royalties on twenty or more different kinds of devices put out by as many manufacturers employing his Tesla coil for medical treatments, he would have had ample income to finance his World Wireless System.

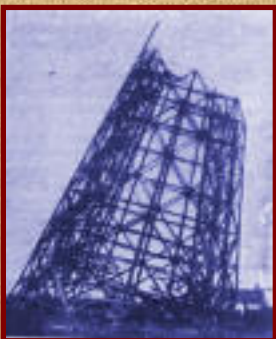

His mind, however, was too fully occupied with fascinating scientific problems. He had, at times, nearly a score of highly skilled workmen constantly employed in his laboratory developing the electrical inventions he was continuing to make at a rapid rate. Armed guards were always stationed around the laboratory to prevent spying on his inventions. His payroll was heavy, his bank balance became dangerously low, but he was so immersed in his experimental work that he continuously put off the task of making an effort to repair his finances.

He soon found himself facing judgments obtained by creditors on accounts upon which he could not

make payments. He was forced, in 1905, to close the Wardenclyffe laboratory... The fantastic tower in front of the laboratory was never completed. The doughnut-shaped copper electrode was never built because Tesla changed his mind and decided to have a copper hemisphere 100 feet in diameter and 50 feet high built on top of the 154-foot cone-shaped tower.

A skeleton framework for holding the hemispherical plates was built, but the copper sheeting was never applied to it. The 300-horsepower dynamos and the apparatus for operating the broadcasting station were left intact, but they were eventually removed by the engineering firm that installed them and had not been paid. "Prodigal Genius. by, John O'Neil" excerpt.

WIRELESS TRANSMISSION OF ELECTRICITY to ANY point on earth...To see what would happen if we were to build, and "operate" one of Tesla's Magnifying Transmitters...click here:

Two choices - Yes, it could be built: [Tesla's Magnifying Transmitter - A historical Prospective.](#)

Or...no, we probably shouldn't...[Tesla- The Greatest "Hacker" Of All Time?!](#)

Wardenclyffe today: located in Shoreham, LI right on Route 25A, at the intersection with Tesla St., the Wardenclyffe lab building is in good shape and looks much as it did a century ago (minus the dramatic tower), though it has become a bit overgrown.

Want to DRIVE to Wardenclyffe? It's pretty easy to get to, being just off Route 25 on Long Island, NY. [Click here for a link to a printable map from Yahoo.com](#)



Owned today by "Agfa", there are movements afoot to turn it into a museum. Check with [Gary Peterson of 21st Century Books](#) to see how you can assist in this historic building becoming a Nikola Tesla Museum, learning center, library, and R&D Laboratory.

Tesla was depending on high earth conductivity to contain any energy that was not immediately used by subscribers. His proof of this was the existence of standing waves in the earth. Too darn bad no one listened. But, here's a promise - International Turbine And Power, LLC, with my direction, and the Tesla Wardenclyffe Project, will bring this building "back to life" if at all possible. Period. FDG.

References :

- [1] Nikola Tesla, U.S. Patent #512,340, "COIL FOR ELECTRO MAGNETS," he explains that a standard coil of 1000 turns with a potential of 100 volts across it will have a difference of .1 volt between turns. A similar bifilar coil will have a potential of 50 volts between turns. In that the stored energy is a function of the square of the voltages the energy in the bifilar will be $50^2/.1^2 = 2500/.01 = 250,000$ times greater than the standard coil.
- [2] Michael Pupin, From Immigrant to Inventor, Charles Scribner's Sons, N.Y., pages 285-286, 1923.
-

Let's see what other fantastic stories we can uncover, shall we? We're a long way from concluding this amazing journey into the life of Nikola Tesla!

[[The Wonder World To Be Created By Electricity](#)] and [[A Machine To End War](#)]

[[The Lost Inventions of Nikola Tesla](#)]

[[Nikola Tesla On His Work With Alternating Currents](#)]

[[Nikola Tesla's Radiant Energy System](#)]

[[Nikola Tesla's Earthquake Machine!](#)]

[[Famous Quotes from Nikola Tesla](#)]

[Help Frank Germano](#)

I hope you have enjoyed the information presented on this page. I also hope that you will take something away with you - knowledge. Nikola Tesla was perhaps the most important figure in the twentieth century. Think of the world today, and what it would be like without the contributions Tesla gave us. Thank You for visiting the site.

Frank Dominic Germano, President, International Turbine And Power

frank@germano.com

Subscribe to [TheTeslaTurbineList](#)

Powered by groups.yahoo.com

Suggested Books:



Wizard : The Life and Times of Nikola Tesla :

Biography of a Genius Marc J. Seifer / Hardcover / Published 1996 (Publisher Out Of Stock) WIZARD: THE LIFE & TIMES OF NIKOLA TESLA has taken me 20 years to write. My key reasons for writing the book were to try and answer many of the questions left unanswered by the other authors, such as why Tesla's name dropped into obscurity, whether or not he really received signals from Mars, how his magnifying transmitter really worked, what exactly happened to cause his failure with JP Morgan, what happened to his secret particle beam weaponry papers, and would his particle beam weapon have really worked. The book is set up completely chronologically, and begins with a quote for each chapter. It also differs from the other biographies in a number of other ways mainly because I had access to hundreds of documents which had never been published before, many received through the Freedom of Information Act. For instance, for the first time ever, WIZARD explains why Tesla stopped working for Edison, why Steinmetz dropped Tesla's name from his textbooks on AC power, why Michael Pupin never mentioned Tesla's name in his physics courses at Columbia University, how Tesla pre-dated Rutherford, Bohr and Einstein in theories on the structure of the atom and on what came to be called Quantum physics, how Marconi pirated Tesla's apparatus, why Tesla had a falling out with his editor TC Martin, John Jacob Astor, JP Morgan and John Hayes Hammond Jr, what Tesla's link to the Navy was, how Franklin Roosevelt used the Tesla patents to block payments on wireless apparatus to Marconi, yet at the same time cut Tesla out of the Marconi/Sarnoff/Westinghouse deal to create RCA, how Tesla interacted with Telefunken, the German wireless concern during WWI and the US War Department during WWII to help them design a particle beam weapon, and how and why Tesla's name has been picked up by cult circles.

This new trade paperback edition has a new illustration of Tesla's flying wing VTOL which was a forerunner of Lockheed Martin's X-33 which will replace the shuttle, and also a new section on the June 1908 explosion at Tunguska Siberia. The book contains over 1400 endnotes including references to 250 documents never published before, a full bibliography and index, and 16 pages of photos. Best wishes, Marc J. Seifer, Ph.D. Author .

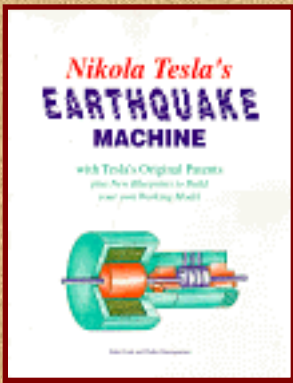

 Buy from **amazon.com**

Nikola Tesla's Earthquake Machine ~

Usually ships in 24 hours Dale Pond, et al / Paperback / Published 1995 Our Price: \$16.95 Reviews : Book Description In 1935, Nikola Tesla revealed that an earthquake in the region of his New York laboratory in 1898 was the result of a machine he had been experimenting with. This book presents his technology based on sonic vibrations. Now for the first time the secrets of the Tesla Oscillator are available to both the layman and advanced researcher. INTRODUCTION: ,

This manual presents a new technology. It is based on SONIC VIBRATIONS which can be produced by a comparatively simple apparatus. Although sonic vibrations can be similar in their effects and in their wave mechanics like electro-magnetic oscillations, the writer has good reason to believe that this proposed system is fundamentally different in so far as the MANNER OF PRODUCTION of sonic vibrations is concerned. There is much sonic equipment available now on the market for different purposes. It all has nothing to do with the system in this manual. In the oscillators or transmitters described in this report, a RESONANCE EFFECT can be observed. Since resonance appears to be an ever expanding, magnifying effect with these transmitters, to the extent that they would self destruct the apparatus if uncontrolled, it can be deduced that there must be a great source of energy available to them. The very opposite is the truth of the matter however - very little input energy is required to set the device in motion and build that motion to tremendous levels of useable energy. The principle employed is called "Amplitude Modulation Additive Synthesis" by the music industry engineers. We have included a full chapter on the vibration physics to explain what happens and how. With a few simple formulas and a few basic concepts the writers propose to show why certain resonance effects concerning this type of apparatus go on ever increasing in amplitude. Many measurements have yet to be performed by qualified and competent engineers in their different fields of expertise to derive a complete understand of the device and its attendant phenomena... Much experimentation has been done with the sonic transmitters by Nikola Tesla from whom some of the basic principles have been taken by the writers and further elaborated on. Many of Tesla's earlier experiments have been repeated and we believe that it is he who deserves the credit for having discovered these very fundamental principles of the device and its functions. Further elaboration has been brought in from John Keely's work with the fundamental principles of vibration physics and from a number of conventional sources dealing with vibration, sound and noise fundamentals. In modern times sound and vibration are being used more and more. The physics of these forces are becoming more known and useable. Sound is a rich source of energies and forces not completely understood and harnessed yet.



 Buy from **amazon.com**

Secrets of Cold War Technology: Project

HAARP and Beyond, by Gerry Vassilatatos, Our Price: \$15.95 Now, Free Shipping!

Editorial Reviews

Book Description : In Secrets of Cold War Technology, Gerry Vassilatatos reveals that "Death Ray" technology has been secretly researched and developed since the turn of the century. Included are chapters on H. C. Vion, the developer of auroral energy

receivers; Dr. Selim Lemstrom's pre-Tesla experiments; the early beam weapons of Grindell-Mathews; John Hettenger and his early beam power systems; Ulivi Turpain and others. Learn about Project Argus, Project Teak and Project Orange; EMP experiments back in the '60s; why the Air Force directed the construction of a huge ionospheric "backscatter" telemetry system across the Pacific just after World War II; why Raytheon has collected every patent relevant to HAARP over the past few years; and much more pertinent information on hidden Cold War technology.

About the Author : Gerry Vassilatos is a high school science teacher who lives in New York City. He is the author of The Lost Science, another forthcoming book from Adventures Unlimited.

Although this book doesn't fall into the scientific realms of the previous books, I thought I would do my small part in offering here on my website. This information must become public knowledge. I am not taking any particular political stance - neither Democrat nor Republican...but, with the information presented by Kennedy in this book - you make up your own mind as to what is really happening in America today. Tesla would be saddened, I am sure -



[SITE INDEX](#)

NIKOLA TESLA:

[\[Home\]](#)[\[Tesla Technology, Today\]](#)[\[Nikola Tesla\]](#)
[\[Tesla Tunguska; Free Energy\]](#)
[\[The Tesla Bladeless Boundary Disk Turbine\]](#)
[\[Tesla's "Black Box"\]](#)[\[Greatest Hack of All Time?\]](#)
[\[the Lost Tesla Inventions\]](#)[\[A Machine To End War\]](#)
[\[the Wonderworld to be Created by Electricity\]](#)

[[the Nikola Tesla & Viktor Schauburger -plus- Bookstore](#)]

VIKTOR SCHAUBERGER:

[[Water Power - Vortex Theories-](#)][[Water Power II](#)]

[[Viktor Schauburger -1-](#)][[Viktor Schauburger -2-](#)][[Viktor Schauburger -3-](#)][[Viktor Schauburger -4-](#)]

[[Christian Links](#)]



Tesla's Earthquake Machine

Excerpt from the New York World Telegram, July 11, 1935 -

Nikola Tesla revealed that an earthquake which drew police and ambulances to the region of his laboratory at 48 E. Houston St., New York, in 1898, was the result of a little machine he was experimenting with at the time which "you could put in your overcoat pocket."

The bewildered newspapermen pounced upon this as at least one thing they could understand and "the father of modern electricity" told what had happened as follows:

"I was experimenting with vibrations. I had one of my machines going and I wanted to see if I could get it in tune with the vibration of the building. I put it up notch after notch. There was a peculiar cracking sound.

"I asked my assistants where did the sound come from. They did not know. I put the machine up a few more notches. There was a louder cracking sound. I knew I was approaching the vibration of the steel building. I pushed the machine a little higher. "Suddenly all the heavy machinery in the place was flying around. I grabbed a hammer and broke the machine. The building would have been about our ears in another few minutes. Outside in the street there was pandemonium.

"The police and ambulances arrived. I told my assistants to say nothing. We told the police it must have been an earthquake. That's all they ever knew about it."

Some shrewd reporter asked Dr. Tesla at this point what he would need to destroy the Empire State Building and the doctor replied: "Vibration will do anything. It would only be necessary to step up the vibrations of the machine to fit the natural vibration of the building and the building would come crashing down. That's why soldiers break step crossing a bridge."

His early experiments in vibration, he explained, led to his invention of his "earth vibrating" machine. (For more detailed information on this device, please check out a fantastic book, by Dale Pond - "Tesla's Earthquake Machine." Pick one up from Amazon.com, below)

[INDEX](#)

[HOME](#)

[NIKOLA TESLA PAGE](#)

[BOOKSTORE](#)

NIKOLA TESLA'S RADIANT ENERGY SYSTEM

Brooklyn Eagle July 10, 1932

Nikola Tesla states: I have harnessed the cosmic rays and caused them to operate a motive device. Cosmic ray investigation is a subject that is very close to me. I was the first to discover these rays and I naturally feel toward them as I would toward my own flesh and blood. I have advanced a theory of the cosmic rays and at every step of my investigations I have found it completely justified. The attractive features of the cosmic rays is their constancy. They shower down on us throughout the whole 24 hours, and if a plant is developed to use their power it will not require devices for storing energy as would be necessary with devices using wind, tide or sunlight. All of my investigations seem to point to the conclusion that they are small particles, each carrying so small a charge that we are justified in calling them neutrons. They move with great velocity, exceeding that of light. More than 25 years ago I began my efforts to harness the cosmic rays and I can now state that I have succeeded in operating a motive device by means of them. I will tell you in the most general way, the cosmic ray ionizes the air, setting free many charges ions and electrons. These charges are captured in a condenser which is made to discharge through the circuit of the motor. I have hopes of building my motor on a large scale, but circumstances have not been favorable to carrying out my plan.

Device to Harness Cosmic Energy Claimed by Tesla: New York American November 1st, 1933

"This new power for the driving of the world's machinery will be derived from the energy which operates the universe, the cosmic energy, whose central source for the earth is the sun and which is everywhere present in unlimited quantities."

This is a diagram of Tesla's first radiant energy receiver. It stored static electricity obtained from the air and converted it to a usable form. Tesla's invention is a simple version of T.H. Moray's device. Moray's device used a unique rectifier (RE-valve) to efficiently capture the static electricity from the surrounding air. Moray's oscillator tubes (magnetron transducers) utilized this high-voltage energy to generate an internal secondary "cold" fusion reaction.

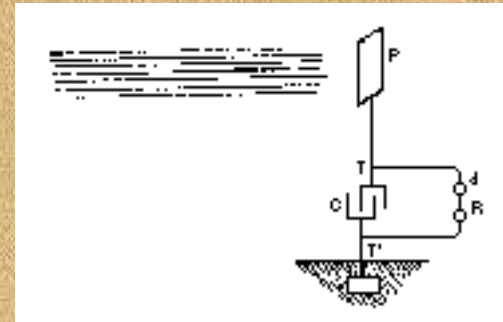

Stick an antenna up in the air, the higher the better, and wire it to one side of a capacitor, the other going to a good earth ground, and the potential difference will then charge the capacitor. Connect across the capacitor some sort of switching device so that it can be discharged at rhythmic intervals, and you have an oscillating electric output. T.H. Moray simply expanded on Tesla's idea to use high-voltage to create ionic oscillation.

Tesla's free-energy concept was patented in 1901 as an "Apparatus for the Utilization of Radiant Energy." The patent refers to "the sun, as well as other sources of radiant energy, like cosmic rays," that the device works at night is explained in terms of the nighttime availability of cosmic rays. Tesla

also refers to the ground as "a vast reservoir of negative electricity."

Tesla was fascinated by radiant energy and its free-energy possibilities. He called the Crooke's radiometer, a device which has vanes that spin in a vacuum when exposed to radiant energy "a beautiful invention." He believed that it would become possible to harness energy directly by "connecting to the very wheel-work of nature." On his 76th birthday at his yearly ritual press conference, Tesla announced a "cosmic-ray motor" when asked if it was more powerful than the Crooke's radiometer, he answered, "thousands of times more powerful."

In 1901 Nikola Tesla was one the first to identify "radiant energy." Tesla says that the source of this energy is our Sun. He concluded that the Sun emits small particles, each carrying so small of a charge, that they move with great velocity, exceeding that of light. Tesla further states that these particles are the neutron particles. Tesla believed that these neutron particles were responsible for all radioactive reactions. Radiant matter is in tune with these neutron particles. Radiant matter is simply a re-transmitter of energy from one state to another.

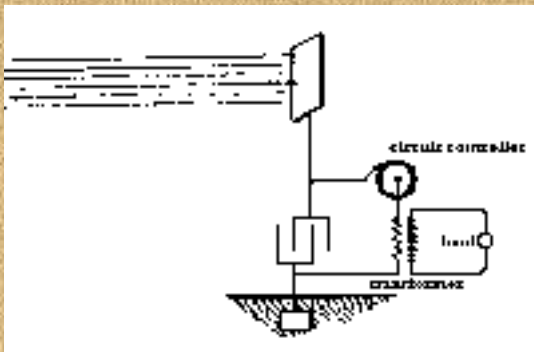

How his radiant energy receiver worked:

From the electric Potential that exists between the elevated plate (plus) and the ground (minus), energy builds up in the capacitor, and, after

"a suitable time interval," the accumulated energy will "manifest itself in a powerful discharge" that can do work. The capacitor, says Tesla, should be "of considerable electrostatic capacity," and its dielectric made of "the best quality mica, for it has to withstand potentials that could rupture a weaker dielectric."

Tesla gives various options for the switching device. One is a rotary switch that resembles a Tesla circuit controller, another is an electrostatic device consisting of two very light, membranous conductors suspended in a vacuum. These sense the energy buildup in the capacitor, one charging positive, the other negative, and, at a certain charge level, are attracted, touch, and thus fire the capacitor. Tesla also mentions another switching device consisting of a minute air gap or weak dielectric film that breaks down suddenly when a certain potential is reached.

Tesla received two patents for this radiant energy device, "Apparatus for the Utilization of Radiant Energy," number 685,957, that was filed for on March 21, 1901 and granted on November 5, 1901. The other, "Apparatus for the Utilization of Radiant Energy," number 685,957, that was filed for on March 21, 1901 and was granted on November 5, 1901. In these patents he explains:

"The sun, as well as other sources of radiant energy throw off minute particles of matter positively electrified, which, impinging upon the upper plate, communicate continuously an electrical charge to the same. The opposite terminal of the condenser being connected to ground, which may be considered as a vast reservoir of negative electricity, a feeble current flows continuously into the condenser and inasmuch as the particles are charged to a very high potential, this charging of the condenser may continue, as I have actually observed, almost indefinitely, even to the point of rupturing

the dielectric."

The Earth's Electrostatic Charge

Tesla's intent was to condense the energy trapped between the earth and its upper atmosphere and to transform it into an electric current. He pictured the sun as an immense ball of electricity, positively charged with a potential of some 200 billion volts. The earth, on the other hand, is charged with negative electricity. The tremendous electrical force between these two bodies constituted, at least in part, what he called cosmic energy. It varied from night to day and from season to season but it is always present.

The positive particles are stopped at the ionosphere and between it and the negative charges in the ground, a distance of 60 miles, there is a large difference of voltage - something on the order of 360,000 volts. With the gases of the atmosphere acting as an insulator between these two opposite stores of electrical charges, the region between the ground and the edge of space traps a great deal of energy. Despite the large size of the planet, it is electrically like a capacitor which keeps positive and negative charges apart by using the air as a non-conducting material as an insulator.

The earth has a charge of 96,500 coulombs. With a potential of 360,000 volts, the earth constitutes a capacitor of .25 farads (farads = coulombs/volts). If the formula for calculating the energy stored in a capacitor ($E = 1/2CV^2$) is applied to the earth, it turns out that the ambient medium contains 1.6×10^{11} joules or 4.5 megawatt-hours of electrical energy. In order to utilize this high-voltage energy you must do two things -- make an energy sink and then devise a way of making the "sink" oscillate.

"Zero-Point Energy?"

Such a "sink" has to be at a lower energy state than the surrounding medium and, for the energy to continually flow into it, the energy must be continually pumped out of it. Additionally, this "sink" must maintain a lower energy state while meeting the power requirements of the load attached to it. Electrical energy, watt-seconds, is a product of volts x amps x seconds. Because the period of oscillation does not change, either voltage or current has to be the variable in this system's energy equation. Bifilar wound coils are used in the system because a bifilar wound coil maximizes the voltage difference between its turns, the current is then minimized.

A coil in our system, then, will be set into oscillation at its resonant frequency by an external power source. During the "zero-point" portion of its cycle the coil will appear as one plate of a capacitor. As the voltage across the coil increases, the amount of charge it can siphon will increase. The energy that is taken into the coil through the small energy window (zero-point), call it what you will, appears to be the key to the success of this system. It is at this zero-point where energy is condensed into positive and negative components of current. When energy escapes from the "sink" the magnetic field collapses and a strong magnetic quake is created in its wake. A properly tuned system can capture and convert radiant energy in such a prescribed arrangement.

Energy Directly from the Atom

The radiant energy system is a self-oscillating capacitive system. Once it is set into oscillation, very little power is expended in keeping it going. Because it is an electrostatic oscillating system, only a small amount of charge moves through the system per cycle, that is, the coulomb per seconds = amps are low. If the charge is used at a low rate, the energy stored in the system will be turned into heat at a slow rate enabling the oscillations to continue for a long period of time.

Tesla's "COIL FOR ELECTRO MAGNETS," patent #512,340 is a very special coil design because, unlike an ordinary coil made by turning wire on a tube form, this one uses two wires laid next to each other on a form but with the end of the first one connected to the beginning of the second one. In this patent Tesla explains that the double coil will store many times the energy of a conventional coil.[1] Measurements of two coils of the same size and with the same number of turns, one with a single, the other with a bifilar winding, show differences in voltage gain. These bifilar Tesla's coils can be explained solely on the basis of their electrical activity. A bifilar coil is capable of holding more charge than a single wound coil. When operated at resonance, the distributed capacitance of the bifilar coil is able to overcome the counter - electromotive force (e.m.f.) normal to coils, inductive reactance.

Because of the electrical activity, a bifilar coil does not work against itself in the form of a counter - e.m.f., the potential across the coil quickly builds to a high value. The difference between the turns becomes great enough that the energy is practically all potential, at this point, the system becomes an electrostatic oscillator.

Minimal work is done in my radiant energy system due to the absence of wasted displacement currents. As small heat losses occur, oscillations are maintained by surplus charge generated by atomic catalytic reactions, energy is siphoned from the kinetic moments of these charges. Very low energy expenditure allows power delivery to an electrical load over an extended time period without an external fuel supply. After an initial input of energy from an outside source, the radiant energy electrical generator will operate as a very efficient device.

By reviewing history it is understandable why some inventions are not commercialized. It is economics, not science, that is the main factor. It will be remembered that alternating current was opposed by powerful financiers in Tesla's time.

Michael Pupin, noted in his autobiography: "...captains of industry...who were afraid that they would have to scrap some of their direct current apparatus and the plants for manufacturing it, if the alternating current system received any support. A most un-American attitude...but ignorance and false notions prevailed in the early nineties, because the captains of electrical industries paid small attention to highly trained scientists."[2]

Philadelphia Public Ledger November 2, 1933: Tesla 'Harnesses' Cosmic Energy

Inventor announces discovery to displace fuel in driving machinery. Calls Sun main source. A principle by which power for driving machinery of the world may be developed from the cosmic energy which operates the universe, has been discovered by Nikola Tesla, noted physicist and inventor of scientific devices, he announced today. This principle, which taps a source of power described as "everywhere present in unlimited quantities" and which may be transmitted by wire or wireless from central plants to

any part of the globe, will eliminate the need of coal, oil, gas or any other of the common fuels, he said.

Dr. Tesla in a statement today at his hotel indicated the time was not far distant when the principle would be ready for practical commercial development. Asked whether the sudden introduction of his principle would upset the present economic system, Dr. Tesla replied, "It is badly upset already." He added that now as never before was the time ripe for the development of new resources. While in its present form, the theory calls for the development of energy in central plants requiring vast machinery. Dr. Tesla said he might be able to work out a plan for its use by individuals. The central source of cosmic energy for the earth is the Sun, Dr. Tesla said, but "night will not interrupt the flow of new power supply."

Clearly Tesla is not talking about an atomic reactor. He is directly converting ionized particles generated by radiant matter. It is not nuclear energy as we know it today. Radiant Energy is directly converted to electrical power! Tesla believed that the Sun generates highly charged particles and that radiant matter is a re-transmitter of energy, it is this transfer of energy that could be used for practical purposes.

[HOME](#)

[INDEX](#)

[NIKOLA TESLA](#)

Quotes from Nikola Tesla:

On Invention: It is the most important product of man's creative brain. The ultimate purpose is the complete mastery of mind over the material world, the harnessing of human nature to human needs.

Of all the frictional resistance, the one that most retards human movement is ignorance, what Buddha called "the greatest evil in the world." The friction which results from ignorance can be reduced only by the spread of knowledge and the unification of the heterogeneous elements of humanity. No effort could be better spent.

Universal peace as a result of cumulative effort through centuries past might come into existence quickly -- not unlike a crystal that suddenly forms in a solution which has been slowly prepared.

George Westinghouse was a man with tremendous potential energy of which only part had taken kinetic form. Like a lion in the forest, he breathed deep and with delight the smoky air of his Pittsburgh factories. Always affable and polite, he stood in marked contrast to the small-minded financiers I had been trying to negotiate with before I met him. Yet, no fiercer adversary could have been found when aroused. Westinghouse welcomed the struggle and never lost confidence. When others would give up in despair, he triumphed.

The last 29 days of the month [are] the hardest.

No matter what we attempt to do, no matter to what fields we turn our efforts, we are dependent on power. We have to evolve means of obtaining energy from stores which are forever inexhaustible, to perfect methods which do not imply consumption and waste of any material whatever. If we use fuel to get our power, we are living on our capital and exhausting it rapidly. This method is barbarous and wantonly wasteful and will have to be stopped in the interest of coming generations.

The scientific man does not aim at an immediate result. He does not expect that his advanced ideas will be readily taken up. His work is like that of a planter -- for the future. His duty is to lay foundation of those who are to come and point the way.

Even matter called inorganic, believed to be dead, responds to irritants and gives unmistakable evidence of a living principle within. Everything that exists, organic or inorganic, animated or inert, is susceptible to stimulus from the outside.

Science is but a perversion of itself unless it has as its ultimate goal the betterment of humanity.

We are confronted with portentous problems which can not be solved just by providing for our material existence, however abundantly. On the contrary, progress in this direction is fraught

with hazards and perils not less menacing than those born from want and suffering. If we were to release the energy of the atoms or discover some other way of developing cheap and unlimited power at any point of the globe this accomplishment, instead of being a blessing, might bring disaster to mankind... The greatest good will come from the technical improvements tending to unification and harmony, and my wireless transmitter is preeminently such. By its means the human voice and likeness will be reproduced everywhere and factories driven thousands of miles from waterfalls furnishing the power; aerial machines will be propelled around the earth without a stop and the sun's energy controlled to create lakes and rivers for motive purposes and transformation of arid deserts into fertile land... (Nikola Tesla, "My Inventions: the autobiography of Nikola Tesla", Hart Bros., 1982. Originally appeared in the Electrical experimenter magazine in 1919.)

War cannot be avoided until the physical cause for its recurrence is removed and this, in the last analysis, is the vast extent of the planet on which we live. Only through annihilation of distance in every respect, as the conveyance of intelligence, transport of passengers and supplies and transmission of energy will conditions be brought about some day, insuring permanency of friendly relations. What we now want is closer contact and better understanding between individuals and communities all over the earth, and the elimination of egoism and pride which is always prone to plunge the world into primeval barbarism and strife... Peace can only come as a natural consequence of universal enlightenment... (Nikola Tesla, "My Inventions: the autobiography of Nikola Tesla", Hart Bros., 1982. Originally appeared in the Electrical experimenter magazine in 1919.)

In our dynamo machines, it is well known, we generate alternate currents which we direct by means of a commutator, a complicated device and, it may be justly said, the source of most of the troubles experienced in the operation of the machines. Now, the currents, so directed cannot be utilized in the motor, but must - again by means of a similar unreliable device - be reconverted into their original state of alternate currents. The function of the commutator is entirely external, and in no way does it affect the internal workings of the machines. In reality, therefore, all machines are alternate current machines, the currents appearing as continuous only in the external circuit during the transfer from generator to motor. In view simply of this fact, alternate currents would commend themselves as a more direct application of electrical energy, and the employment of continuous currents would only be justified if we had dynamos which would primarily generate, and motors which would be directly actuated by, such currents. (Adopted from T.C. Martin, "The Inventions, Researches and Writings of Nikola Tesla," New York: Electrical Engineer, 1894, pp. 9-11.)

On George Westinghouse: George Westinghouse was, in my opinion, the only man on this globe who could take my alternating-current system under the circumstances then existing and win the battle against prejudice and money power. He was a pioneer of imposing stature, one of the world's true nobleman of whom America may well be proud and to whom humanity owes an immense debt of gratitude. (Speech, Institute of Immigrant Welfare, Hotel Baltimore, New York, May 12, 1938, read in absentia.)

On Edison: If Edison had a needle to find in a haystack, he would proceed at once with the diligence of the bee to examine straw after straw until he found the object of his search. ...

I was a sorry witness of such doings, knowing that a little theory and calculation would have saved him ninety per cent of his labor. (New York Times, October 19, 1931.)

On Voltaire: I had a veritable mania for finishing whatever I began, which often got me into difficulties. On one occasion I started to read the works of Voltaire when I learned, to my dismay, that there were close on one hundred large volumes in small print which that monster had written while drinking seventy-two cups of black coffee per diem. It had to be done, but when I laid aside the last book I was very glad, and said, "Never more!" (Nikola Tesla, "My Inventions: the autobiography of Nikola Tesla", Hart Bros., 1982. Originally appeared in the Electrical experimenter magazine in 1919.)

On Mark Twain: I had hardly completed my course at the Real Gymnasium when I was prostrated with a dangerous illness or rather, a score of them, and my condition became so desperate that I was given up by physicians. During this period I was permitted to read constantly, obtaining books from the Public Library which had been neglected and entrusted to me for classification of the works and preparation of the catalogues. One day I was handed a few volumes of new literature unlike anything I had ever read before and so captivating as to make me utterly forget my hopeless state. They were the earlier works of Mark Twain and to them might have been due the miraculous recovery which followed. Twenty-five years later, when I met Mr. Clemens and we formed a friendship between us, I told him of the experience and was amazed to see that great man of laughter burst into tears. (Nikola Tesla, "My Inventions: the autobiography of Nikola Tesla", Hart Bros., 1982. Originally appeared in the Electrical experimenter magazine in 1919.)

[INDEX](#)

[HOME](#)

[NIKOLA TESLA PAGE](#)

[BOOKSTORE](#)

A MACHINE TO END WAR

A Famous Inventor, Picturing Life 100 Years from Now,
Reveals an Astounding Scientific Venture Which He Believes Will Change the Course of History ,
February 1937

by Nikola Tesla
as told to
George Sylvester Viereck

Nikola Tesla: "It seems," he says, "that I have always been ahead of my time."

Editor's Note: Nikola Tesla, now in his seventy-eighth year, has been called the father of radio, television, power transmission, the induction motor, and the robot, and the discoverer of the cosmic ray. Recently he has announced a heretofore unknown source of energy present everywhere in unlimited amounts, and he is now working upon a device which he believes will make war impracticable.

Tesla and Edison have often been represented as rivals. They were rivals, to a certain extent, in the battle between the alternating and direct current in which Tesla championed the former. He won; the great power plants at Niagara Falls and elsewhere are founded on the Tesla system. Otherwise the two men were merely opposites. Edison had a genius for practical inventions immediately applicable. Tesla, whose inventions were far ahead of the time, aroused antagonisms which delayed the fruition of his ideas for years.

However, great physicists like Kelvin and Crookes spoke of his inventions as marvelous. "Tesla," said Professor A. E. Kennelly of Harvard University when the Edison medal was presented to the inventor, "set wheels going round all over the world. . . . What he showed was a revelation to science and art unto ail time."

"Were we," remarks B. A. Behrend, distinguished author and engineer, "to seize and to eliminate the results of Mr. Tesla's work, the wheels of industry would cease to turn, our electric cars and trains would stop, our towns would be dark, our mills would be dead and idle."

Forecasting is perilous. No man can look very far into the future. Progress and invention evolve in directions other than those anticipated. Such has been my experience, although I may flatter myself that many of the developments which I forecast have been verified by events in the first third of the twentieth century.

It seems that I have always been ahead of my time. I had to wait nineteen years before Niagara was harnessed by my system, fifteen years before the basic inventions for wireless which I gave to the world in 1893 were applied universally. I announced the cosmic ray and my theory of radio activity in 1896. One of my most important discoveries--terrestrial resonance--which is the foundation of wireless power transmission and which I announced in 1899, is not understood even today. Nearly two years after I had flashed an electric current around the globe, Edison, Steinmetz, Marconi, and others

declared that it would not be possible to transmit even signals by wireless across the Atlantic. Having anticipated so many important developments, it is not without assurance that I attempt to predict what life is likely to be in the twenty-first century.

Life is and will ever remain an equation incapable of solution, but it contains certain known factors. We may definitely say that it is a movement even if we do not fully understand its nature. Movement implies a body which is being moved and a force which propels it against resistance. Man, in the large, is a mass urged on by a force. Hence the general laws governing movement in the realm of mechanics are applicable to humanity.

There are three ways by which the energy which determines human progress can be increased: First, we may increase the mass. This, in the case of humanity, would mean the improvement of living conditions, health, eugenics, etc. Second, we may reduce the frictional forces which impede progress, such as ignorance, insanity, and religious fanaticism. Third, we may multiply the energy of the human mass by enchainning the forces of the universe, like those of the sun, the ocean, the winds and tides.

The first method increases food and well-being. The second tends to bring peace. The third enhances our ability to work and to achieve. There can be no progress that is not constantly directed toward increasing well-being, peace, and achievement. Here the mechanistic conception of life is one with the teachings of Buddha and the Sermon on the Mount.

While I am not a believer in the orthodox sense, I commend religion, first, because every individual should have some ideal--religious, artistic, scientific, or humanitarian--to give significance to his life. Second, because all the great religions contain wise prescriptions relating to the conduct of life, which hold good now as they did when they were promulgated.

There is no conflict between the ideal of religion and the ideal of science, but science is opposed to theological dogmas because science is founded on fact. To me, the universe is simply a great machine which never came into being and never will end. The human being is no exception to the natural order. Man, like the universe, is a machine. Nothing enters our minds or determines our actions which is not directly or indirectly a response to stimuli beating upon our sense organs from without. Owing to the similarity of our construction and the sameness of our environment, we respond in like manner to similar stimuli, and from the concordance of our reactions, understanding is born. In the course of ages, mechanisms of infinite complexity are developed, but what we call "soul " or "spirit," is nothing more than the sum of the functioning of the body. When this functioning ceases, the "soul" or the "spirit" ceases likewise.

I expressed these ideas long before the behaviorists, led by Pavlov in Russia and by Watson in the United States, proclaimed their new psychology. This apparently mechanistic conception is not antagonistic to an ethical conception of life. The acceptance by mankind at large of these tenets will not destroy religious ideals. Today Buddhism and Christianity are the greatest religions both in number of disciples and in importance. I believe that the essence of both will be the religion of the human race in the twenty-first century.

The year 2100 will see eugenics universally established. In past ages, the law governing the survival of

the fittest roughly weeded out the less desirable strains. Then man's new sense of pity began to interfere with the ruthless workings of nature. As a result, we continue to keep alive and to breed the unfit. The only method compatible with our notions of civilization and the race is to prevent the breeding of the unfit by sterilization and the deliberate guidance of the mating instinct. Several European countries and a number of states of the American Union sterilize the criminal and the insane. This is not sufficient. The trend of opinion among eugenists is that we must make marriage more difficult. Certainly no one who is not a desirable parent should be permitted to produce progeny. A century from now it will no more occur to a normal person to mate with a person eugenically unfit than to marry a habitual criminal.

Hygiene, physical culture will be recognized branches of education and government. The Secretary of Hygiene or Physical Culture will be far more important in the cabinet of the President of the United States who holds office in the year 2035 than the Secretary of War. The pollution of our beaches such as exists today around New York City will seem as unthinkable to our children and grandchildren as life without plumbing seems to us. Our water supply will be far more carefully supervised, and only a lunatic will drink unsterilized water.

More people die or grow sick from polluted water than from coffee, tea, tobacco, and other stimulants. I myself eschew all stimulants. I also practically abstain from meat. I am convinced that within a century coffee, tea, and tobacco will be no longer in vogue. Alcohol, however, will still be used. It is not a stimulant but a veritable elixir of life. The abolition of stimulants will not come about forcibly. It will simply be no longer fashionable to poison the system with harmful ingredients. Bernarr Macfadden has shown how it is possible to provide palatable food based upon natural products such as milk, honey, and wheat. I believe that the food which is served today in his penny restaurants will be the basis of epicurean meals in the smartest banquet halls of the twenty-first century.

There will be enough wheat and wheat products to feed the entire world, including the teeming millions of China and India, now chronically on the verge of starvation. The earth is bountiful, and where her bounty fails, nitrogen drawn from the air will refertilize her womb. I developed a process for this purpose in 1900. It was perfected fourteen years later under the stress of war by German chemists.

Long before the next century dawns, systematic reforestation and the scientific management of natural resources will have made an end of all devastating droughts, forest fires, and floods. The universal utilization of water power and its long-distance transmission will supply every household with cheap power and will dispense with the necessity of burning fuel. The struggle for existence being lessened, there should be development along ideal rather than material lines.

Today the most civilized countries of the world spend a maximum of their income on war and a minimum on education. The twenty-first century will reverse this order. It will be more glorious to fight against ignorance than to die on the field of battle. The discovery of a new scientific truth will be more important than the squabbles of diplomats. Even the newspapers of our own day are beginning to treat scientific discoveries and the creation of fresh philosophical concepts as news. The newspapers of the twenty-first century will give a mere "stick" in the back pages to accounts of crime or political controversies, but will headline on the front pages the proclamation of a new scientific hypothesis.

"It will be possible to destroy anything approaching within 200 miles. My invention will provide a wall of power," declares Tesla.

Progress along such lines will be impossible while nations persist in the savage practice of killing each other off. I inherited from my father, an erudite man who labored hard for peace, an ineradicable hatred of war. Like other inventors, I believed at one time that war could be stopped by making it more destructive. But I found that I was mistaken. I underestimated man's combative instinct, which it will take more than a century to breed out. We cannot abolish war by outlawing it. We cannot end it by disarming the strong. War can be stopped, not by making the strong weak but by making every nation, weak or strong, able to defend itself.

Hitherto all devices that could be used for defense could also be utilized to serve for aggression. This nullified the value of the improvement for purposes of peace. But I was fortunate enough to evolve a new idea and to perfect means which can be used chiefly for defense. If it is adopted, it will revolutionize the relations between nations. It will make any country, large or small, impregnable against armies, airplanes, and other means for attack. My invention requires a large plant, but once it is established it will be possible to destroy anything, men or machines, approaching within a radius of 200 miles. It will, so to speak, provide a wall of power offering an insuperable obstacle against any effective aggression.

If no country can be attacked successfully, there can be no purpose in war. My discovery ends the menace of airplanes or submarines, but it insures the supremacy of the battleship, because battleships may be provided with some of the required equipment. There might still be war at sea, but no warship could successfully attack the shore line, as the coast equipment will be superior to the armament of any battleship.

I want to state explicitly that this invention of mine does not contemplate the use of any so-called "death rays." Rays are not applicable because they cannot be produced in requisite quantities and diminish rapidly in intensity with distance. All the energy of New York City (approximately two million horsepower) transformed into rays and projected twenty miles, could not kill a human being, because, according to a well known law of physics, it would disperse to such an extent as to be ineffectual.

My apparatus projects particles which maybe relatively large or of microscopic dimensions, enabling us to convey to a small area at a great distance trillions of times more energy than is possible with rays of any kind. Many thousands of horsepower can thus be transmitted by a stream thinner than a hair, so that nothing can resist. This wonderful feature will make it possible, among other things, to achieve undreamed-of results in television, for there will be almost no limit to the intensity of illumination, the size of the picture, or distance of projection.

I do not say that there may not be several destructive wars before the world accepts my gift. I may not live to see its acceptance. But I am convinced that a century from now every nation will render itself immune from attack by my device or by a device based upon a similar principle.

At present we suffer from the derangement of our civilization because we have not yet completely adjusted ourselves to the machine age. The solution of our problems does not lie in destroying but in

mastering the machine.

Innumerable activities still performed by human hands today will be performed by automatons. At this very moment scientists working in the laboratories of American universities are attempting to create what has been described as a "thinking machine." I anticipated this development.

I actually constructed "robots." Today the robot is an accepted fact, but the principle has not been pushed far enough. In the twenty-first century the robot will take the place which slave labor occupied in ancient civilization. There is no reason at all why most of this should not come to pass in less than a century, freeing mankind to pursue its higher aspirations.

And unless mankind's attention is too violently diverted by external wars and internal revolutions, there is no reason why the electric millennium should not begin in a few decades.

amazon.com
and you're done.™

**Shop
Now &
Save**

[Click here](#)

[Privacy Information](#)

- [Electronics](#)
- [Books](#)
- [Music](#)
- [DVD](#)
- [Video](#)
- [Toys & Games](#)
- [Today's Deals](#)
- [Kitchen & Housewares](#)
- [Tools & Hardware](#)
- [Computer & Video Games](#)
- [Outdoor Living](#)
- [Apparel & Accessories](#)
- [Camera & Photo](#)
- [More...](#)

[[INDEX](#)]



THE WONDER WORLD TO BE CREATED BY ELECTRICITY

Manufacturer's Record, September 9, 1915

by Dr. Nikola Tesla

Whoever wishes to get a true appreciation of the greatness of our age should study the history of electrical development. There he will find a story more wonderful than any tale from Arabian Nights. It begins long before the Christian era when Thales, Theophrastus and Pliny tell of the magic properties of electron - the precious substance we call amber - that came from the pure tears of the Heliades, sisters of Phaeton, the unfortunate youth who attempted to run the blazing chariot of Phoebus and nearly burned up the earth. It was but natural for the vivid imagination of the Greeks to ascribe the mysterious manifestations to a hyperphysical cause, to endow the amber with life and with a soul.

Whether this was actual belief or merely poetic interpretation is still a question. When at this very day many of the most enlightened people think that the pearl is alive, that it grows more lustrous and beautiful in the warm contact of the human body. So too, it is the opinion of men of science that a crystal is a living being and this view is being extended to embrace the entire physical universe since Prof. Jagadis Chunder Bose has demonstrated, in a series of remarkable experiments, that inanimate matter responds to stimuli as plant fiber and animal tissue.

The superstitious belief of the ancients, if it existed at all, can therefore not be taken as a reliable proof of their ignorance, but just how much they knew about electricity can only be conjectured. A curious fact is that the ray or torpedo fish, was used by them in electro-therapy. Some old coins show twin stars, or sparks, such as might be produced by a galvanic battery. The records, though scanty, are of a nature to fill us with conviction that a few initiated, at least, had a deeper knowledge of amber - phenomena. To mention one, Moses was undoubtedly a practical and skillful electrician far in advance of his time. The Bible describes precisely and minutely arrangements constituting a machine in which electricity was generated by friction of air against silk curtains and stored in a box constructed like a condenser. It is very plausible to assume that the sons of Aaron were killed by a high tension discharge and that the vestal fires of the Romans were electrical. The belt drive must have been known to engineers of that epoch and it is difficult to see how the abundant evolution of static electricity could have escaped their notice. Under favorable atmospheric conditions a belt may be transformed into a dynamic generator capable of producing many striking actions. I have lighted incandescent lamps, operated motors and performed numerous other equally interesting experiments with electricity drawn from belts and stored in tin cans.

That many facts in regard to the subtle force were known to the philosophers of old can be safely concluded, the wonder is, why two thousand years elapsed before Gilbert in 1600 published his famous work, the first scientific treatise on electricity and magnetism. To an extent this long period of unproductiveness can be explained. Learning was the privilege of a few and all information was jealously guarded. Communication was difficult and slow and a mutual understanding between widely

separated investigators hard to reach. Then again, men of those times had no thought of the practical, they lived and fought for abstract principles, creeds, traditions and ideals. Humanity did not change much in Gilbert's time but his clear teachings had a telling effect on the minds of the learned. Friction machines were produced in rapid succession and experiments and observations multiplied. Gradually fear and superstition gave way to scientific in-sight and in 1745 the world was thrilled with the news that Kleist and Leyden had succeeded in imprisoning the uncanny agent in a phial from which it escaped with an angry snap and destructive force. This was the birth of the condenser, perhaps the most marvelous electrical device ever invented.

Two tremendous leaps were made in the succeeding forty years. One was when Franklin demonstrated the identity between the gentle soul of amber and the awe-inspiring belt of Jupiter; the other when Galvani and Volta brought out the contact and chemical battery, from which the magic fluid could be drawn in unlimited quantities. The succeeding forty years bore still greater fruit. Oersted made a significant advance in deflecting a magnetic needle by an electric current, Arago produced the electro-magnet, Seebeck the thermo-pile and in 1831, as the crowning achievement of all, Faraday announced that he had obtained electricity from a magnet, thus discovering the principle of that wonderful engine - the dynamo, and inaugurating a new era both in scientific research and practical application.

From that time on inventions of inestimable value have followed one another at a bewildering rate. The telegraph, telephone, phonograph and incandescent lamp, the induction motor, oscillatory transformer, Roentgen ray, Radium, wireless and numerous other revolutionary advances have been made and all conditions of existence eighty-four years which have since elapsed, the subtle agents dwelling in the living amber and loadstone have been transformed into cyclopean forces turning the wheels of human progress with ever increasing speed. This, in brief, is the fairy tale of electricity from Thales to the present day. The impossible has happened, the wildest dreams have been surpassed and the astounded world is asking: What is coming next?

ELECTRICAL POSSIBILITIES IN COAL AND IRON

Many a would-be discoverer, failing in his efforts, has felt the regret to have been born at a time when everything has been already accomplished and nothing is left to be done. This erroneous impression that, as we are advancing, the possibilities of invention are being exhausted, is not uncommon. In reality it is just the opposite. Spenser has conveyed the right idea when he likened civilization to the sphere of light which a lamp throws out in darkness. The brighter the lamp and the larger the sphere the greater is its dark boundary. It is paradoxical, yet true, to say, that the more we know the more ignorant we become in the absolute sense, for it is only through enlightenment that we become conscious of our limitations. Precisely one of the most gratifying results of intellectual evolution is the continuous opening up of new and greater prospects. We are progressing at an amazing pace, but the truth is that, even in fields most successfully exploited, the ground has only been broken. What has been so far done by electricity is nothing compared with what the future has in store. Not only this, but there are now innumerable things done in old-fashioned ways which are much inferior in economy, convenience and many other respects to the new method. So great are the advantages of the latter that whenever an opportunity presents itself the engineer advises his client to "do it electrically."

Consider, in illustration, one of the largest industries, that of coal. From this valuable mineral we chiefly

draw the sun's stored energy which is required to meet our industrial and commercial needs. According to statistical records, the output in the United States during the past year was 480,000,000 tons. In perfect engines this fuel would have been sufficient to develop 500,000,000 horse-power steadily for one year, but the squandering is so reckless that we do not get more than 5 per cent of its heating value on the average. There is an appalling waste in mining, handling, transportation, store and use of coal, which could be very much reduced through the adoption of a comprehensive electrical plan in all these operations. The market value of the yearly product would be easily doubled and an immense sum added to the revenues of the country. What is more, inferior grades, billions of tons of which are being thrown away, might be turned to profitable use.

Similar considerations apply to natural gas and mineral oil, the annual loss of which amounts to hundreds of millions of dollars. In the very near future such waste will be looked upon as criminal and the introduction of the new methods will be forced upon the owners of such properties. Here, then, is an immense field for the use of electricity in many ways, vast industries which are bound to be revolutionized through its extensive application.

To give another example, I may refer to the manufacture of iron and steel, which is carried on in this country on a scale truly colossal. During the last year, notwithstanding unfavorable business conditions, 31,000,000 tons of steel have been produced. It would lead too far to dwell on the possibilities of electrical improvements in the manufacturing processes themselves, and I will only indicate what is likely to be accomplished in using the waste gases from the coke ovens and blast furnaces to generate electricity for industrial purposes.

Since in the production of pig-iron for every ton about one ton of coke is employed, the yearly consumption of coke may be put at 31,000,000 tons. The combustion in the blast furnaces yields, per minute, 7,000,000 cubic feet of gas of a heating value of 110 B. T. units per cubic foot. Of this total, without making special provision, 4,000,000 cubic feet may be made available for power purposes. If all the heat energy of this gas could be transformed into mechanical effort, it would develop 10,389,000 horse-power. This result is impossible, but it is perfectly practicable to obtain 2,500,000 horse-power electrical energy at the terminals of the dynamos.

In the manufacture of coke approximately 9400 cubic feet of gas are evolved per ton of coal. This gas is excellent for power purposes, having an average heating value of 600 B. T. units, but very little is now used in engines, largely because of their great cost and other imperfections. A ton of coke requires about 1.32 tons of American coal; hence the total coal consumption per annum on the above basis is nearly 41,000,000 tons, which give, per minute, 733,000 cubic feet of gas. Assuming the yield of surplus or rich gas to be 333,000 cubic feet, the balance of 400,000 cubic feet could be used in gas engines. The heat contents would be, theoretically, sufficient to develop 5,660,000 horse-power, of which 1,500,000 horse-power could be obtained in the form of electric energy.

I have devoted much thought to this industrial proposition, and find that with new, efficient, extremely cheap and simple thermo-dynamic transformers not less than 4,000,000 horse-power could be developed in electric generators by utilizing the heat of these gases, which, if not entirely wasted, are only in part and inefficiently employed.

With systematic improvements and refinements much better results could be secured and an annual revenue of \$50,000,000 or more derived. The electrical energy could be advantageously used in the fixation of atmospheric nitrogen and production of fertilizers, for which there is an unlimited demand and the manufacture of which is restricted here on account of the high cost of power. I expect confidently the practical realization of the project in the very near future, and look to exceptionally rapid electrical development in this direction.

HYDRO-ELECTRIC DEVELOPMENT

Water-power offers great opportunities for novel electrical applications, particularly in the department of electro-chemistry. The harness of waterfalls is the most economical method known for drawing energy from the sun. This is due to the fact that both water and electricity are incompressible. The net efficiency of the hydro-electric process can be as high as 85 per cent. The initial outlay is generally great, but the cost of maintenance is small and the convenience offered ideal. My alternating system is invariably employed, and so far about 7,000,000 horse-power have been developed. As generally used we do not get more than six-hundredths of a horse-power per ton of coal per year. This water energy is therefore equivalent to that obtainable from an annual supply of 120,000,000 tons of coal, which is about 25 per cent of the total output in the United States. The estimate is conservative, and in view of the immense waste of coal 50 per cent may be a closer guess.

We get better appreciation of the tremendous value of this power in our economic development when we remember that, unlike fuel, which demands a terrible sacrifice of human energy and is consumed, it is supplied without effort and destruction of material and equals the mechanical performance of 150,000,000 men -- one and one-half times the entire population of this country. These figures are imposing; nevertheless, we have only begun the exploitation of this vast national resource.

There are two chief limitations at present -- one in the availability of the energy, the other in its transmission to distance. The theoretical power of the falling water is enormous. If we assume for the rain clouds an average height of 15,000 feet and annual precipitation of 33 inches, the 24 horse-power per square mile is over 4000, and for the whole area in the United States more than 12,000,000,000 horse-power. As a matter of fact, the larger portion of the potential energy is used up in air friction. This, while disappointing to the economist, is a fortunate circumstance, for otherwise the drops would reach the ground with a speed of 800 feet per second -- sufficient to raise blisters on our bodies, while hail would be positively deadly. Most of the water, which is available for power purposes comes from a height of about 2000 feet and represents over one and one-half billion horse-power, but we are only able to use an average fall of, say, 100 feet, which means that if all the water-power in this country were harnessed under the existing conditions only 80,000,000 horse-power could be obtained.

THE NEXT GREAT ACHIEVEMENT -- ELECTRICAL CONTROL OF ATMOSPHERIC MOISTURE

But the time is very near when we shall have the precipitation of the moisture of the atmosphere under complete control, and then it will be possible to draw unlimited quantities of water from the oceans, develop any desired amount of energy, and completely transform the globe by irrigation and intensive farming. A Greater achievement of man through the medium of electricity can hardly be imagined.

The present limitations in the transmission of power to distance will be overcome in two ways -- through the adoption of underground conductors insulated by power, and through the introduction of the wireless art. The first plan I have advanced years ago. The underlying principle is to convey through a tubular conductor hydrogen at a very low temperature, freeze the surrounding material and thus secure a perfect insulation by indirect use of electric energy. In this manner the power derived from falls can be transmitted to distances of hundreds of miles with the highest economy and at a small cost. This innovation is sure to greatly extend the fields of electrical application. As to the wireless method, we have now the means for economic transmission of energy in any desired amount and to distances only limited by the dimensions of this planet. In view of assertions of some misinformed experts to the effect that in the wireless system I have perfected the power of the transmitter is dissipated in all directions, I wish to be emphatic in my statement that such is not the case. The energy goes only to the place where it is needed and to no other.

When these advanced ideas are practically realized we shall get the full benefit of water-power, and it will become our chief dependence in the supply of electricity for domestic, public and other uses in the arts of peace and war.

ECONOMY IN LIGHT AND POWER -- ELECTRIC PROPULSION

In the great departments of electric light and power immense opportunities are offered through the introduction of all kinds of novel devices which can be attached to the circuits at convenient hours for the purpose of equalizing the loads and increasing the revenues from the plants. I have myself knowledge of a number of new appliances of this kind. The most important among them is probably an electrical ice machine which obviates entirely the use of dangerous and otherwise objectionable chemicals. The new machine will also require absolutely no attention and will be extremely economical in operation, so that the refrigeration will be effected very cheaply and conveniently in every household.

An interesting fountain, electrically operated, has been brought out which is likely to be extensively introduced, and will afford an unusual and pleasing sight in squares, parks, hotels and residences.

Cooking devices for all domestic purposes are being provided, and there is great demand for practical designs and suggestions in this field. The same may be stated of electric signs and other attractive means of advertising which can be electrically operated. Some of the effects which it is possible to produce by electric currents are wonderful and lend themselves to exhibitions, and there is no doubt that much can be done in that direction. Theaters, public halls and private dwellings are in need of a great many devices and instruments for convenience and offer ample opportunities to an ingenious and practical inventor.

A vast and absolutely untouched field is the use of electricity for the propulsion of ships. The leading electrical company in this country has just equipped a large vessel with high-speed turbines and electric motors and has achieved a signal success. Applications of this kind will multiply at a rapid rate, for the advantages of the electrical drive are now patent to everybody. In this connection gyroscopic apparatus will probably play an important part, as its general adoption on vessels is sure to come. Very little has yet been done in the introduction of electrical drive in the various branches of industry and manufacture, and the prospects are unlimited.

A FEW OF THE WONDERS TO COME

Books have already been written on the agricultural uses of electricity, but the fact is that hardly anything has been practically done. The beneficial effects of electricity of high tension have been unmistakably established, and a revolution will be brought about through the extensive adoption of agricultural electrical apparatus. The safeguarding of forests against fires, the destruction of microbes, insects and rodents will, in due course, be accomplished by electrical means.

In the near future we shall see a great many new uses of electricity aiming at safety, particularly vessels at sea. We shall have electrical instruments for preventing collisions, and we shall even be able to disperse fogs by electric force and powerful and penetrative rays. I am hopeful that within the next few years wireless plants will be installed for the purpose of illuminating the oceans. The project is perfectly feasible, and if carried out will contribute more than any other provision to the safety of property and human lives at sea. The same plant could also produce stationary electrical waves and enable vessels to get at any time accurate bearings and other valuable practical data without resorting to the present means. It could also be used for time signaling and many other purposes of similar nature.

Electrotherapy is another great field in which there are unlimited possibilities for electrical applications. High-frequency currents especially have a great future. The time will come when this form of electrical energy will be available in every private residence. I consider it quite possible that through their surface actions we may do away with the customary bath, as the cleaning of the body can be instantaneously effected simply by connecting it to a source of currents or electric energy of very high potential, which results in the throwing off of dust or any small particles adhering to the skin. Such a dry bath, besides being convenient and time-saving, would also be of beneficial therapeutic influence. New electric devices for use of the deaf and blind are coming and will be a blessing to the afflicted.

In the prevention of crime electrical instruments will soon become an important factor. In court proceedings electric evidence will often be decisive. In a time not distant it will be possible to flash any image formed in thought on a screen and render it visible at any place desired. The perfection of this means of reading thought will create a revolution for the better in all our social relations. Unfortunately, it is true, that cunning lawbreakers will avail themselves of such advantages to further their nefarious business.

TELEGRAPHIC PHOTOGRAPHY AND OTHER ADVANCES

Great improvements are still possible in telegraphy and telephony. The use of a new receiving device which will be shortly described, and the sensitiveness of which can be increased almost without limit, will enable telephoning through aerial lines or cables however long by reducing the necessary working current to an infinitesimal value. This invention will dispense with the necessity of resorting to expensive constructions, which, however, are of circumscribed usefulness. It will also enormously extend the wireless transmission of intelligence in all its departments.

The next art to be inaugurated is that of picture transmission by ordinary telegraphic methods and existing apparatus. This idea of telegraphing or telephoning pictures is old, but practical difficulties

have hampered commercial realizations. A number of improvements of great promise have been made, and there is every reason to expect that success will soon be achieved.

Another valuable novelty will be a typewriter electrically operated by the human voice. This advance will fill a long-felt want, as it will do away with the operator and save a great deal of labor and time in offices.

A new and extremely simple electric tachometer is being prepared for the market, and it is expected that it will prove useful in power plants and central stations, on boats, locomotives and automobiles.

Many municipal improvements based on the use of electricity are about to be introduced. We have soon to have everywhere smoke annihilators, dust absorbers, ozonizers, sterilizers of water, air, food and clothing, and accident preventers on streets, elevated roads and in subways. It will become next to impossible to contract disease germs or get hurt in the city, and country folk will get to town to rest and get well.

ELECTRIC INVENTIONS IN WAR

The present international conflict is a powerful stimulus to invention of devices and implements of warfare. An electric gun will soon be brought out. The wonder is that it was not produced long ago. Dirigibles and aeroplanes will be equipped with small electric generators of high tension, from which the deadly currents will be conveyed through the wires to the ground. Battleships and submarines will be provided with electric and magnetic feelers so delicate that the approach of any body underwater or in darkness will be detected. Torpedoes and floating mines are almost in sight which will direct themselves automatically and without fail get in fatal contact with the object to be destroyed. The art of telautomatics, or wireless control of automatic machines at a distance, will play a very important part in future wars and, possibly, in the next phases of the present one. Such contrivances which act as if endowed with intelligence will be used in innumerable ways for attack as well as defense. They may take the shape of aeroplanes, balloons, automobiles, surface or under-water boats, or any other form according to the requirement in each special case, and will be of greater range and destructiveness than the implements now employed. I believe that the telautomatic aerial torpedo will make the large siege gun, on which so much dependence is placed at present, obsolete.

A volume might be filled with such suggestions without exhausting the possibilities. The advance even under the conditions existing is rapid enough, but when the wireless transmission of energy for general use becomes a practical fact the human progress will assume the character of a hurricane. So all-surpassing is the importance of this marvelous art to the future existence and welfare of the human race that every enlightened person should have a clear idea of the chief factors bearing on its development.

THE POWER OF THE FUTURE

We have at our disposal three main sources of life-sustaining energy -- fuel, water-power and the heat of the sun's rays. Engineers often speak of harnessing the tides, but the discouraging truth is that the tidewater over one acre of ground will, on the average, develop only one horse-power. Thousands of

mechanics and inventors have spent their best efforts in trying to perfect wave motors, not realizing that the power so obtained could never compete with that derived from other sources. The force of wind offers much better chances and is valuable in special instances, but is by far inadequate. Moreover, the tides, waves and winds furnish only periodic and often uncertain power and necessitate the employment of large and expensive storage plants. Of course, there are other possibilities, but they are remote, and we must depend on the first of three resources. If we use fuel to get our power, we are living on our capital and exhausting it rapidly. This method is barbarous and wantonly wasteful, and will have to be stopped in the interest of coming generations. The heat of the sun's rays represents an immense amount of energy vastly in excess of water-power. The earth receives an equivalent of 83 foot-pounds per second for each square foot on which the rays fall perpendicularly. From simple geometrical rules applying to a spherical body it follows that the mean rate per square foot of the earth's surface is one-quarter of that, or 20 3/4 foot-pounds. This is to say over one million horse-power per square mile, or 250 times the water-power for the same area. But that is only true in theory; the practical facts put this in a different aspect. For instance, considering the United States, and taking into account the mean latitude, the daily variation, the diurnal changes, the seasonal variations and casual changes, this power of the sun's rays reduces to about one-tenth, or 100,00 horse-power per square mile, of which we might be able to recover in high-speed low-pressure turbines 10,000 horse-power. To do this would mean the installment of apparatus and storage plants so large and expensive that such a project is beyond the pale of the practical. The inevitable conclusion is that water-power is by far our most valuable resource. On this humanity must build its hopes for the future. With its full development and a perfect system of wireless transmission of the energy to any distance man will be able to solve all the problems of material existence. Distance, which is the chief impediment to human progress, will be completely annihilated in thought, word and action. Humanity will be united, wars will be made impossible and peace will reign supreme.

[[INDEX](#)]

[HOME](#)

[NIKOLA TESLA PAGE](#)



TESLA: Free Energy- The Tunguska Explosion

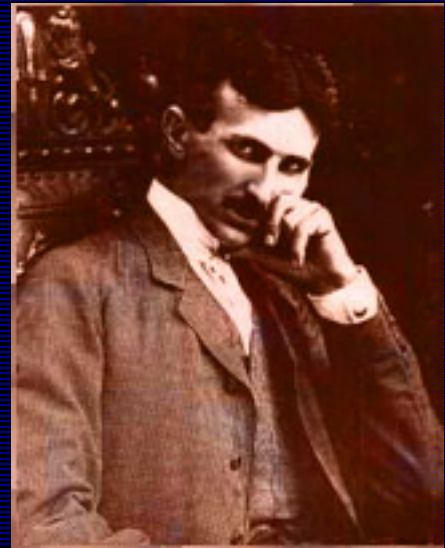

In the 1880's, Nikola Tesla invented the alternating current system we use today. By the 1890's, he was working on a new type of electrical generator that would not, as he said, "consume any fuel."

[My first paper](#), Tesla's Fuelless Generator, prepared for the 1991 Intersociety Energy Conversion Engineering Conference, documents where in his writings the description of this new generator is found, provides a theory of how a fuelless generator could work and suggests how Tesla's new device might have operated.

[My second paper](#), Physics of the Fuelless Generator, for the 1993 IECEC, argues that the fuelless generator follows the Second Law of Thermodynamics - that it is not an "over unity" device putting out more energy that it takes in. The new generator performs little work and expends little energy, in the sense that physics uses those terms, while powering a device.

[My third paper](#), Tesla Wireless And The Tunguska Explosion, looks at the many references Tesla made to the use of his wireless power transmission technology as a directed energy weapon. Tesla's statements are examined in their relationship to the Tunguska explosion of 1908 that may have been a test firing of his energy weapon.

Compliments: Dr. Oliver Nichol森,
email:onichelson@post.harvard.edu

Used by exclusive permission.

amazon.com
and you're done.™

**Shop
Now &
Save**

[Click here](#)

[Privacy Information](#)

- [Electronics](#)
- [Books](#)
- [Music](#)
- [DVD](#)
- [Video](#)
- [Toys & Games](#)
- [Today's Deals](#)
- [Kitchen & Housewares](#)
- [Tools & Hardware](#)
- [Computer & Video Games](#)
- [Outdoor Living](#)
- [Apparel & Accessories](#)
- [Camera & Photo](#)
- [More...](#)

Contents

- [Tesla's Fuelless Generator](#)
- [Physics of the Fuelless Generator](#)
- [Tesla Wireless and the Tunguska Explosion](#)

shop now
AND SAVE
Save big on thousands of products!

Computers
Books
Music
DVDs

amazon.com
and you're done.™
[Click Here](#)

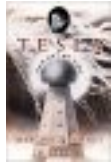

[Tesla](#)

Margaret Cheney
New \$10.20!
Used \$5.75!



[My Inventions](#)

Ben Johnston
New \$9.95!



[In Search of Nikola Tesla](#)

F. David Peat
New \$10.47!
Used \$8.36!



[The Fantastic Inventions of Nikola T...](#)

Nikola Tesla
New \$11.53!
Used \$10.20!



[Tesla](#)

George Trinkaus
New \$7.75!

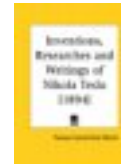

[Inventions, Researches and Writings ...](#)

Thomas C. Martin
New \$25.80!
Used \$18.99!



[Wizard](#)

Marc J. Seifer
New \$13.57!
Used \$11.97!



[Nikola Tesla's Earthquake Machine](#)

Dale Pond
New \$14.41!
Used \$10.39!

[My Inventions](#)

Nikola Tesla
New \$12.95!
Used \$9.95!

(Prices May Change)

[Privacy Information](#)

Copies of these papers and other articles on Tesla, including a reproduction of the letter in which Tesla claims the invention of a generator that would not "consume any fuel," are available from:

Planetary Association for Clean Energy
100 Bronson Avenue, Suite 1001
Ottawa, Ontario K1R 6G8 CANADA
Voice: 613-236-6265, Fax: 613-235-5876

Links

Compliments: Dr. Oliver Nichol森,
email:onichelson@post.harvard.edu

Oliver Nichelson
333 North 760 East
American Fork, Utah 84003

© Copyright 1995
used by permission.

Books on Tesla, including these papers, are available at 21st Century Books: <http://www.tfcbooks.com/>

Listings of all books on Nikola Tesla, are available at "[The Nikola Tesla and Viktor Schauburger Bookstore](#)"



Tesla's "Black Box"

The following recital on Tesla's work with Radiant Energy is an excerpt from the book, *Secrets of Cold War Technology* by Gerry Vassilatos, pages 86-93.

The "fountain effects" which surrounded his station are not responsible for the ever-growing power observed by Tesla. This was the result of an incoming aetheric supply for which his Transmitter gave low-resistance passage. The incoming aetheric flow preferred the transmitter terminal to adjacent, more resistant rock. This gradual flow process soon evidenced itself in magnification effects, ever increasing volumes of flowing aether being measured in his system. Some have argued that Tesla merely stored energy in the earth, extracting it for use later. This is a basic error, the result of imagining the Colorado Springs experiment to be one consisting entirely of electrical effects (Grotz). It is in this light alone that we may comprehend the evident anomalous magnification of aetheric phenomena in his Colorado Springs photographs.

Once aetheric energy had been obtained from space, it had to be conveyed to consumers. Tesla had arranged for the automatic activation of aether-rebroadcast circuits in the station. The down pouring aether was automatically shunted to side circuits through capacitors. In these side branches, aether pulsed through dielectrics and expanded over the surfaces of his smaller coils. Thus stimulated to more rapid pulsation rates, they were ready for "rebroadcast". Being rebroadcast away from the station through large vacuum globes, poised on elevated platforms, these were the aetheric pulsations, which would be utilized in home and industry. Simple and compact receivers would be established in every home and factory, set to receive aetheric current through the ground. Tests were thrilling. The distant appliances, lamps and motors responded to the powerful pulsations, as if they were physically connected to the station by wire. A small house-like structure was established some 26 miles away from the station. In it, an aetheric power receiver was tuned to one of the rebroadcast rates. The 200 lamps housed within this structure, each of 50 watts rating, all remained brilliantly illuminated throughout the test runs. This apparently stimulated enough excitement and concern for word of this development to get back east.

Engineers were enraged. Those who had missed his most early shift from alternations to impulses, failed to comprehend the vast distinction between "stationary waves" and "standing waves". The quizzical use of specific terms such as these was a Tesla trademark, one designed to puzzle the minds of those who criticized him the most. With the exception of a very few colleagues who continually made related discoveries in aether physics, most academes had chosen to remain totally ignorant of the new study area. This for example was the case with the Teslian use of the term "frequency" and of "resonance" words which had completely different meanings for Tesla. Teslian "frequency" refers to the repetition of pulses per second. Teslian "resonance" refers to conditions in which aether flows with little or no resistance through systems, whether proximal or widely separated.

Photographs, which Tesla sent to his "financiers", were analyzed and reexamined repeatedly for their

encrypted meaning. None could decipher the cunning puzzle which Tesla had set before them. Tesla stated that photographs of the aetheric white fire streamers required several minutes' exposure time before registering the faintest sort of impression. Most of the plates were therefore the results of more than 20 minutes' exposure time. There are a very few plates which, though stated to be the result of "one brief switch closure", are covered with dense, thick white streamers. One fraction of a second closure on the system switch resulted in a twenty-minute or more aether avalanche. Magnifying Transformers continued discharging long after the initial impulse had been withdrawn.

AETHER POWER RECEIVERS

Tesla returned to New York exultant. He was about to establish a new world precedent. Venture capitalists were everywhere, looking for their opportunity to enter the "new energy" market. Unknown to Tesla, his station, its tower, the large coils, the capacitors, and all the other marvelous apparatus, which demonstrated free aetheric power to the world, had been acquired for demolition. Tesla simply went forward, securing new funds from Morgan and others toward the development of a fully functional industry sized station in Long Island. Wardencllyffe Station. Wardencllyffe would be his greatest achievement. Here he would broadcast power to the world, along with a communications network, which could span the globe with innumerable available channels. Aether wave communications. Several stations would augment the power of this first station, from which he proposed to rebroadcast 10,000horsepower. The Station, a wonderful visionary structure, which dominated the view of Shoreham, Long Island, was not quite complete before it too was seized by court injunctions and torn down.

Tesla was summoned to appear in court. Mr. Leland Anderson who has since published a wonderful treatise with this transcript as the centerpiece has secured the amazing transcript of this proceeding. Tesla said he wept when he saw the ruined tower at Wardencllyffe. The train ride back from Shoreham was filled with tears and the recounting of every tragedy, which marked his life. But the dreams did not die there. In the absence of financial means to construct his gigantic stations, Tesla found ways to build small systems, which accomplished the very same objectives. Replacing the large overhead capacity terminal with material substitutes, radioactive metals in combination with other dense elements, Tesla was able to accrete and focus aether pulsations of super short duration.

Tesla was then plunged into a hellish time, where all but one would neither help nor hear him. Dr. John Hammond requested Tesla to be the permanent guest on his family estate. There, amid the family life of Hammond Castle, Tesla shared his dreams and technology. Together, he and Dr. Hammond developed the science of robots and remote guidance. Tesla, impoverished by the inhuman treatment wrought on him by the financial establishment, was nonetheless quite alive and valuable to those having singular ambition to dominate the world radio trade. For a very long time, Nikola Tesla was considered "out of circulation."

But later years turned a kindlier edge toward him. Long after his principle foe had died, other sought him out. Employed by the Rockefellers in their RCA venture, Tesla was given the task of restructuring

the now failing Marconi System. David Sarnoff did not permit Tesla the dignity of working under his own name! Nevertheless it was Tesla, not Sarnoff, who redesigned the insufficient RCA radio systems to sufficiently turn a profit for the owners. It is significant that Tesla was not allowed to change the basic design from wave radio to radiant communications. What he achieved required certain strange conversions within the wave radio circuitry, intensifying radiant signals until the operation was much improved, and then converting the amplified signals back to waves once again. All of this was achieved within the chassis, certain of which are now being studied. These Tesla experimental models are typical of the Tesla style, containing no resistors or other such components. These models use simple transmitter tubes and employ a great number of symmetrically disposed conical air coils.

While working for RCA under the name "Terbo", his mother's maiden name, Tesla maintained his two penthouse suites atop the Hotel New Yorker. One penthouse was his living quarters, the other a full-scale research laboratory. Tesla designed and built small compact and portable aether energy receivers, a developmental path, which he pursued to his passing. Tesla had long investigated the use of pure dielectric field energy, a stream of aether whose individual pulsations were so very ultra short that science had never found a means to harness the energy impulses. Tesla later held the opinion that dielectric current was composed of radiant particles, aetheric in nature. He therefore sought natural sources in which native dielectric fields could be used as they were, without the need for mammoth voltage "shocks" to stigmata aetheric currents. Tesla knew that if dielectric aether streams could be directly engaged, a true world of the future would be in his grasp. Furthermore, the mass-production of thousands and ten thousands of such power receiver would be an unstoppable army. An army of miniatures, which could never be torn down.

The implications were fathomless. Tesla had found a truly new and wonderful approach to an old problem. Once because his technology had not yet grown to the level where this was possible, he had to settle for impressing the naturally prolific aether streams with "extra" pulsations. The Transmitter method was costly, gargantuan, and an easy target for those who hated the notion of a future world where dreams rule humanity. Dielectric energy fascinated Tesla. It was everywhere, a natural emanation whose potentials far out proportioned conventional notions of power. Indeed, the early conception of natural radioactivity as an energetic source was nothing in comparison to the potential power inherent in dielectric streams. The new technology would use ultra-short pulsing aether streams, energies that occupied most of his latter press conferences in latter years. Study had convinced Tesla that the apparently smooth and native force characteristic of dielectric field energy was actually a particulate flux, a succession of ultra-short impulses. The derivation of such an impulse train would solve all energy needs for eternity with an elegance far out-reaching his own

Magnifier Transmitter

Of a truth, dielectric energy was native source of incredible proportion and virtually eternal duration. Able to use such a kinetic source, one could dispense entirely with the Power Transmitters necessary in stimulating and impressing "extra pulsations" on the aether flow. Tesla often defined the dielectric field as a natural flow of aether particles, one that seemed impossible to utilize through lack of appropriate resistive materials. In order to obtain momentum from the flowing particles of a dielectric field, one

required special matter poised in equally special symmetries. The otherwise continuous flow could be absorbed directly, being exchanged to utilities, appliances, and other applications.

Tesla had already considered the condition of charged particles, each representing a tightly constricted whorl of aether. The force necessarily exerted at close distances by such aetheric constrictions was incalculably large. Aetheric ponderance maintained particulate stability. Crystalline lattices were therefore places within which one could expect to find unexpected voltages. Indeed, the high voltages inherent in certain metallic lattices, intra-atomic field energies, are enormous. The close Coulomb gradient between atomic centers are electrostatic potentials reaching humanly unattainable levels. By comparison, the voltages, which Tesla once succeeded in releasing, were quite insignificant. In these balanced lattices, Tesla sought the voltages needed to initiate directed aetheric streams in matter. Once such a flow began, one could simply tap the stream for power. In certain materials, these aether streams might automatically produce the contaminating electrons, a source of energy for existing appliances. One could theoretically then "tailor" the materials needed to produce unexpected aetheric power with or without the attendant detrital particles. Tesla did mention the latent aetheric power of charge forces, the explosive potentials of bound aether, and the aetheric Power inherent in matter. In these studies, Tesla sought replacement for the 100,000,000 volt initiating pulses which natural law required for the implementation of space aether. Tesla had long been forced to abandon those gigantic means by other, less natural laws.

Thereafter, Tesla shifted his attentions from the appreciation of the gigantic to an appreciation of the miniature. He sought a means for proliferating an immense number of small and compact aether power receivers. With one such device, Tesla succeeded in obtaining power to drive an electric car. But for the exceptional account, which follows, we would have little information on this last period in Tesla's productive life, one that very apparently did not cease its prolific streams of creativity to his last breath. The information comes through an unlikely source, one rarely mentioned by Tesla biographers. It chanced that an aeronautical engineer, Derek Ahlers, met with one of Tesla's nephews then living in New York. Theirs was an acquaintance lasting some 10 years, consisting largely of anecdotal commentaries on Dr. Tesla. Mr. Savo provided an enormous fund of knowledge concerning many episodes in Tesla's last years.

The Black Box

Himself an Austrian military man and a trained aviator, Mr. Savo was extremely opened about certain long-cherished incidents in which his uncle's genius was consistently made manifest. Mr. Savo reported that in 1931, he participated in an experiment involving aetheric power. Unexpectedly, almost inappropriately, he was asked to accompany his uncle on a long train ride to Buffalo. A few times in this journey, Mr. Savo asked the nature of their journey. Dr. Tesla remained unwilling to disclose any information, speaking rather directly to this issue. Taken into a small garage, Dr. Tesla walked directly to a Pierce Arrow, opened the hood and began making a few adjustments. In place of the engine, there was an AC motor. This measured a little more than 3 feet long, and a little more than 2 feet in diameter. From it trailed two very thick cables, which connected with the dashboard. In addition, there was an ordinary 12-volt storage battery. The motor was rated at 80 horsepower. Maximum rotor speed was

stated to be 30 turns per second. A 6-foot antenna rod was fitted into the rear section of the car.

Dr. Tesla stepped into the passenger side and began making adjustments on a "power receiver" which had been built directly into the dashboard. The receiver, no larger than a short-wave radio of the day, used 12 special tubes, which Dr. Tesla brought with him in a box-like case. Mr. Savo told Mr. Ahler that Dr. Tesla built the receiver in his hotel room, a device 2 feet in length, nearly 1 foot wide, a 122 foot high. These curiously constructed tubes having been properly installed in their sockets, Dr. Tesla pushed in 2 contact rods and informed Mr. Savo that power was now available to drive. Several additional meters read values, which Dr. Tesla would not explain. No sound was heard. Dr. Tesla handed Mr. Savo the ignition key and told him to start the engine, which he promptly did. Yet hearing nothing, the accelerator was applied, and the car instantly moved. Tesla's nephew drove this vehicle without other fuel for an undetermined long interval. Mr. Savo drove a distance of 50 miles through the city and out to the surrounding countryside. The car was tested to speeds of 90 mph, with the speedometer rated to 120.

After a time, and with increasing distance from the city itself, Dr. Tesla felt free enough to speak. Having now become sufficiently impressed with the performance of both his device and the automobile. Dr. Tesla informed his nephew that the device could not only supply the needs of the car forever, but could also supply the needs of a household "with power to spare". When originally asked how the device worked, Tesla was initially adamant and refused to speak. Many who have read this "apocryphal account" have stated it to be the result of an "energy broadcast". This misinterpretation has simply caused further confusions concerning this stage of Tesla's work. He had very obviously succeeded in performing, with this small and compact device, what he had learned in Colorado and Shoreham.

As soon as they were on the country roads, clear of the more congested areas, Tesla began to lecture on the subject. Of the motive source he referred to "a mysterious radiation, which comes out of the aether". The small device very obviously and effectively appropriated this energy. Tesla also spoke very glowingly of this providence, saying of the energy itself that "it is available in limitless quantities". Dr. Tesla stated that although "he did not know where it came from, mankind should be very grateful for its presence". The two remained in Buffalo for 8 days, rigorously testing the car in the city and countryside. Dr. Tesla also told Mr. Savo that the device would soon be used to drive boats, planes, trains, and other automobiles. Once, just before leaving the city limits, they stopped at a streetlight and a bystander joyfully commented concerning their lack of exhaust fumes. Mr. Savo spoke up whimsically, saying that they had "no engine". They left Buffalo and traveled to a predetermined location, which Dr. Tesla knew, an old farmhouse barn some 20 miles from Buffalo. Dr. Tesla and Mr. Savo left the car in this barn, took the 12 tubes and the ignition key, and departed.

Later on, Mr. Savo heard a rumor that a secretary had spoken candidly about both the receiver and the test run, being promptly fired for the security breach. About a month after the incident, Mr. Savo received a call from a man who identified himself as Lee De Forest, who asked how he enjoyed the car. Mr. Savo expressed his joy over the mysterious affair, and Mr. DeForest declared Tesla the greatest living scientist in the world. Later, Mr. Savo asked his uncle whether or not the power receiver was being used in other applications. He was informed that Dr. Tesla had been negotiating with a major

shipbuilding company to build a boat with a similarly outfitted engine. Asked additional questions, Dr. Tesla became annoyed. Highly concerned and personally strained over the security of this design, it seems obvious that Tesla was performing these tests in a desperate degree of secrecy for good reasons. Tesla had already been the victim of several manipulations, deadly actions entirely sourced in a single financial house. For this reason, secrecy and care had become his only recent excess. Below is the actual book, offered through Amazon.com...it is a very, very good read. FDG.

[Secrets of Cold War Technology: Project HAARP and Beyond](#), by Gerry Vassilatos,
Our Price: \$15.95 Now, Free Shipping!



Editorial Reviews



Book Description: In *Secrets of Cold War Technology*, Gerry Vassilatos reveals that "Death Ray" technology has been secretly researched and developed since the turn of the century. Included are chapters on H. C. Vion, the developer of auroral energy receivers; Dr. Selim Lemstrom's pre-Tesla experiments; the early beam weapons of Grindell-Mathews; John Hettenger and his early beam power systems; Ulivi Turpain and others. Learn about Project Argus, Project Teak and Project Orange; EMP experiments back in the '60s; why the Air Force directed the construction of a huge ionospheric "backscatter" telemetry system across the Pacific just after World War II; why Raytheon has collected every patent relevant to HAARP over the past few years; and much more pertinent information on hidden Cold War technology.

About the Author: Gerry Vassilatos is a high school science teacher who lives in New York City. He is the author of *The Lost Science*, another forthcoming book from Adventures Unlimited.

Let's continue to explore...here is yet another view of Tesla's mysterious "black box" presented from a file from "Keeleynet.COM" @ <http://www.keeleynet.com>

Click here to view Keeleynet's "Tesla's Mysterious Black Box" files: [TESLAFE1.ASC](#) this link is outside of Frank.Germano.com.

Note: We at International Turbine And Power, LLC do not endorse these schematics, however, it is our opinion that, if constructed properly, and with the proper sending unit (i.e.: a Tesla Coil nearby, or, as Tesla probably used - a "magnifying transmitter") this device would in fact, collect and supply energy to a device. Used by permission: Keely Net, <http://www.keelynet.com>.

Please see [John Bedini's](#) page (a link) for a complete schematic of the Tesla Black Box, and for working devices.

[[INDEX](#)]



THE GREATEST HACKER OF ALL TIME

The question comes up from time to time. "Who's the greatest hacker ever? "Well, there's a lot of different opinions on this. Some say Steve Wozniak of Apple II fame. Maybe Andy Hertzfeld of the Mac operating system...Richard Stallman, say others, of MIT. Yet at such times when I mention who I think the greatest hacker is, everyone agrees (provided they know of him), and there's no further argument. So, let me introduce you to him, and his greatest hack. I'll warn you right up front that it's mind numbing. By the way, everything I'm going to tell you is true and verifiable down at your local library. Don't worry; we're not heading off into a Shirley MacLaine UFO-land story. Just some classy electrical engineering...

THE SCENE: COLORADO SPRINGS, CO.

Colorado Springs is in southern Colorado, about 70 mile south of Denver. These days it is known as the home of several optical disk research corporations and of NORAD, the missile defense command under Cheyenne Mountain. (I have a personal interest in Colorado Springs; my wife Sandy grew up there.) These events took place some time ago in Colorado Springs. A scientist had moved into town and set up a laboratory on Hill Street, on the southern outskirts. The lab had a two hundred foot copper antenna sticking up out of it, looking something like a HAM radio enthusiast's antenna. He moved in and started work. And strange electrical things happened near that lab.

People would walk near the lab, and sparks would jump up from the ground to their feet, through the soles of their shoes. One boy took a screwdriver, held it near a fire hydrant, and drew a four inch electrical spark from the hydrant. Sometimes the grass around his lab would glow with an eerie blue corona, St. Elmo's Fire. What they didn't know was this was small stuff. The man in the lab was merely tuning up his apparatus. He was getting ready to run it wide open in an experiment that ranks as among the greatest, and most spectacular, of all time. One side effect of his experiment was the setting of the record for man-made lightning: some 42 meters in length (130 feet).

THE MAN: NIKOLA TESLA.

His name was [Nikola Tesla](#). He was an immigrant from what is now Yugoslavia; there's a museum of his works in Belgrade. He's virtual unknown in the United States, despite his accomplishments. I'm not sure why. Some people feel it's a darn plot, the same people who are into conspiracy theories. I feel it's more that Tesla, while a brilliant inventor, was also an awful businessman; he ended up going broke. Businessmen who go broke fade out of the public eye; we see this in the computer industry all the time. Edison, who wasn't near the inventor Tesla was, but who was a better businessman, is well remembered as is his General Electric. Still, let me list a few of Tesla's works just so you'll understand how bright he was. He invented the AC motor and transformer. (Think of every motor in your house.) He invented 3-phase electricity and popularized alternating current, the electrical distribution system used all over the world.

He invented the Tesla Coil, which makes the high voltage that drives the picture tube in your computer's CRT. He is now credited with inventing modern radio as well; the Supreme Court overturned Marconi's patent in 1943 in favor of Tesla.

Tesla, in short, invented much of the equipment that gets power to your home every day from miles away, and many that use that power inside your home. His inventions made George Westinghouse (Westinghouse Corp.) a wealthy man. Finally, the unit of magnetic flux in the metric system is the "tesla". Other units include the "faraday" and the "henry", so you'll understand his is an honor given to few. So we're not talking about an unknown here, but rather a solid electrical engineer. Tesla whipped through a number of inventions early in his life. He found himself increasingly interested in resonance, and in particular, electrical resonance. Tesla found out something fascinating. If you set an electrical circuit to resonating, it does strange things indeed. Take for instance his Tesla Coil. This high frequency step-up transformer would kick out a few hundred thousand volts at radio frequencies. The voltage would come off the top of his coil as a "corona", or brush discharge. The little ones put out a six-inch spark; the big ones throw sparks many feet long. Yet Tesla could draw the sparks to his fingers without being hurt -- the high frequency of the electricity keeps it on the surface of the skin, and prevents the current from doing any harm. Tesla got to thinking about resonance on a large scale. He'd already pioneered the electrical distribution system we use today, and that's not small thinking; when you think of Tesla, think big. He thought, let's say I send an electrical charge into the ground. What happens to it? Well, the ground is an excellent conductor of electricity.

Let me spend a moment on this so you understand, because topsoil doesn't seem very conductive to most. The ground makes a wonderful sinkhole for electricity. This is why you "ground" power tools; the third (round) pin in every AC outlet in your house is wired straight to, literally, the ground. Typically, the handle of your power tool is hooked to ground this way, if something shorts out in the tool and the handle gets electrified, the current rushes to the ground instead of into you. The ground has long been used in this manner, as a conductor. Tesla generates a powerful pulse of electricity, and drains it into the ground. Because the ground is conductive, it doesn't stop. Rather, it spreads out like a radio wave, traveling at the speed of light, 186,000 miles per second. And it keeps going, because it's a powerful wave; it doesn't peter out after a few miles. It passes through the iron core of the earth with little trouble. After all, molten iron is very conductive. When the wave reaches the far side of the planet, it bounces back, like a wave in water bounces when it reaches an obstruction. Since it bounces, it makes a return trip; eventually, it returns to the point of origin. Now, this idea might seem wild.

But it isn't science fiction. We bounced radar beams off the moon in the 1950's, and we mapped Venus by radar in the 1970's. Those planets are millions of miles away. The earth is a mere 3000 miles in diameter; sending an electromagnetic wave through it is a piece of cake. We can sense earthquakes all the way across the planet by the vibrations they set up that travel all that distance. So, while at first thought it seems amazing, it's really pretty straight forward. But, as I said, it's a typical example of how Tesla thought. And then he had one of his typically Tesla ideas. He thought, when the wave returns to me (about 1/30th of a second after he sends it in), it's going to be considerably weakened by the trip. Why doesn't he send in another charge at

this point, to strengthen the wave? The two will combine, go out, and bounce again. And then he'll reinforce it again, and again. The wave will build up in power. It's like pushing a swing set. You give a series of small pushes each time the swing goes out. And you build up a lot of power with a series of small pushes; ever tried to stop a swing when it's going full tilt? He wanted to find out the upper limit of resonance. And he was in for a surprise.

THE HACK: THE TESLA COIL

So Tesla moved into Colorado Springs, where one of his generators and electrical systems had been installed, and set up his lab. Why Colorado Springs? Well, his lab in New York had burned down, and he was depressed about that. And as fate would have it, a friend in Colorado Springs who directed the power company, Leonard Curtis, offered him free electricity. Who could resist that? After setting up his lab, he tuned his gigantic Tesla coil through that year, trying to get it to resonate perfectly with the earth below. And the townspeople noticed those weird effects; Tesla was electrifying the ground beneath their feet on the return bounce of the wave.

Eventually, he got it tuned, keeping things at low power. But in the spirit of a true hacker, just once he decided to run it wide open, just to see what would happen. Just what was the upper limit of the wave he would build up, bouncing back and forth in the planet below? He had his Coil hooked to the ground below it, the 200 foot antenna above it, and getting as much electricity as he wanted right off the city power supply mains. Tesla went outside to watch (wearing three inch rubber soles for insulation) and had his assistant, Kolman Czito, turn the Coil on. There was a buzz from rows of oil capacitors, and a roar from the spark gap as wrist-thick arcs jumped across it. Inside the lab the noise was deafening. But Tesla was outside, watching the antenna. Any surge that returned to the area would run up the antenna and jump off as lightning. Off the top of the antenna shot a six foot lightning bolt. The bolt kept going in a steady arc, though, unlike a single lightning flash. And here Tesla watched carefully, for he wanted to see if the power would build up, if his wave theory would work. Soon the lightning was twenty feet long, then fifty. The surges were growing more powerful. Eighty feet -- now thunder was following each lightning bolt. A hundred feet, a hundred twenty feet; the lightning shot upwards off the antenna.

Thunder was heard booming around Tesla now (it was heard 22 miles away, in the town of Cripple Creek). The meadow Tesla was standing in was lit up, with an electrical discharge very much like St. Elmo's Fire, casting a blue glow. His theory had worked! There didn't seem to be an upper limit to the surges; he was creating the most powerful electrical surges ever created by man. That moment he set the record, which he still holds, for manmade lightning. Then everything halted. The lightning discharges stopped, the thunder quit. He ran in, found the power company had turned off his power feed. He called them, shouted at them -- they were interrupting his experiment! The foreman replied that Tesla had just overloaded the generator and set it on fire, his lads were busy putting out the fire in the windings, and it would be a cold day in hell before Tesla got any more free power from the Colorado Springs power company!

All the lights in Colorado Springs had gone out. And that, readers, is to me the greatest hack in history. I've seen some amazing hacks. The 8-bit Atari OS. The Mac OS. The phone company computers -- well, lots of computers. But I've never seen anyone set the world's lightning

record and shut off the power to an entire town, "just to see what would happen". For a few moments, there in Colorado Springs, he achieved something never before done. He had used the entire planet as a conductor, and sent a pulse through it. In that one moment in the summer of 1899, he made electrical history. That's right, in 1899 -- darn near a hundred years ago. Well, you may say to yourself, that's a nice story, and I'm sure George Lucas could make a hell of a movie about it, special effects and all. But it's not relevant today. Or isn't it? Hang on to your hat.

THE SDI AND THE TESLA COIL

We just talked about an amazing hack that Nikola Tesla did - bouncing an electrical wave through the planet, in 1899, and setting the world's record for manmade lightning. Now, let me lay a little political groundwork. Last October was the Hackercon 2.0, another gathering of computer hackers from all over the world. It was an informal weekend at a camp in the hills west of Santa Clara. One of the more interesting memories of Hackers 2.0 were the numerous diatribes against the Strategic Defense Initiative. Most speakers claimed it was impossible, citing technical problems. So many people felt obligated to complain about SDI that the conference was jokingly called "SDIcon 2.0". Probably the high(?) point of the conference was Jerry Pournelle and Timothy Leary up on stage debating SDI. I'll leave the description to your imagination -- it was everything you can think of and more. Personally, it was disturbing to see how many gifted hackers adopting the attitude of "let's not even try". That's not how Microsoft got started. Mention to a Time magazine journalist was made that if anyone could make SDI go, it was the hackers gathered there. I also believe that the greatest hacker of them all, Nikola Tesla, solved the SDI technical problem back in 1899. The event was so long ago, and so amazing, that it's pretty much been forgotten; Let me present the case for the Tesla Coil and SDI.

SOVIET USE OF THE TESLA COIL

You will recall that Tesla was born in Yugoslavia (although back then, it was "Serbo-Croatia"). He is not unknown there; he is regarded as a national hero. Witness the Nikola Tesla museum in Belgrade, for instance. There's been interferences picked up, on this side of the planet, which is causing problems in the ham radio bands. Direction finding equipment has traced the interference in the SW band to two, sources in the Soviet Union, which are apparently two high powered Tesla Coils. Why on earth are the Soviets playing with Tesla Coils? There's one odd theory that they're subjecting Canada to low level electrical interference to cause attitude change. Sigh. Moving right along, there's another theory, more credible, that they are conducting research in "over the horizon" radar using Tesla's ideas. (The Soviets are certainly not saying what they're doing.) When I read about this testing, it worried me. I don't think they're playing with attitude control or radar. I think they're doing exactly what Tesla did in Colorado Springs. Just a guess? I think not.

COMPUTERS AND GROUNDING

Time for another discussion of grounding. Consider your computer equipment. You've doubtlessly been warned about static electricity, always been told to ground yourself (thus

discharging the static into the ground, an electrical sinkhole) before touching your computer. Companies make anti-static spray for your rugs. Static is in the 20,000 to 50,000 volt range. Computer chips run on five to twelve volts. The internal insulation is built for that much voltage.

When they get a shot of static in the multiple thousand volt range, the insulation is punctured, and the chip ruined. Countless computers have been damaged this way. Read any manual on inserting memory chips to a PC, and you'll see warnings about static; it's a big problem. Now Tesla was working in the millions of volts range. And his special idea -- that the ground itself could be the conductor -- now comes into relevance, nearly a hundred years after his dramatic demonstration in Colorado Springs. For, you see, in our wisdom we've grounded our many computers, to protect them from static. We've always assumed the ground is an electrical sinkhole. So, with our three-pin plugs we ground everything; the two flat pins in your wall go to electricity (hot and neutral); the third, round pin, goes straight to ground. That third pin is usually hooked with a thick wire to a cold water pipe, which grounds it effectively. Tesla proved that you can give that ground a terrific charge, millions of volts of high frequency electricity. (Tesla ran his large coil at 33 KHz). Remember, the lightning surging off his Coil was coming from the wave bouncing back and forth in the planet below. In short, he was modifying the ground's electrical potential, changing it from an electrical sinkhole to an electrical source. Tesla did his experiment in 1899. There weren't any home computers with delicate chips hooked up to grounds then. If there had been, he'd have fried everything in Colorado Springs. There was, however, one piece of electrical equipment grounded at the time of the experiment, the city power generator. It caught fire and ended Tesla's experiment. The cause of its failure is interesting as well. It died from "high frequency kickback", something most electrical engineers know about. Tesla forgot that as the generator fed him power, he was feeding it high frequency from his Coil. High frequency quickly heats insulation; a microwave oven works on the same principle. In a few minutes, the insulation inside that generator grew so hot that the generator caught fire. When the lights went out all over Colorado Springs, there was the first proof that Tesla's idea has strategic possibilities. It gets scarier. Imagine Tesla's Coil, busily pumping an electrical wave in the Earth.

On his side of the planet, he was getting 130 foot sparks, which is a hell of a lot of voltage and current. And simple wave theory will show you that those sort of potentials exist on the far side of the planet as well. Remember, the wave was bouncing back and forth, being reinforced on every trip. The big question is how focused the opposite electrical pole will be. No one knows. But it seems probable that the far side of the planet's ground target area could be subjected to considerable electrical interference. And if computer equipment is plugged into that ground, faithfully assuming the ground will never be a source of electricity, it's just too bad for that equipment. This sort of electrical interference makes static look tiny by comparison. It doesn't take much difference in ground potential to kill a computer connected across it. Lightning strikes cause a temporary flare in ground voltage. Imagine the effect on relatively delicate electronics if someone fires up a Tesla Coil on the far side of the planet, and subjects the grounds to steep electrical swings. The military applications are pretty obvious -- those ICBM's in North Dakota, for instance. It's possible they could be damaged in their silos, and from thousands of miles away. Running two or more Coils, you don't have to be exactly on the far side of the planet, either. Interference effects can give you high points where you need with

varied tunings. Maybe, just maybe, the Soviets aren't doing "over the horizon" radar. Maybe they just bothered to read Tesla's notes. And maybe they are tuning up a real big surprise with their twin Coils.

"STAR WARS" AND THE TESLA COIL

You've heard of the Strategic Defense Initiative, or "Star Wars". We're searching for a way to stop a nuclear attack. Right now, we've got all sorts of high powered research projects, with the emphasis on "new technology". Exciter laser, kinetic kill techniques, and even more exotic ideas. As any of you know that have written computer programs, it's darned hard to get something "new" to work. Maybe it's an error to focus on "new" exclusively. Wouldn't it be something if the solution to SDI lies a hundred years ago, in the forgotten brilliance of Nikola Tesla? For right now we can immobilize the electronics of installations half a planet away. The technology to do it was achieved in 1899, and promptly forgotten. Remember, we're not talking vague, unproven theories here. We're talking the world's record for lightning, and the inventor whose power system lights up your house at night.

THE TESLA COIL WORKS.

All we'd have to do is build it. You might not believe the story about Tesla in Colorado Springs, and what he did. It's pretty amazing. It has a way of being forgotten because of that. And I'm not sure you want to hear about the SDI connection. Still, as you work on a computer, remember Tesla. His Tesla Coil supplies the high voltage for the picture tube you use. The electricity for your computer comes from a Tesla design AC generator, is sent through a Tesla transformer, and gets to your house through 3-phase Tesla power. Tesla's inventions... they have a way of working..

[[INDEX](#)]



The Frank.Germano.com on-line Bookstore

Index

- [Section One - Nikola Tesla Books](#)
- [Section Two - Viktor Schauberger Books](#)
- [Section Three - Water research Books](#)
- [Section Four - "Earthship" & "Architerra" sustainable homes books](#)
- [Section Five - alternative and passive solar homes books](#)
- [Section Six - Charles Woods; architectural passive solar design books](#)
- [Section Seven - Great study Bibles & Christian Study Tools](#)

even more from Amazon.com

Here is the most comprehensive collection of books on Nikola Tesla, and Viktor Schauberger on the web. All of these books are (now) available from "AMAZON.COM"... just click on any highlighted link, or the picture and go right to the page, for ordering or a more detailed description. I have also included my selection of favorite "earth friendly" and environmentally sound construction techniques for your new or existing home. You'll see "Earthship" style environmentally friendly, sustainable homes... Architerra (my personal favorite - a high thermal mass, passive solar home - "HTM")...underground, active solar, passive solar, earth banked, straw bale, rammed earth, etc., types of home building technique books, as well as books explaining techniques to live more energy efficiently, or completely "off-grid". So, if you're into helping "Mother Earth", and feel like having quite a few 'good reads'...scroll through each page. Enjoy.

Thanks for visiting the on-line bookstore...more items will be added weekly, so check back soon. FDG.

[[Christian Links](#)]



Applications of a Schauberger Vortex, with the Tesla Turbine

(some fresh air for a dying planet)

Dynamic Hydropower

The suction turbine or jet turbine of Viktor Schauberger



The screenshot shows an Amazon.com banner with a search dropdown menu. The dropdown menu lists categories: Computers, Books, Music, and DVDs. Below the banner, there are several product listings for books and DVDs. Each listing includes a small image of the cover, the title, the author, and the price. The products are:

- Hidden Nature** by Alick Bartholomew: New \$35.00!, Used \$23.00!
- The Fertile Earth** by Viktor Schauberger...: New \$13.57!
- Det levande vattnet** by Olof Alexandersson...
- Living Water** by Olof Alexandersson...: New \$11.95!
- The Schauberger Companion** by Callum Coats: New \$21.95!
- Land der Trumer** by Rene Freund: Used \$9.00!
- Living Energies** by Callum Coats: New \$17.79!
- Living Energies** by Callum Coats: New \$19.95!
- Living water** by Olof Alexandersson...

At the bottom of the page, there is a note "(Prices May Change)" and a link for "Privacy Information".

Hydropower engineering, up to this day, is almost exclusively concerned with two variables, one being the altitude differential between head water and turbine and the other the quantity of water that can be brought to flow through the turbines. ***This page was originally created by, and is used with exclusive permission from Josef Hasslberger.*** It has been edited for content. You may visit the original webpage at <http://www.hasslberger.com>, where you will find even more documentation on the vortex theories proposed by Viktor Schauberger. It is a very well laid out site.

A third important variable, the velocity of flow of water, is generally not thought to be important. It is taken into consideration only as the velocity resulting from the release of water pressure connected to

and dependent on altitude differential but not as an important factor in its own right. In fact, current design of hydropower facilities normally excludes utilization of the dynamic energy potential inherent in the free flow of water. A dam destroys this natural energy potential by bringing the water from its dynamic state of flow to a static state, a complete absence of motion.

If we study the writings of Viktor Schauberger and Ludwig Herbrand, we find that the energy inherent in the free and unhindered flow of water may be potentially much greater than that obtainable from the exclusive use of pressure resulting from altitude differential. A normal flow of water rather than an altitude-induced pressure, has been used in mills and old blacksmith hammer works of the pre-industrial era.

Viktor Schauberger

In recent times, it was Viktor Schauberger, the Austrian inventor and genial observer of nature's ways who first advocated the use of increased water velocity rather than water pressure for the production of hydroelectric power. He obtained a patent for what he termed a jet turbine (Strahl turbine) as early as the year 1930.

The principles used by Schauberger in order to increase water velocity were the jet configuration of the water inlet pipe and the promotion, by spiral ribbings on the inside of the jet, of a vortex motion of the water.

Schauberger's patent actually gives us two very important clues to innovative changes in hydropower technology. The first one is, that a pipe configured as a funnel or jet will increase the velocity of the water's flow by restricting the space available in which the water may flow. This increase in velocity is especially great if the funnel or jet allows the water to form a characteristic flow pattern known as a vortex. This vortex pattern itself has a tendency, quite separate from the jet-effect, to increase the velocity of the water, to decrease its temperature and to augment the water's density.

The second innovation proposed by Schauberger is a revolutionary design of the turbine, obtaining rotation at very high speeds and at the same time avoiding the usual difficulties of cavitations found in normal high speed turbine designs. In fact Schauberger's turbine wheel is of conical shape, with blades spiraling down the surface of the cone in a corkscrew pattern, and it is located in the center of the jet of water. The corkscrew turbine wheel parts the flow of water, takes up the water's dynamic energy and lets the flow continue without major disruption. Turbines of current design, hacks the water into thousands of destructive counter flows and cross vortices, thus wasting much of the available energy and causing the common problem of cavitations, a super fast corrosion and destruction of turbine blade material.

Here is the description of this new type of turbine as given in Schauberger's patent number 117 749: The subject of the invention is a hydropower machine, which utilizes the living energy of a jet of water for the purpose of power generation.

According to the invention, the turbine wheel is a cone with corkscrew-like blades. The cone is aligned with its axis in the direction of the axis of the jet. In this way the jet of water is split and diverted out of

its course and thus gives its whole living energy to the spinning cone in a way that, providing the length of the cone and the width of its base are in a correct relation to each other and provided the blades are set at the correct angle, these parameters depending on the speed of the water jet, the water will flow out of the machine without agitation.

The illustration is an approximate schematic representation of the invention.

The spinning cone, which is aligned with its axis (1) in the direction of the water jet leaving the jet pipe (2), is made up of blades (3) in the form of a corkscrew.

The ends (4) of these blades (3) are bent somewhat upwards against the direction of the arriving water jet in order to cause a diversion of the jet and to transfer as much as possible of the living energy of the jet to the spinning cone.

On the inside of the jet pipe (2) there are screw-like ribs (5) promoting a spin, which according to actual observations increase the speed of the water jet and the efficiency of the machine.

PATENT CLAIMS:

A jet turbine, distinguished by the fact that in the path of the water jet and aligned with its axis so as to split the jet, there is a turbine wheel in the form of a cone, the surface of which is formed of corkscrew-like blades.

A jet turbine according to claim 1, distinguished by a jet pipe (2) with ribs (5) slanted in the direction of spin of the turbine wheel's.

This patent was applied for in 1926 and granted in 1930. It seems that Schauberger actually used a small turbine of this design in a stream of water near the forest wardens' building during those years, but no reliable records are available.

Herbrand

Another instance of the use of the dynamic powers of flowing water has been documented by Ludwig Herbrand, a German engineer who as a student in the mid 1930's was called to evaluate and calculate the parameters of some generators and exciter units that had recently been installed in the Rheinfeld power station, as well as to design electrical overload protection and relevant switching mechanisms for these generators. He was also required to compare the generators with those of another power station that had been described in an article of a specialized magazine.

Much to the dismay of the then young and inquisitive engineering student, it seemed that the generators under examination were supplying more electrical energy than they should have, according to accepted theory. One of the generators of the Rheinfeld power plant, with 50 cubic meters of water per second and an altitude differential of only one meter supplied just as much power as a



generator in near Ryburg-Schwsrstadt, which had a capacity of 250 cubic meters of water per second and an altitude differential from head waters to turbine of 12 meters!

That fact was confirmed by prof. Finzi, the designer of the turbines and generators, saying to young Herbrand:

"Do not worry about this. It is correct. The generator has been working without problems for some time now. Make the calculations backwards and you will see for yourself. We are electrical engineers. Why, those other problems are not ours to solve, we leave them to the water people. We have repeated our measurements and the generator's yield of power is exactly as specified. The only thing is - no one knows about this."

Herbrand was soon drafted into the army and World War II did not allow him to pursue the matter further. Only much later, in the 1970s and 1980s, Herbrand came back to the calculations made for his engineering exams and tried - so far without success - to interest industry and government in this different and more efficient use of hydropower.

Technical facts

I shall attempt to delineate here the technical facts, using calculations that are based on accepted formulas and physical considerations confirmed by actual experiment, to show that with a different approach to hydropower engineering, we could obtain significantly more electrical power than is being extracted from hydro resources today, with simpler machinery and less expenditure, as well as less disturbance to the environment.

As mentioned above, current hydropower engineering works with water pressure, obtained as a result of the altitude differential between head waters and location of the turbine. This pressure, when released through the turbine, results in a momentary acceleration of the water and thus in a certain velocity of the water jet. This velocity is calculated with the formula

$$v = \sqrt{2 g h}$$

v being the velocity, g the gravitational acceleration of the earth (9.81 m/sec²) and h the altitude differential measured in meters.

Example: An altitude of 12 m results in a velocity of $\sqrt{2 \cdot 9.81 \cdot 12} = 15.3$ m/sec.

The progression of velocity in relation to altitude differential is shown in the following table.

altitude diff.	12 m	24 m	36 m	48 m	60 m
velocity	15.3 m/sec	21.7 m/sec	26.6 m/sec	30.7 m/sec	34.3 m/sec

altitude diff.	72 m	84 m	96 m	108 m	120 m
velocity	37.6 m/sec	40.6 m/sec	43.4 m/sec	46 m/sec	48.5 m/sec
altitude diff.	132 m	144 m	156 m	168 m	180 m
velocity	50.9 m/sec	53.15 m/sec	55.3 m/sec	57.4 m/sec	59.4 m/sec
altitude diff.	192 m	204 m	216 m	228 m	240 m
velocity	61.4 m/sec	63.3 m/sec	65.1 m/sec	66.9 m/sec	68.6 m/sec

These values are rendered graphically below.

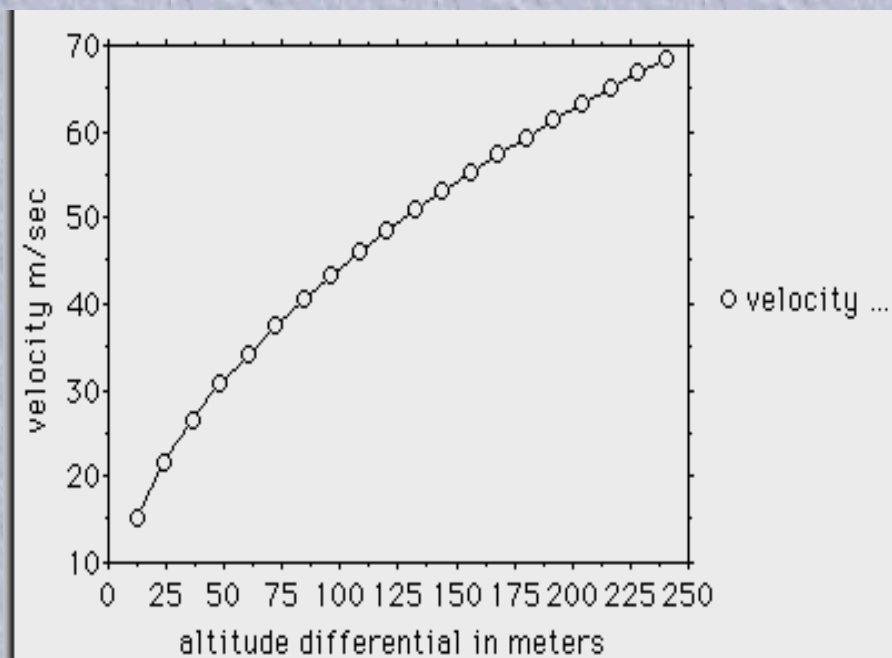

We see that the curve of velocity at first increases more steeply and then tends to flatten with higher altitude differentials.

Let us now examine the energy output in kilowatt with increasing altitude differential.

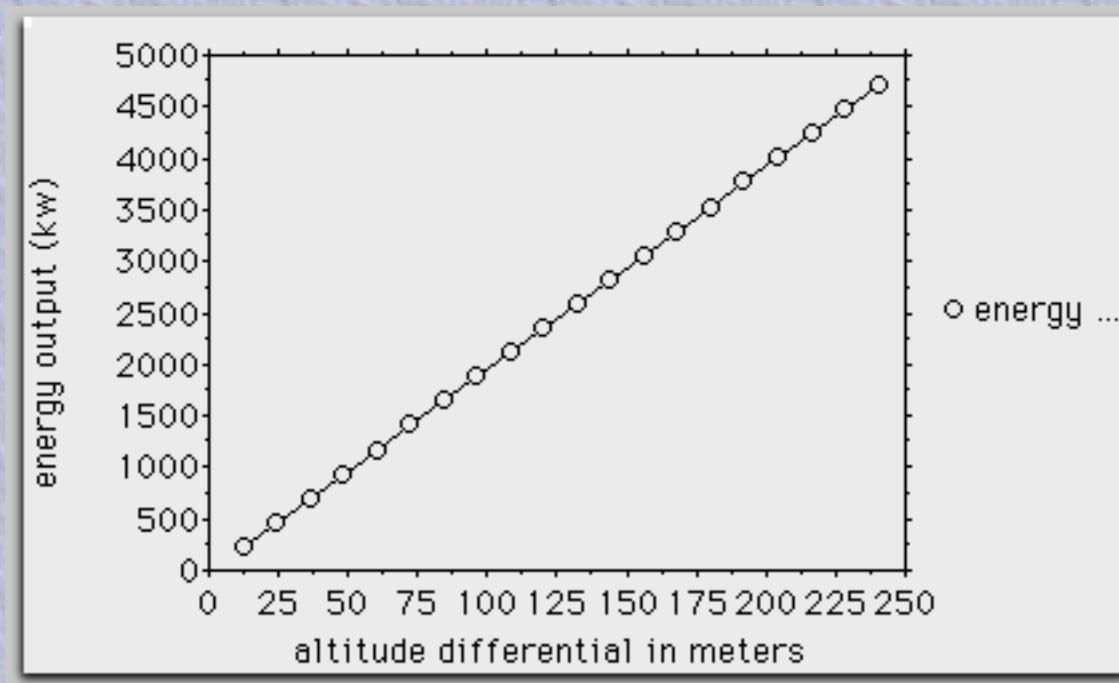

The increase of energy output is linear, as shown in the graphic above.

Calculation

The electric energy that can be obtained from water is calculated on the basis of the velocity of flow and the mass of the water, i.e. magnitude of flow measured in cubic meters per second, according to the formula

$$E_{kin} = \rho \cdot v^2 \cdot Q \quad (\text{kw})$$

An example, assuming a velocity of 25 m/sec and a mass of 5 cubic meters per second:

$$5 \cdot 2 = 2.5 \cdot 25 \cdot 25 = 1562.5 \text{ kw}$$

For the purpose of comparison, here are some further examples (assuming a small constant flow of water, only 2 cubic meters per second):

velocity	15 m/sec	20 m/sec	25 m/sec	30 m/sec	35 m/sec
energy	225 kw	400 kw	625 kw	900 kw	1225 kw

velocity	40 m/sec	45 m/sec	50 m/sec	55 m/sec	60 m/sec
energy	1600 kw	2025 kw	2500 kw	3025 kw	3600 kw

velocity	65 m/sec	70 m/sec	75 m/sec	80 m/sec	85 m/sec
energy	4225 kw	4900 kw	5625 kw	6400 kw	7225 kw

velocity	90 m/sec	95 m/sec	100 m/sec	105 m/sec	110 m/sec
energy	8100 kw	9025 kw	10000 kw	11025 kw	12100 kw

These figures show, that a doubling of velocity quadruples the power output, a threefold increase of velocity leads to a nine fold increase of power output. In other words, we have an exponential increase. The curve of energy increase plotted against water velocity is shown in this third graphic.

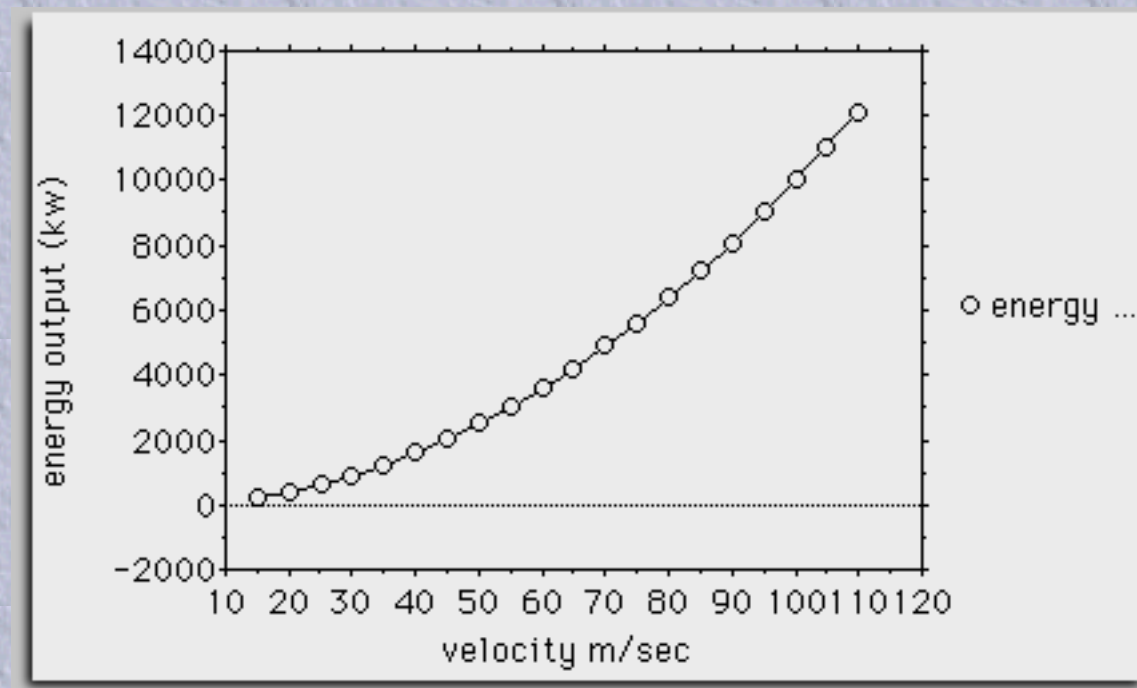

The graphic representation makes it clear, that a velocity increase brings progressively larger increases of energy. Therefore, the higher the velocity of the water, the greater the overall efficiency of the power plant!

For the purpose of utilizing hydropower for generating electrical energy, it is however quite irrelevant whether the velocity of the water is the result of pressure obtained through altitude differential or whether it is obtained in some other way, such as encouraging the natural tendency of water to flow. And it seems that we can increase the velocity of flow of water almost at will.

How to increase electrical output

There are two basic variables in hydropower engineering that determine electrical output. They are the amount of water available and the velocity of flow. The first variable, the amount of water available, depends very much on location and is generally not subject to increase by human intervention.

It is the second variable, the velocity of the water's flow, which can be manipulated in many ways. Apart from increasing water pressure, which is a comparatively inefficient way to increase flow velocity, this parameter can be influenced by other, more simple and more cost effective engineering solutions.

It is a common principle in rocketry to increase the velocity of flow of the hot exhaust gases by a restriction of the path of flow of these gases. This is called the jet principle and has been used successfully for decades.

The same principle can be used to increase the velocity of a flow of water, such as a river. In fact, where a river is forced, by the natural configuration of terrain, to flow through a narrow gorge, the velocity at the narrowest point is much higher than it is before and after the river's passage through the gorge. This effect can be utilized by finding a natural gorge or by artificially narrowing a river's bed so as to bring about an increase in water velocity.

Another way to increase velocity of flow in water is to promote the formation of a longitudinal vortex. This is a rolling or spinning motion, the axis of which coincides with the direction of flow of the water. Such vortices have the property of causing an increase of the velocity of flow, and a contraction of the diameter of the space needed by the body of water. They also cause a lowering of the water's temperature and thus an increase in its density. (The highest specific density of water is reached at a temperature of + 4 C.)

Water has a natural tendency to form vortices, especially if its flow is accelerated by some external influence such as gravity. We can observe this by noting the swirl with which a full bathtub or sink or any other container full of water empties, if the water is forced to flow through a pipe connected to a hole in the bottom of the container. But even a simple water faucet, releasing a flow of water, will show this same phenomenon if the water flows relatively undisturbed, without bubbles or agitation. As the water picks up speed, it forms a distinctly funnel-shaped vortex right before our eyes.

A confirmation of this tendency of vortices to increase water velocity (or in other words to decrease resistance to the water's flow) comes from experiments performed in 1952 at the Technical College in Stuttgart by Prof. Franz Pspel and Viktor Schauberger.

The experiments were performed with pipes of different materials and different shapes, to determine if either materials or shapes had an influence on the resistance of the flow of water in pipes.

It seems that best results were achieved with copper pipes, and that this material caused less resistance to the water's flow than even the smooth glass pipes used as comparison. But the most important datum emerging from these experiments is, that by using a certain spiral configured pipe, based on the form of the kudu antelope's horn, the friction in this pipe decreased with an increase in velocity and at a certain point, the water flowed with a negative resistance.

Theory and practice

The best theory is not worth the paper it is written on, if it cannot be put into practice. We shall therefore examine the practical utilization of these principles in hydropower engineering.

The object is to increase the velocity of the flow of water to such a degree that the resulting jet will release more kinetic energy than conventional utilization of water pressure achieved with comparable means.

Step 1:

As a first step, a river's normal flow is brought to higher velocity by the expedient of a wall that gradually restricts the river's bed. This will increase the normal velocity of flow of 2 - 5 m/sec to a sizeable 10 - 15 m/sec.

Step 2:

At this point, in order to further increase velocity, we must provide a channel of flow that more closely resembles the shape of a natural vortex. We do this by channeling the already swiftly flowing water at the narrowest point of the river bed into an approximately round funnel or jet-pipe, which gradually further restricts the diameter of the water's channel of flow and thereby causes a further increase in velocity.

In order to aid this process, we can promote the formation of a vortex in the funnel or jet-pipe which will ensure that the water exits the jet at a considerable velocity. This is done either by spiral ribs on the inside of the jet-pipe as proposed by Schauberger, or by forming the whole pipe in a slightly corkscrew configuration.

Installing a turbine and generator at the release point of the water jet, of the design proposed by Schauberger, although, [HERE](#) is where I would like to substitute a [TESLA Bladeless Boundary Disk Turbine](#) (a "multi-stage" unit), will now provide an output of electrical power much higher than that achieved by comparable means in the conventional way.

Where step 1 is not practicable because of the river being too small, or where we simply want to adapt existing power plants to utilize the dynamic energy of water flow, step 2 can still be profitably combined with current small hydropower plant design, by altering the shape of the penstock to a funnel or jet-pipe configuration, thus obtaining part of the velocity increase from normal use of gravity and another part through the specific action of the jet effect and the vortex flow.

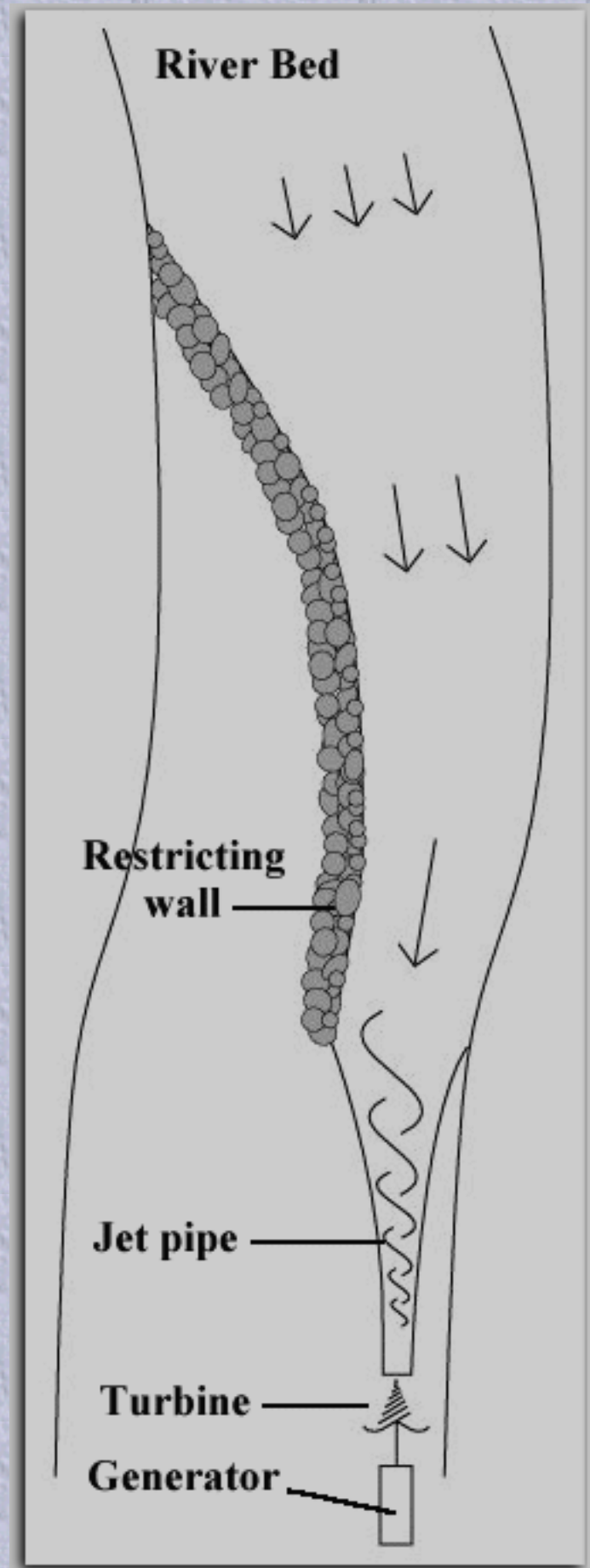

No theoretical limitation

Are there limits to how fast a water-jet can be made to flow? This is a question we should obviously ask ourselves before embarking on this kind of project.

It seems that theoretically there are no limitations, as long as the vortex mode of flow is used. If water is forced to flow in straight pipes, resistance increases with the increase of velocity. Not so when we allow the water to flow at its natural mode, accommodating the resulting vortex in our pipe design. In this case, resistance can be very low and even negative, as shown by the experiments performed in Stuttgart.

For purposes of estimating the potential benefits of using the dynamic powers inherent in the flow of water, we can conservatively assume that we should be able to obtain, without particular difficulties, velocities between 40 and 50 m/sec. This is an estimation based on the observation of Herbrand that at the Rheinfelden power plant a velocity of 35 m/sec was achieved.

We can see from the above statistical tables that 45 m/sec of velocity are equivalent to an altitude differential of more than 100 meters. And assuming that we have a flow of water of 10 cfm/sec, we can predict (at $v = 45$ m/sec) an energy output of 10 megawatt. This is a considerable amount of power and it can be obtained almost anywhere along the normal course of a river, without the costly and environmentally questionable practice of constructing a dam and a man made lake to obtain 100 meters of altitude differential.

If it is true that the water's velocity of flow can be increased almost at will and with comparatively simple means at a fraction of the cost of current hydropower designs, someone might ask: Why are we not using this obviously superior method?

Let's look to [Nikola Tesla's](#) fantastic speech, as recorded to the Manufacturers Record; September 9th, 1915. "The Wonder World To Be Created By Electricity." for some insight.

THE POWER OF THE FUTURE

"We have at our disposal three main sources of life-sustaining energy- fuel, water-power and the heat of the sun's rays. Engineers often speak of harnessing the tides, but the discouraging truth is that the tidewater over one acre of ground will, on the average, develop only one horse-power. Thousands of mechanics and inventors have spent their best efforts in trying to perfect wave motors, not realizing that the power so obtained could never compete with that derived from other sources. The force of wind offers much better chances and is valuable in special instances, but is by far inadequate. Moreover, the tides, waves and winds furnish only periodic and often uncertain power and necessitate the employment of large and expensive storage plants. Of course, there are other possibilities, but they are remote, and we must depend on the first of three resources."

"If we use fuel to get our power, we are living on our capital and exhausting it rapidly. This method is barbarous and wantonly wasteful, and will have to be stopped in the interest of coming generations. The heat of the sun's rays represents an immense amount of energy vastly in excess of water-power. The earth receives an equivalent of 83 foot-pounds per second for each square foot on which the rays fall perpendicularly. From simple geometrical rules applying to a spherical body it follows that the mean rate per square foot of the earth's surface is one-quarter of that, or 20 3/4 foot-pounds. This is to say over one million horse-power per square mile, or 250 times the water-power for the same area. But that is only true in theory; the practical facts put this in a different aspect."

"For instance, considering the United States, and taking into account the mean latitude, the daily variation, the diurnal changes, the seasonal variations and casual changes, this power of the sun's rays reduces to about one-tenth, or 100,00 horse-power per square mile, of which we might be able to recover in high-speed low-pressure turbines 10,000 horse-power. To do this would mean the installment of apparatus and storage plants so large and expensive that such a project is beyond the pale of the practical. The inevitable conclusion is that water-power is by far our most valuable resource. On this humanity must build its hopes for the future. With its full development and a perfect system of wireless transmission of the energy to any distance man will be able to solve all the problems of material existence. Distance, which is the chief impediment to human progress, will be completely annihilated in thought, word and action. Humanity will be united, wars will be made impossible and peace will reign supreme." **Nikola Tesla, September 9, 1915**

Fixed ideas and the law of conservation of energy

It is very hard to un-learn something one studied and especially if what was learned was then needed to pass an examination. The weight of so called natural laws brought to bear to support these doctrines makes it even more difficult for any one person to stand up and say hey, we have overlooked something here!

Of course everybody knows that water has to be pressurized if we are to use it for hydroelectric power generation. And everybody knows as well, that the technology of hydropower engineering has been well in hand since the turn of the century. So why bother to look any further?

Not so Ludwig Herbrand. He has fought an unceasing battle for more than 20 years now, to obtain recognition for this new technology. Literally hundreds of letters to government and industry, as well as international institutions with just so many negative replies, more or less politely telling him that his proposals are not welcome.

It is difficult to break through this barrier of knowledge, especially when the experts think they see a violation of the law of conservation of energy. Conservation of energy is invoked when calculations do not seem to permit a higher energy output. But in this case we have a factor that has been neglected in our calculations, not a violation of conservation laws.

Water is an accumulator of energy

There is some evidence that the decrease of water temperature that is a consequence of vortex motion

provides the energy to the water that we then see as kinetic energy in the form of increased water velocity. In this way a vortex would transform heat (which is random molecular motion) into dynamic energy (which is motion in a certain direction). Schauberger stressed the fact that water could store enormous amounts of energy by being heated up. He states in an article about the Danube river that in order to warm up 1 cubic meter of water by only 0.1 degree C, one needs about 42,700 kgm of energy, saying that this goes to show the enormous energies that are bound when water is heated up and are released when water cools down.

Thermodynamics, as taught in our schools and universities does not allow for such a two-way transformation of heat at low temperature differentials. Thermodynamics is based on observation of steam machines and has little to do with nature, although some insist that the so-called laws of thermodynamics are natural laws. Nevertheless, thermodynamics is not able to explain certain natural phenomena.

In calculations of electrical power yield, velocity is not considered separately but as a result only and exclusively of altitude differential. That is like saying, there is no other way of achieving water velocity than pressure. It may be the way the experts calculate, but physical reality is different. Water velocity, as we have seen, is not exclusively linked to pressure but may be achieved with different means.

Thus the correct way to calculate is to start from velocity and arrive at the power output. Altitude differential and the velocity equivalent as calculated in the formula given above are a special case, not the general rule.

We must distinguish between the pressure-induced velocity equivalent and the natural velocity of flowing water. That is to say we must distinguish between gravity and inertia. These two forces are similar in their effects but they are nevertheless two distinctly different forces. This article does not allow a detailed examination of the physical forces involved.

I hope that this article may contribute to overcoming the knowledge barrier, the various everybody know in the field of hydro engineering. To anyone wishing to utilize the dynamic powers of water I recommend a study of the writings of Viktor Schauberger, the great master of hydro engineering who remained an outsider to official science all of his life, because his views were so radically different from those of the professors of his time.

With the union of the Tesla Bladeless Boundary Turbine/Pump, with the theories of Victor Schauberger...a true step towards "non-polluting, free energy", derived from our nation's rivers, would result. I offer another concept of vortex and water power, in the form of an invention from a Mr. David Dennard (May God Bless his soul) - [WHIRLPOWER](#) the power from tapping a whirlpool and its precession.

So What's The Problem?!

Well, the problem is not the technology...it's the **implementation** of the technology. I'll be very brief with an explanation. In the United States, you need to get an **F.E.R.C. License** to install a hydro electric plant. In order to get a License you need to coordinate the installation with **DEO, Fish &**

Wildlife, Stream Encroachment, SPEDES, The US Army Corp of Engineers (if navigable), Dam Safety, National & State Historical Society and every other "Tom, Dick & Harry" out there.

Furthermore, in order to obtain the license, you need to **compete**, which means you need to develop the project at a 75-80% of maximum flow. This is done to insure the site is beneficial. The long & short of this is, although you spend all this money to maximize the hydraulic turbines, they only run 20 % of the year at the maximum design capacity. Combine this with hydraulic flows' peak in the spring and fall (not peak times during summer & winter) when there is a glut of power on the market and you are lucky to get **2 cents per kWh**. That's the short and simple of it. Until the American people get "fed up" enough to **initiate** changes in the political make-up of the system...we get it right up the "you know what" in regards to being able to have virtually non-polluting, environmentally sound electrical energy production. Think about this - we could easily implement all of the technology presented on this webpage quite easily. From a company standpoint, i.e.: profitability and sustainability, we simply could not afford to do so...that is, as long as these license restrictions are kept in place. All of this is up to the American people to decide. Eventually, I'm sure we will be forced into finding environmentally sensible and sustainable power generation...until then...we wait.

So, to "re-quote" Nikola Tesla from one of the above paragraphs - "***The inevitable conclusion is that water-power is, by far, our most valuable resource. On this, humanity must build its hopes for the future. With its full development and a perfect system of wireless transmission of the energy to any distance, man will be able to solve all the problems of material existence. Distance, which is the chief impediment to human progress, will be completely annihilated in thought, word and action. Humanity will be united, wars will be made impossible, and peace will reign supreme.***" Nikola Tesla, September 9, 1915

If only that were true. Thank you for your time

Frank Germano, President, International Turbine And Power, LLC.

[For a complete, technical description of this technology -](#)
[WATER POWER - click here.](#)

[Frank Germano](#)

**Co-Founder and President
International Turbine And Power, LLC
931 Rumsey Avenue, PO Box 550
Cody, Wyoming**

Suggested book: ["Living Energies "](#) by Callum Coats. Viktor Schauberger's Brilliant Work with Natural Energies, explained (ISBN: 0-946551-97-9)

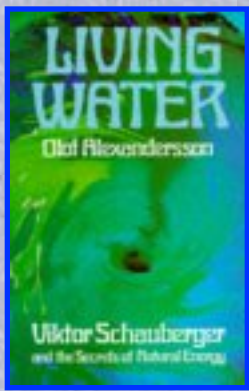

The original translation of Viktor Schauberger's work, "[Living Water](#)", by Olof Alexandersson...start here, and get each one in order. This is an excellent, brief introduction to the thought of Viktor Schauberger, and I hope it inspires works which are more complete. Callum Coates' books reach in this direction, but what is really needed are more people to read these books, synthesize their information, and come up with new and original books which take us further into depth in these areas. This will probably involve synthesizing the work of Schauberger, Grander, Bienveniste, and others. An understanding of Schauberger is very important for those attempting to reconstruct an Indigenous European Perspective. Schauberger has the elements of a modern water shaman, and his shamanic / intuitive techniques of letting his body float with the water should be closely correlated with what Hans Peter Duerr has to say about "out of body" experience in his tome "Dreamtime". Although Schauberger lived in the 20th Century, his perspective allows us to imagine back what earlier indigenous practitioners may have been like. The Colonial, Imperialist Europe is only one side of the coin of Europe. We must also include the suppressed indigenous, pagan, and green sides. Significantly, the Inquisition represents a watershed in European history where a great deal of the indigenous healers and theorists were wiped out in holocaust proportions. An understanding of Schauberger, coupled with an appreciation of Steiner, Hildegard of Bingen, Hans Peter Duerr, and others, will allow us to reconstruct what a noncolonial, nonimperialist Europe was like. Understanding water's nature is essential in this regard, for water forms the basis of our understandings of flow. Furthermore, understanding water's energetic qualities will help us understand how it interacts with the body. Traditional Chinese Medicine, for example, would benefit from an accurate and holistic understanding of water's qualities. In short, this book is an excellent appetizer.

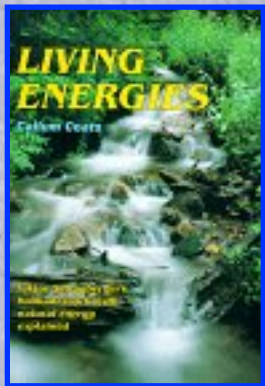

The book that started it all...[Living Energies](#), Callum Coats first Viktor Schauberger book. If you only buy one book, this would be the one to get. Fantastic. Living Energies, May 23, 2001

Reviewer: Frank D Germano, from Tafton, PA United States: This book started it all! Callum Coats basically brought to "light" the resurgence of interest in Viktor Schauberger's theories. This is truly a brilliant work. Water as a carrier of vital energy information, trees as bio-condensers of energy between the deep earth and the sun, how self-cleansing rivers nourish the landscape, how the future of the earth depends on the replanting of natural forests, revolutionary agricultural implements, free energy heater-coolers, jet engines and gravity defying machines invented by Schauberger in the 30's and 40's, home power generators...it's pretty much all here. It was a hard book for me to put down once I started reading, and I go back to it continually for reference. This book pretty much sums up Schauberger's work, which Coats then compartmentalized and expanded in the "Eco-Technology" series with four other books. I would highly advise getting this book, first, and reading it thoroughly, before moving on to the series, as it is a fascinating preface into discovering who Viktor Schauberger WAS, and learning just how far-reaching his theories were, and applicable to us, today. FDG.



1.) The first book of the "Eco-Technology series" - [The Water Wizard](#) - This book gives a lot of history on Schauberger. The nature of water, May 23, 2001

Reviewer: Frank D Germano, from Tafton, PA United States: This is the first book of the "Eco-Technology" series, and as so, gives you the foundation of the theories presented by Viktor Schauberger, and amplified by Callum Coats. It DOES contain quite a lot of previous information written in Living Energies (Coat's first Schauberger book), however, the discussion and the text is much more thoroughly covered. The substance of water, water supply, deep-sea water, the consequences of drinking purely mechanically treated water, notes on the secrets of water, high-frequency water, the pulsation and healing power of water, river regulation, groundwater tables, temperature and movement of water... notice my use of the word WATER. Yes, this book is about water, but, by reading it, just wait until you discover what you DID NOT know about "water". It is a very good start, and as I said, a foundation for understanding the theories of Viktor Schauberger. FDG.

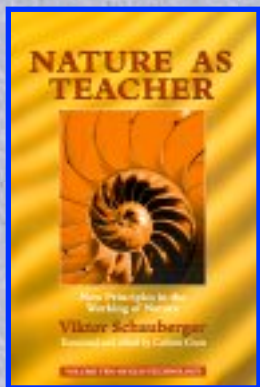

2.) Part two of the "Eco-Technology series" [Nature As Teacher](#), A great book on living with nature. A very nice read.

Our Senseless Toil, May 23, 2001: Reviewer: Frank D Germano, from Tafton, PA United States: I had to use a title from one of the books' opening chapters. This book is going to annoy some people. Callum Coats presents Viktor Schauberger's theories in a modern light. The laws of Nature, Questions for Science, Nature as Teacher, the fish-eagle, the swing, the trout, the ox, dancing logs and stones, the Genesis of water, the coming bio-technical age, the secret of the egg form...these are

elucidated...then comes the fun stuff... the age-old secret of the atom, implosive breathing, life-force and animated breathing, is there perpetual motion (?), organic syntheses, the false world view, the mechanical equivalent of heat, plasmolytic motion; this volume gives tremendous insight into what is happening in the world, today, and practical solutions on HOW we may yet save our world. Most telling is Schauberger's inane gut feelings on the powers at work in the environment, and living water. Hey, it's only volume two of the series. Get all four, and see how these books will influence YOU to change the way we look at the earth . FDG

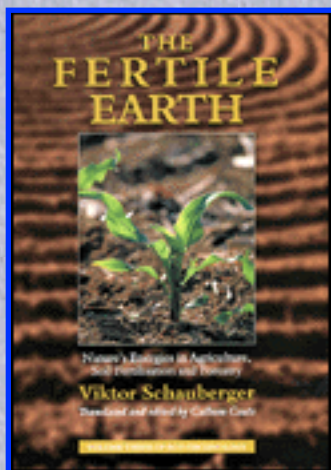

3.) [The Fertile Earth](#) , part three of the "Eco-Technology series. Pure drinking water, how to make it, the benefits produced in the body...the natural flow and paths of rivers, and how man has disturbed nature...organic, natural farming...trees as the life giving force on the earth...it's all hear! Are you trying to save Mother Earth?, May 23, 2001

Reviewer: Frank D Germano, from Tafton, PA United States: If you are in any way interested in the environment, then this book will appeal to you. This is the third book in the highly acclaimed "Eco-Technology" series by Callum Coats. Not only does the book delve into what man is doing to harm the environment, it also offers "fresh" ideas on what we can and should DO about it. I can't believe

"Green Peace" or some other pro-environmental group doesn't have this book as part of their by-laws! Fascinating. Of course, the entire book is based on the revolutionary work of Viktor Schauberger. This

one, if you are into farming, just have a back-yard garden, or are a hard core pro-earth person, will keep you reading till the end...and want to read the entire series. A very well written and inspiring book. A different view of natural phenomena, the influence of temperature and water movement, forestry, agriculture, the energy industry, the dying forest, timber and water in the building industry, soil fertilization, increased productivity...wow! Again, whether you are just into learning what's happening to the earth, and why, or you are serious about trying to DO something to stop the damage already done, this book will open your eyes. FDG

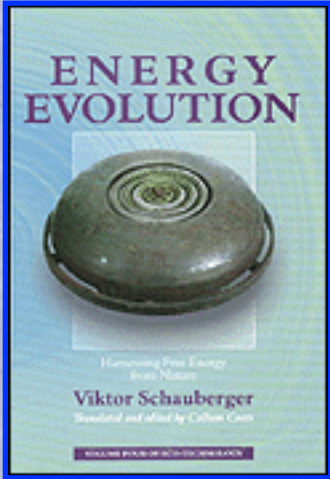

4.) [The Energy Evolution](#) , the final book of the "Eco-Technology series" (If you are interested in the designs and patents on Schauberger's devices, this is the book. Culmination of the Eco-Technology Series, May 23, 2001

Reviewer: Frank D Germano, from Tafton, PA United States: This book, being the fourth and last of the Eco-Technology series, is an incredible finish. Naturally, all of the book deals with Viktor Schauberger, and his theories on living water, and the environment. This book, however, goes deeper into the actual inventions than the previous ones. It contains almost all of Schauberger's patent information, most of which, even though "lost" originally, is now amplified and explained by Callum Coats. The Trout Motor, the Repulsine, and the rest of Viktor's inventions fall in place like a well stacked deck of cards. You could very

easily build these wonderful engines, yourself (with some help from a good machine shop, of coarse!). If you have waited for the conclusion of the series, your wait will be well worth the time. I highly suggest you pick up this copy. FDG

Here comes one of the newest books on Viktor Schauberger - Hidden Nature, by Alick Bartholomew. Just buy it; it's a great read!



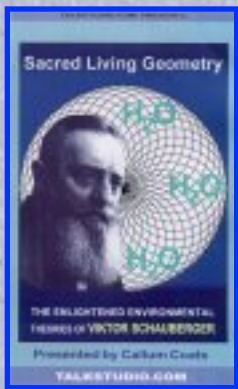

[Sacred Living Geometry:](#)

The Enlightened Environmental Theories of Viktor Schauberger: Our Price: \$39.95

Editorial Reviews: The research of Callum Coats takes us on a journey through the life and inventions of Austrian ecologist Viktor Schauberger (1885-1958). Now, for the first time, you can view the evidence in this detailed, three-hour illustrated lecture presentation on this two video set. Viktor Schauberger was a genius whose ideas were far ahead of his time. He worked as a "forest-master" in the Austrian Alps when they were still a true wilderness. This experience was to influence his entire life's work. Schauberger prophesied the environmental crises we are seeing today, predicting that unless we start to cherish rather than exploit our world, we would surely destroy ourselves. He demonstrated how deforestation would deplete the world of water, causing deserts and climatic chaos. Asked about our technology, "How else should it be done?" His answer was "exactly in the opposite way that it is done today!" His maxim: "Comprehend and Copy Nature!" From his precise observations of the processes of Nature, Schauberger pioneered a completely new understanding of the nature of water as the most important life-giving and energy-empowered substance on the planet. This led him to develop a radical new science which flew in the face of conventional scientific thinking but which, today, is being increasingly recognized for its highly-relevant implications for civilization. Viktor Schauberger might have made a career as a brilliant inventor. Forced, for a time, to develop radical new forms of propulsion for the Third Reich, he went on to work on devices utilizing the principles of implosion - hundreds of times more powerful than conventional power sources. Even in the weeks just before his death, US government and commercial interests were exerting pressure on him to reveal his secrets. Schauberger's deep insights in the special properties of water and nature hold immense implications for future technology and ecology. On VHS tape, two tapes.

[BACK TO INDEX](#)

[[the Telsa & Schauberger Bookstore](#)]

VIKTOR SCHAUBERGER:

[[Water Power - Vortex Theories](#)]-[[Water Power II](#)]

[[Viktor Schauberger -1](#)]-[[Viktor Schauberger -2](#)]-[[Viktor Schauberger -3](#)]-[[Viktor Schauberger -4](#)]

[\[Christian Links\]](#)



UNDERSTANDING WATER POWER



The screenshot shows an Amazon.com product page with a yellow header. The header contains the text "shop now AND SAVE Save big on thousands of products!" on the left, a dropdown menu with "Computers", "Books", "Music", and "DVDs" in the center, and the Amazon logo with "amazon.com and you're done." and "Click Here" on the right. The main content area is purple and lists several books with their covers, titles, authors, and prices. The books are: "Living Water" by Olof Alexandersson... (New \$18.27!); "Living Water" by Olof Alexandersson... (New \$11.95!); "Land der Traumer" by Rene Freund (Used \$9.00!); "Hidden Nature" by Alick Bartholomew (New \$35.00!, Used \$23.00!); "Nature As Teacher" by Viktor Schaubberger... (New \$12.21!); "Living water" by Olof Alexandersson...; "The Schaubberger Companion" by Callum Coats (New \$21.95!); "The Fertile Earth" by Viktor Schaubberger... (New \$13.57!); and "Living Energies" by Callum Coats (New \$17.79!). At the bottom of the page, there is a note "(Prices May Change)" and a link for "Privacy Information".

[shop now](#) AND SAVE
Save big on thousands of products!

Computers
Books
Music
DVDs

amazon.com
and you're done.
Click Here

[Living Water](#)
Olof Alexandersson...
New \$18.27!

 [Living Water](#)
Olof Alexandersson...
New \$11.95!

[Land der Traumer](#)
Rene Freund
Used \$9.00!

 [Hidden Nature](#)
Alick Bartholomew
New \$35.00!
Used \$23.00!

 [Nature As Teacher](#)
Viktor Schaubberger...
New \$12.21!

[Living water](#)
Olof Alexandersson...

[The Schaubberger Companion](#)
Callum Coats
New \$21.95!

 [The Fertile Earth](#)
Viktor Schaubberger...
New \$13.57!

 [Living Energies](#)
Callum Coats
New \$17.79!

(Prices May Change) [Privacy Information](#)

Historical

In 1989 (Vol. 2, No. 1) Raum & Zeit published an article by Ludwig Herbrand, dealing with a development in Water Power, termed in that article the "Herbrand Turbine". While it seems that Herbrand is not the inventor of this technology, the present author nevertheless believes that there is something about water power that present scientific thinking and engineering are not aware of. He believes that the work of the Austrian genius [Viktor Schaubberger](#) holds the key to understanding Herbrand's story.

The sequence of "historical" events that led to Herbrand's discovery is as follows: Herbrand, in the early thirties, was a student of electrical engineering at the Aachen Technical College. The theme that was given him for his graduation thesis was the "Recalculation of the generators in the Rheinfeld power plant." Part of the thesis was also to make a comparison with an article that had appeared in the ETZ technical magazine of 1932, page 233. The power plant of Rheinfeld is a plant that directly utilizes the flow of the Rhein river's water, feeding it through turbines without the use of a dam. The power plant described in the ETZ magazine's article instead was a plant constructed in 1926 at Ryburg-

Schwoerstadt, about 12 miles up river from Rheinfelden. The description was as follows:

"The dam and the power plant's generator building span the width of the river and dam up the water to about 12 meters above the low water side. The driving power is provided by four turbines with an exceptional (for that time) capacity of 250 m³/sec. The power of each generator is 35.000 KVA. The Rheinfelden power plant was an older construction, built in the last decade of the nineteenth century. It had twenty turbines. As the total water flow of the Rhein river at that point is about 1000 m³/sec, each turbine received approximately 50 m³/sec of water. The power of each one of the generators, calculated according to established principles, was 500 to 600 KW, the plant reaching a total power of 10 to 12 MW. However, in this same power plant, some generators had recently been installed that were designed for a much higher power output than the older turbines. They were designed by Prof. Finzi of the Aachen Technical College and constructed by J.M. Voith of Heidenheim/Brenz." A description of these generators was as follows:

"They are built to yield 32.500 KVA and can be run with a 10 % overload indefinitely, thus actually producing 35.000 KVA. The tension is 10.000 Volts at 50 Hertz and 75 rpm, with a factor of cos phi of 0.7. Because of the continuous overload factor, all stresses are kept to a minimum." Herbrand recalculated the wiring of one of these generators and was much astonished when making his comparison to find that these new Rheinfelden generators without a dam and with only one fifth of the capacity (50 m³/sec) produced as much electric power as the huge generators at Ryburg with their capacity of 250 m³/sec and a head water dammed up 12 meters high. He turned to his professor in dismay and Finzi's answer, as related to us by Herbrand, was:

"Do not worry. It is correct. The generator has been working without problems for some time now. Make the calculations backwards and you will see for yourself. We are electrical engineers. Why, those other problems are not ours to solve, we leave them to the water boys. We have repeated our measurements and the generator's yield of power is exactly as specified. The only thing is - no one knows about this."

Soon came the war and circumstances did not permit Herbrand to obtain an electrical engineering job. Only many years later did he remember his graduation thesis and he has tried since then to offer his calculations to government and industry - without success. He also tried to obtain a patent but was refused as his proposal violated the law of conservation of energy, so he was told. These are the "historical" facts of the matter. Without wanting to take away from Herbrand's achievement, it would seem more correct to name the turbine a "Finzi-Herbrand-Turbine", because the actual designer was Professor Finzi, not Herbrand. In any case, Herbrand's great merit is to have come out publicly trying to get the idea used more broadly.

Calculations of yield

The kinetic energy of a water turbine is calculated with the following formula:

$$E_{kin} = m/2 \cdot v^2 \text{ (KW)}$$

m is the usable amount of water measured in m^3/sec and v is the velocity of the water, expressed in m/sec .

Generally, v is calculated by the use of the following formula:

$$v = \sqrt{2 \cdot g \cdot h}$$

whereby g is gravity with $9.81 m/sec^2$ and h is the difference in level between the head water and the water on the lower side expressed in meters.

But here the matter becomes critical and we should clearly understand that the latter formula is only a secondary formula to find a v -equivalent in the special case of gravitational water pressure resulting from a difference in water levels. For the calculation of v in flowing water this formula is neither usable nor necessary. The velocity of flowing water can be quantified by direct measurement.

The important concept here is that water can gain its velocity in two distinctly different ways.

Water can be held up by a dam and at the point where we release it through a nozzle or say through a turbine, it will experience a strong acceleration. The resulting velocity can be calculated by use of the above formula.

If we take for instance a difference in water levels of 12 meters, we get a velocity of the water of

$$\sqrt{2 \times 9.81 \times 12} = 15.34 \text{ m/sec}$$

Should the capacity of flow be $250 m^3/sec$ then we get a kinetic energy of

$$250/2 \times 15.34 \times 15.34 = 29,414 \text{ KW,}$$

approximating the above description of the generators of the Ryburg-Schwoerstadt power plant.

The second way in which water may reach a certain velocity is the normal flowing of a river and in particular the natural vortex movement of water.

In our example of the Rheinfelden power plant, the velocity of water flow through the turbine was $35 m/sec$, much higher than in Ryburg-Schwoerstadt.

This higher velocity of flow was reached in two stages. A small island located in midstream provided the means for the first increase in velocity, as the water was forced to flow on one side only of the island. The water, finding itself in a much more narrow bed, increased its velocity of flow. A further increase was achieved by a funnel-like construction of the inlet towards the turbine, restricting the diameter of the water's flow even further and increasing the velocity so as to pass the turbine at a considerable $35 m/sec$ (approximately 80 mph).

So the kinetic energy, in accordance with our first formula as given above, was

$$50/2 \times 35 \times 35 = 30,625 \text{ KW}$$

We see that with a fifth of the amount of water per second, but with a considerably increased velocity of flow, the same kinetic energy can be obtained as with 250 m³/sec and a water level difference of 12 meters. If we wished to obtain an equivalent of $v = 35$ m/sec through gravitationally induced water pressure, we would need a dam 62.4 meters (nearly 200 ft!) high. How is it possible that by simply restricting the space in which water may flow, we can free such tremendous energies?

Herbrand has calculated the effect of contraction by introducing a factor n . He found that an increase of the factor n , that is, a greater contraction, will increase the energy of the water but he has come to recognize that this concept is impossible to grasp for our scientific "experts".

Viktor Schaubberger: "We are using the wrong kind of motion!"

The Austrian forest warden and inventor Viktor Schaubberger has researched and successfully applied the laws of motion of water. He said that we are using the wrong kind of motion, referring to all of our technological "achievements", from the internal combustion engine to our way of putting streams of water into an unnatural straitjacket. In order to understand the discovery of Herbrand, it is important to know that the natural motion of water is a centripetal vortical movement, turning or "rolling" inward around the axis of motion of the water's flow. This kind of motion tends to accelerate and contract the stream of water, accumulating kinetic energy in the form of an increased velocity.

A simple example for this is the vortex that forms when a bathtub is emptied of water. We can also observe the same kind of motion on a simple tap of water. In fact, if the water leaves the tap without disturbances such as bubbles of air or other disturbing flows, we see that the water takes a spiral course, accelerating and contracting on its way. Anyone who has doubts as to the fact that the natural spiral movement can increase the kinetic energy of water, need only remember the extraordinary energies contained in tornadoes and hurricane winds. These energies are accumulated by just the same spiral movement.

In the early years of his career as a forest warden, Schaubberger has utilized this effect to allow the transport of heavy beech wood logs in wooden water sluices, very much to the amazement of his seniors and visiting scientists. Science at that time, just as today, could not explain how it was possible to transport beech logs in a flow of water, as the wood of the beech tree has a specific weight higher than that of water. Considering this, it is no wonder that also Herbrand's observations were to meet disbelief and even outright hostility from our scientifically educated "experts".

Thermodynamics and the Law of Conservation of Energy

This discussion about Rheinfelden and Herbrand's turbine lets us fly square into the teeth of recognized authority. We are seemingly violating the hallowed principle of the conservation of energy. I say seemingly, because all things considered, conservation of energy is assured. Just that a stream of

water is not a "closed system" as our scientists would like to believe. In fact, there are no real closed systems in this world and thus thermodynamics, at least its second law, as well as the law of conservation of energy, are not correct as currently stated. The author has dealt with the basic assumptions of physics and the law of conservation of energy in a previous article.

Gravity and Inertia

In closing I would like to point out that gravity and inertia, although they do show analogous effects, are not identical. Even though we cannot subjectively distinguish the earth's gravity from an acceleration of 1 g (9.81 m/sec²), say in a spacecraft, when we talk about water we must distinguish well between gravitation and inertia. A mass of water held up by a dam is a mass which under the influence of gravity exerts a certain pressure and thus is able to drive a turbine. The energy utilized in this case is mostly the gravitationally induced pressure, not the inertial force that comes from motion. A moving mass of water has an inertial mass which by force of inertia is able to drive a turbine. In this case, the force we are predominantly using is a direct result of the velocity of motion. The difference here lies in the natural or unnatural motion of the water.

According to current scientific knowledge we hold up the water by a dam, thus stopping its natural flow and losing the inherent inertial forces, in order to use the gravitational pressure of this now motionless mass of water to drive turbines. It would be much more effective to use the natural motion of water and, if possible, to accelerate that motion, in order to gain more energy out of a fast flowing mass of water than we could ever get out of a dammed-up motionless mass, because

$$E_{kin} = m/2 \cdot v^2$$

In other words, ***the kinetic energy increases with the square of the velocity!***

Schaubberger has explained the principles of motion to us, Prof. Finzi has built the turbine and Herbrand has recognized the paradox and has tried to bring it into the public domain. How long will it take us to finally understand that in our technological solutions we must work with nature and not against it?

Schaubberger had a word for this (freely translated): "Observe, understand and then copy nature."

Note: This page was originally created by, and is used, in part, with exclusive permission from Josef Hasslberger. It has been edited for content. You may visit the original webpage at <http://www.hasslberger.com>, where you will find even more documentation on the vortex theories proposed by Viktor Schaubberger. It is a very well laid out site.

THE VORTEX

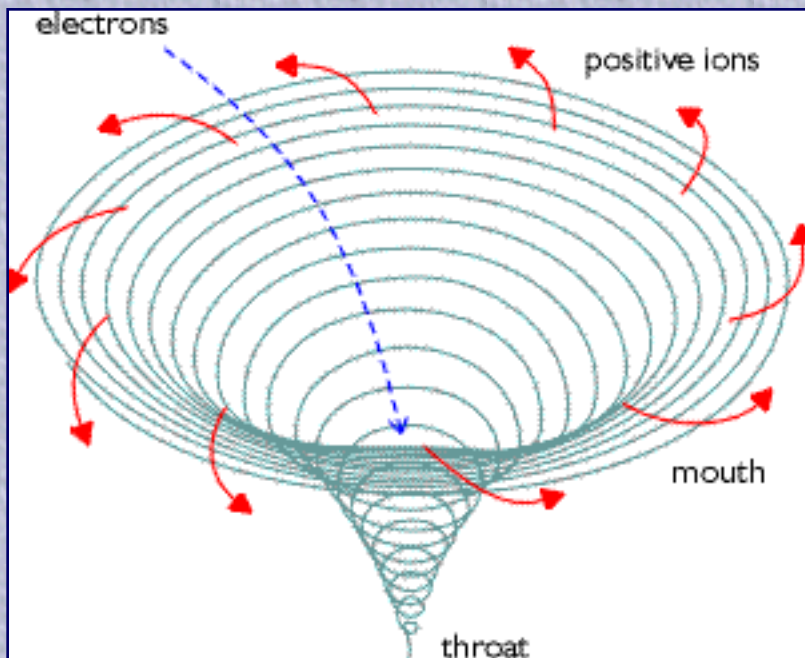

The centrifugal effect in a vortex throws heavy liquid/air out to the perimeter whilst lighter air/liquid is pushed to the center. Electrically, the air polarized with negative ions or as electrons will be pushed to the center and down, the air with positive ion content will move upward and outward. With mass weights for an electron at 9.109×10^{-31} kg. and a positive ion of air at around 2.656×10^{-26} kg it can be seen that the negative electron can be only one thirty-thousandth of the positive ion, and of course much more agile.

Latent Powers at Molecular Level

Professor J.H.Jeans¹ writing about electrons, particularly of the innate strength of their

negative charge wrote: "According to the best recent determinations, the amount of this charge is 4.774×10^{10} electrostatic units, while the mass of each electron is 9.00×10^{-28} grammes. These determinations, which are due to Millikan and Bucherer, are probably accurate to about one part in a thousand. To a lower degree of accuracy the radius of the electron is probably about 2×10^{-13} cms. We can form some conception of the intense concentration of mass and electrification in the electron by noticing that a gramme of electrons, crammed together in cubical piling, would occupy only 7×10^{-11} cubic centimeters, while two such grammes of electrons placed at a distance of a meter apart would repel one another with a force equal to the weight of 3×10^{22} tons.

The electric force of repulsion outweighs the gravitational force of attraction in the ratio of 4.2×10^{42} to one."

Similar to how Viktor Schaubberger's aerodynes utilized levitation thrust the ufo-type expulsion energy is a *created reaction* to the comprehensive densation of the air that is continually being sucked in through the vortex and therefore making the air below the craft more dense than the air above the craft. In other words the vortex is to create a **higher-pressure area below the craft** and a lower-pressure area above the craft.

But in this case, in the center of the accumulator reactor there are various constrictive devices in operation that are preventing the highly turbulent implosion cycloid, or vortex, from **outflowing**. Expulsion, then, cannot occur unless by force. Once it does expulse, when it reaches a certain threshold and the repulsion force takes over, the release would be sudden and very powerful - the highly compressed energy will immediately expand, once it has passed through the hole, or the circumferential duct, into the surrounding atmospheric air to regain its normalized state.

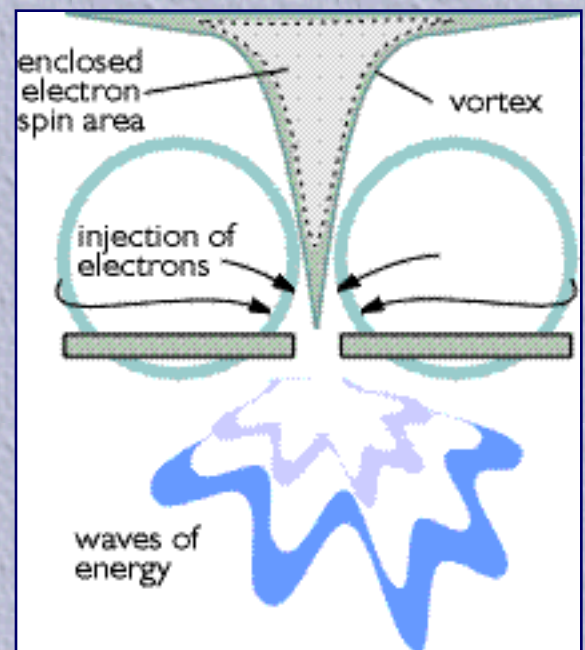

The usual hue of the energy around an electro-aerodyne is blue, which of course is the atoms / electrons accelerating and decelerating and then normalizing. The 8Hz (or 8 times per second) frequency that sometimes accompanies the whirling sound some observers have heard around these electro-aerodynes when just hovering may be one of the low-speed strobing cycles for that mode of energy output, the main pulses of which would be radiated at a much higher frequency (a **strobed** energy cycle occurs when two or more higher frequency pulses are propagated in close proximity).

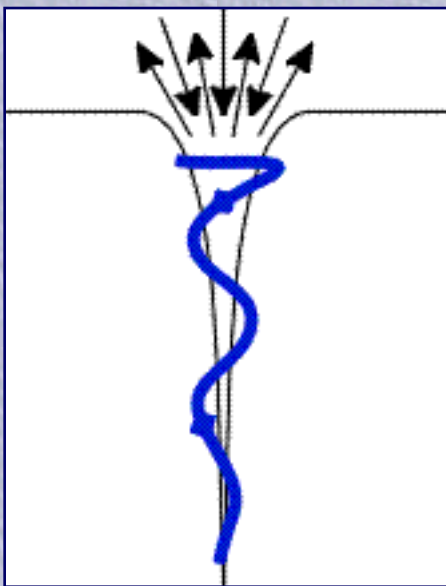

A vortex has centripetal (as well as centrifugal) force that can compress its fluid to such a degree as to result in a 350,000-fold increase in pressure or a powerful implosive suction force.² A vortex can be considered as a wave of ever-diminishing amplitude. And as a type of black hole, where energy is drawn in and by extreme compression is polarized electrically, so that particles sucked in split into electron/positron pairs, and where, as according to Hawking's Theoretical Physics³ there is an emission - even from black holes in space - of both positive and neutral charges. Correspondingly, there is at the mouth of a vortex a relative centrifugal force which is positively charged with respect to its central (negative) throat.

[Viktor Schaubberger](#), the Austrian physicist, and Patrick Flanagan ("**Secrets of the Soil**" p99-115), have both found that water when revolved at high revolutions creates a substantial potential-difference

in electrical energies in its structure.

According to the research of T.J.J. See in his **Wave Theory: Discovery of the Cause of Gravitation** (1938-52) the molecular structure of air or water (or indeed any fluid) changes quite dramatically at a critical point of inter-atomic-spacing where the normal forces of attraction transpose to an opposing force of repulsion...

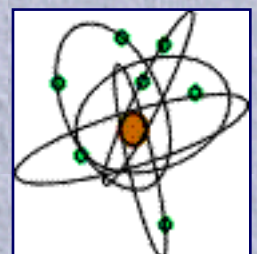

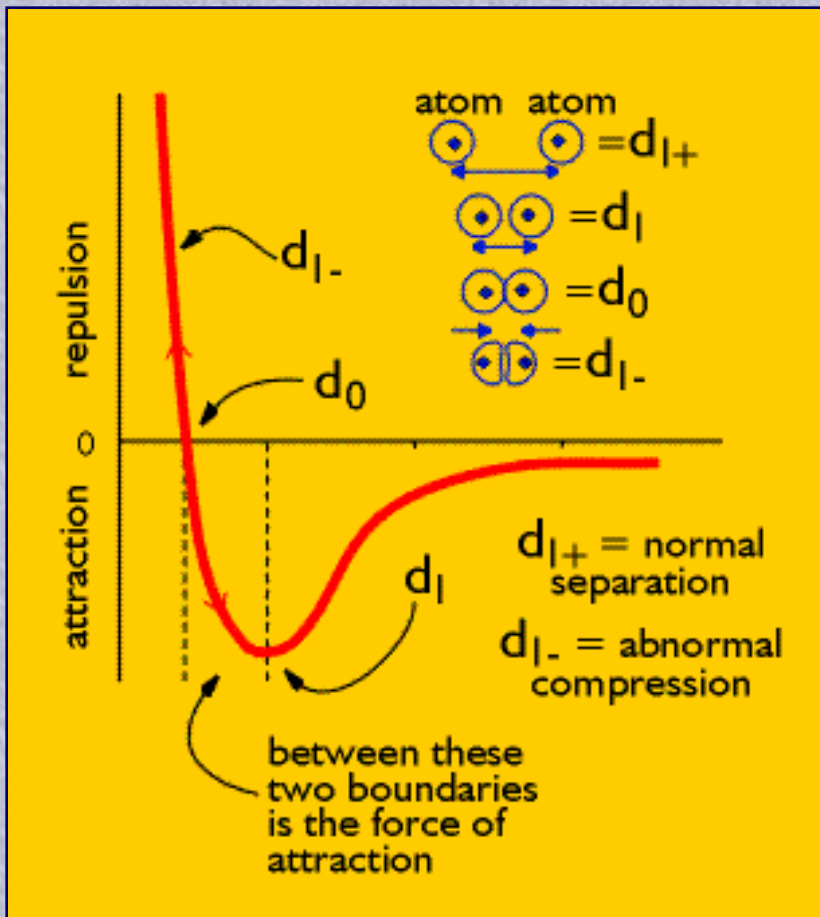

Between the atoms and molecules that make up liquids and air a balance is maintained where electrons orbit a nucleus of an atom in precisely defined shells. **Electron shells of one atom cannot mesh with those of other atoms - if they could the whole world would collapse into a very tiny ball!** Obviously there has to exist an all-powerful mechanism that can dramatically, if needs be, get the atomic and molecular structures out of a tight corner. So when the inter-atomic spacing between orbit shells is too tightly compressed a repulsion occurs to force things back toward normality. As the chart shows, when atoms get to a certain closeness, between d_l and d_0 they undergo an attraction to each other - but further compression beyond d_0 is met proportionally with repulsion. If there were a situation where the atomic structures were forced momentarily through a constriction that resulted in an ultra-high compression d_{l-} .

then the repulsive forces would be very powerful indeed.

Viktor Schauberger was one researcher that utilized this phenomenon with his **Implosion** motive power - he found the way, a very simple way, to compress the atomic structure of a flowing fluid - to this ultra-high compression level, and facilitate its resultant expansion, its released **REPULSION** energy, so as to create a **low-density area** above the craft which it would simply rise up into.

This area in the center is essentially to create a constriction to the build-up of vast amounts of charge, to retain it, so that only when a certain threshold has been reached will the charge forcibly blast its way through it.



¹ "The Mathematical Theory of Electricity and Magnetism" J.H. Jeans (1920) p20

² For an interesting account of the pressure-changing forces of the vortex see "The Energy Evolution" (Viktor Schaubberger) edited by Callum Coats (2000).

³ While this is theorized by Stephen Hawking in "A Brief History of Time", Stephen also postulates a theory that gravity is linked to electrostatics, although I would think, surely, that it is more likely that gravity is a vortical reactive energy, especially as the planets are themselves held in space by vortical motions.

Strangely enough mainstream science has more than anything ignored the vortex, Hermann von Helmholtz back in 1858 wrote a mathematical paper on it called "On The Integrals of Hydrodynamic Equations to Which Vortex Motions Conform". Viktor Schaubberger made extensive discoveries to do with vortex energy and engineered several over-unity generators (1945). T.J.J. See wrote of stellar vortical movements in his "Wave Theory: Discovery of the Cause of Gravitation" (1938-52). T. Townsend Brown tackled the complex mathematics to do with the vortical motion of ionized air due to electro hydrodynamic forces around his 'Tri-arcuate Ballistic Electrode' craft (1960). And more recently researchers have discovered that insects (and birds) actually fly by creating vortical motions between their wings and the surrounding air. See the articles in "Nature" (19/26 Dec 1996) Vol 384 p626-630: and "New Scientist" (11 Oct 1997) p24-27.

Books from Amazon.com on Viktor Schaubberger:

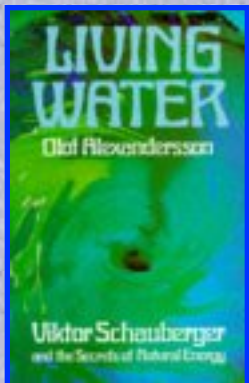

The original translation of Viktor Schaubberger's work, "[Living Water](#)", by Olof Alexanderrson...start here, and get each one in order. This is an excellent, brief introduction to the thought of Viktor Schaubberger, and I hope it inspires works which are more complete. Callum Coates' books reach in this direction, but what is really needed are more people to read these books, synthesize their information, and come up with new and original books which take us further into depth in these areas. This will probably involve synthesizing the work of Schaubberger, Grander, Bienveniste, and others. An understanding of Schaubberger is very important for those attempting to reconstruct an Indigenous European Perspective. Schaubberger has the elements of a modern water shaman, and his shamanic / intuitive techniques of letting his body float with the water should be closely correlated with what Hans Peter Duerr has to say about "out of body" experience in his tome "Dreamtime". Although Schaubberger lived in the 20th Century, his perspective allows us to imagine back what earlier indigenous practitioners may have been like. The Colonial, Imperialist Europe is only one side of the coin of Europe. We must also include the suppressed indigenous, pagan, and green sides. Significantly, the Inquisition represents a watershed in European history where a great deal of the indigenous healers and theorists were wiped out in holocaust proportions. An understanding of Schaubberger, coupled with an appreciation of Steiner, Hildegard of Bingen, Hans Peter Duerr, and others, will allow us to reconstruct what a noncolonial, nonimperialist Europe was like. Understanding water's nature is essential in this regard, for water forms the basis of our understandings of flow. Furthermore, understanding water's energetic qualities will help us understand how it interacts with the body. Traditional Chinese Medicine, for example, would benefit from an accurate and holistic understanding of water's qualities. In short, this book is an excellent appetizer.

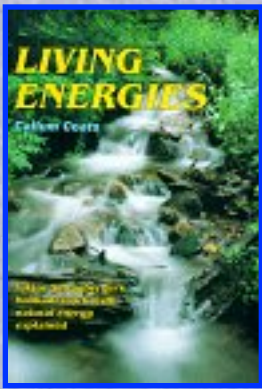

The book that started it all...[Living Energies](#), Callum Coats first Viktor Schauberger book. If you only buy one book, this would be the one to get. Fantastic. Living Energies, May 23, 2001

Reviewer: Frank D Germano, from Tafton, PA United States: This book started it all! Callum Coats basically brought to "light" the resurgence of interest in Viktor Schauberger's theories. This is truly a brilliant work. Water as a carrier of vital energy information, trees as bio-condensers of energy between the deep earth and the sun, how self-cleansing rivers nourish the landscape, how the future of the earth

depends on the replanting of natural forests, revolutionary agricultural implements, free energy heater-coolers, jet engines and gravity defying machines invented by Schauberger in the 30's and 40's, home power generators...it's pretty much all here. It was a hard book for me to put down once I started reading, and I go back to it continually for reference. This book pretty much sums up Schauberger's work, which Coats then compartmentalized and expanded in the "Eco-Technology" series with four other books. I would highly advise getting this book, first, and reading it thoroughly, before moving on to the series, as it is a fascinating preface into discovering who Viktor Schauberger WAS, and learning just how far-reaching his theories were, and applicable to us, today. FDG.

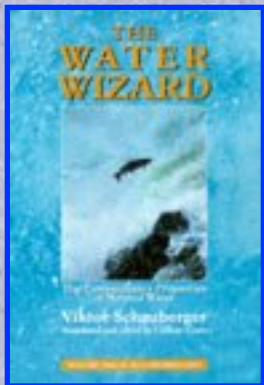

1.) The first book of the "Eco-Technology series" - [The Water Wizard](#) - This book gives a lot of history on Schauberger. The nature of water, May 23, 2001

Reviewer: Frank D Germano, from Tafton, PA United States: This is the first book of the "Eco-Technology" series, and as so, gives you the foundation of the theories presented by Viktor Schauberger, and amplified by Callum Coats. It DOES contain quite a lot of previous information written in Living Energies (Coat's first Schauberger book), however, the discussion and the text is much more thoroughly covered. The substance of water, water supply, deep-sea water, the consequences of drinking

purely mechanically treated water, notes on the secrets of water, high-frequency water, the pulsation and healing power of water, river regulation, groundwater tables, temperature and movement of water... notice my use of the word WATER. Yes, this book is about water, but, by reading it, just wait until you discover what you DID NOT know about "water". It is a very good start, and as I said, a foundation for understanding the theories of Viktor Schauberger. FDG.

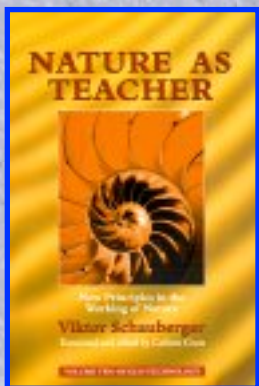

2.) Part two of the "Eco-Technology series" [Nature As Teacher](#), A great book on living with nature. A very nice read.

Our Senseless Toil, May 23, 2001: Reviewer: Frank D Germano, from Tafton, PA United States: I had to use a title from one of the books' opening chapters. This book is going to annoy some people. Callum Coats presents Viktor Schauberger's theories in a modern light. The laws of Nature, Questions for Science, Nature as Teacher, the fish-eagle, the swing, the trout, the ox, dancing logs and stones, the Genesis of water, the coming bio-technical age, the secret of the egg form...these are

elucidated...then comes the fun stuff... the age-old secret of the atom, implosive breathing, life-force and animated breathing, is there perpetual motion (?), organic syntheses, the false world view, the mechanical equivalent of heat, plasmolytic motion; this volume gives tremendous insight into what is

happening in the world, today, and practical solutions on HOW we may yet save our world. Most telling is Schaubberger's inane gut feelings on the powers at work in the environment, and living water. Hey, it's only volume two of the series. Get all four, and see how these books will influence YOU to change the way we look at the earth . FDG

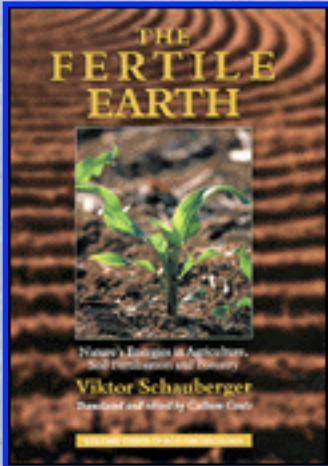

3.) [The Fertile Earth](#) , part three of the "Eco-Technology series. Pure drinking water, how to make it, the benefits produced in the body...the natural flow and paths of rivers, and how man has disturbed nature...organic, natural farming...trees as the life giving force on the earth...it's all hear! Are you trying to save Mother Earth?, May 23, 2001

Reviewer: Frank D Germano, from Tafton, PA United States: If you are in any way interested in the environment, then this book will appeal to you. This is the third book in the highly acclaimed "Eco-Technology" series by Callum Coats.

Not only does the book delve into what man is doing to harm the environment, it also offers "fresh" ideas on what we can and should DO about it. I can't believe "Green Peace" or some other pro-environmental group doesn't have this book as part of their by-laws! Fascinating. Of coarse, the entire book is based on the revolutionary work of Viktor Schaubberger. This one, if you are into farming, just have a back-yard garden, or are a hard core pro-earth person, will keep you reading till the end...and want to read the entire series. A very well written and inspiring book. A different view of natural phenomena, the influence of temperature and water movement, forestry, agriculture, the energy industry, the dying forest, timber and water in the building industry, soil fertilization, increased productivity...wow! Again, whether you are just into learning what's happening to the earth, and why, or you are serious about trying to DO something to stop the damage already done, this book will open your eyes. FDG

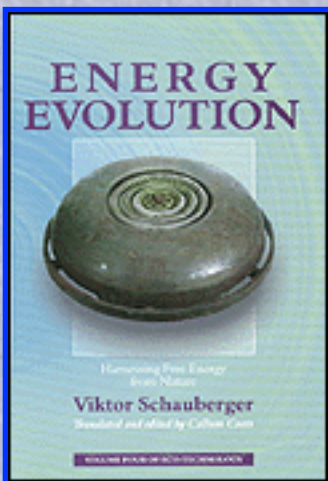

4.) [The Energy Evolution](#) , the final book of the "Eco-Technology series" (If you are interested in the designs and patents on Schaubberger's devices, this is the book. Culmination of the Eco-Technology Series, May 23, 2001

Reviewer: Frank D Germano, from Tafton, PA United States: This book, being the fourth and last of the Eco-Technology series, is an incredible finish. Naturally, all of the book deals with Viktor Schaubberger, and his theories on living water, and the environment. This book, however, goes deeper into the actual inventions than the previous ones. It contains almost all of Schaubberger's patent information, most of which, even though "lost" originally, is now amplified and explained by Callum Coats. The Trout Motor, the Repulsine, and the rest of

Viktor's inventions fall in place like a well stacked deck of cards. You could very easily build these wonderful engines, yourself (with some help from a good machine shop, of coarse!). If you have waited for the conclusion of the series, your wait will be well worth the time. I highly suggest you pick up this copy. FDG

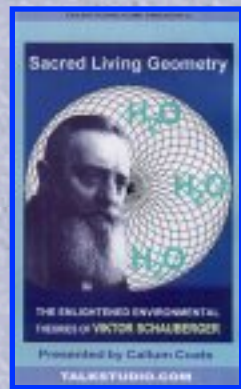

Sacred Living Geometry:

The Enlightened Environmental Theories of Viktor Schaubberger: Our Price: \$39.95

Editorial Reviews: The research of Callum Coats takes us on a journey through the life and inventions of Austrian ecologist Viktor Schaubberger (1885-1958). Now, for the first time, you can view the evidence in this detailed, three-hour illustrated lecture presentation on this two video set. Viktor Schaubberger was a genius whose ideas were far ahead of his time. He worked as a "forest-master" in the Austrian Alps when they were still a true wilderness. This experience was to influence his entire life's work. Schaubberger prophesied the environmental crises we are seeing today, predicting that unless we start to cherish rather than exploit our world, we would surely destroy ourselves. He demonstrated how deforestation would deplete the world of water, causing deserts and climatic chaos. Asked about our technology, "How else should it be done?" His answer was "exactly in the opposite way that it is done today!" His maxim: "Comprehend and Copy Nature!" From his precise observations of the processes of Nature, Schaubberger pioneered a completely new understanding of the nature of water as the most important life-giving and energy-empowered substance on the planet. This led him to develop a radical new science which flew in the face of conventional scientific thinking but which, today, is being increasingly recognized for its highly-relevant implications for civilization. Viktor Schaubberger might have made a career as a brilliant inventor. Forced, for a time, to develop radical new forms of propulsion for the Third Reich, he went on to work on devices utilizing the principles of implosion - hundreds of times more powerful than conventional power sources. Even in the weeks just before his death, US government and commercial interests were exerting pressure on him to reveal his secrets. Schaubberger's deep insights in the special properties of water and nature hold immense implications for future technology and ecology. On VHS tape, two tapes.

Two Products That I Endorse are the "Electron 3 & 4 Living Water Machine" and the "Wellness Filter Line":



FutureTech Today introduces the [Electron 3 & 4 Living Water Machine](#). This machine is being marketed through Future Tech Today, made by "For Health Reasons" of Chicago Illinois, USA. (makers* of quite probably the best water filtration system, based on victor Schaubberger's ideas, of coarse, on the planet! Purer Distilled Drinking Water:

When vapor turns to rain, it passes through temperature gradients where the temperature is continually changing with oxygen. This process stretches and contracts the H bonds that hold the molecules together...this creates ENERGY! Plant diseases are caused by viruses and bacteria, and our method of autoclaving them, using INTENSE HEAT, DESTROYS THEM (NOT just boiling).

The research chemist and others spent thousands of dollars on every product on the market, and

ONLY OUR METHOD prevented the diseases in plants and caused incredible growth by just dropping plant buds in the water. Root growth 2 1/2 inches long compared to 1/8 of an inch in any of the others during the same time frame...even compared to water with nutrients added to the it!! This test was REPEATED over a period of three YEARS ...so there is no mistake!. The BOTTOM LINE is that today's ordinary water is DEAD! Why would ANYBODY want to use DEAD water, and yet most people do! If you can afford the rather steep price of their units, it is well (no pun intended!) worth the price, from personal use, on my end.

*The company that originally produced this unit is listed below - "For Health Reasons" of Chicago, IL. The company SELLING (marketing) the unit is [FutureTech Today](#)... "Future Tech Today was founded in 1998 with ambitions to break the latest energetic healing technologies to the general public while maintaining a research and development program allowing them to bring tomorrow's technology today. The idea was to represent the latest technological research in the fields of energetic medicine, water vitality, and EMF (electro-magnetic field) protection products. They represent products and technologies from all over the world, many of which are in very early stages of production or still in research phases; in this way they give the general public a preview of technologies to come..." (from their website, and used here for endorsement sake) FDG

water-revitalizer.com

ozonedetox.com

rife.biz



[FutureTech Today introduces the Wellness Filter!](#) This is the **Wellness Filter®**, and comes in various sizes to suit individual needs. In my humble opinion - it's the best on the market, today. Pricy, but well worth it. Again, this product is offered through FutureTech, Today. For website info, use either their link - [FutureTech Today](#) - or <http://www.wellness.com.au> (If you go to wellness.com.au directly, you can even become an associate, an affiliate, or a partner-type program with them if you meet their strict company requirements).

"The Wellness Filter® offers you and your family a quality of water that Nature has provided to only a select few. By using natural purification processes in combination with advanced technology, the Wellness Filter® produces what many believe is the best drinking water on Earth. The Wellness Filter® not only removes harmful contaminants but it also enhances the water through a patented process that creates a quality of water beyond the reach of conventional water filters. Clean water plays a vital role in your health, fitness and appearance..." (from the FutureTech Today website).

[BACK TO INDEX](#)

[[the Telsa & Schaubberger Bookstore](#)]

VIKTOR SCHAUBERGER:

[\[Water Power - Vortex Theories-\]](#)[\[Water Power II\]](#)

[\[Viktor Schauberger -1-\]](#)[\[Viktor Schauberger -2-\]](#)[\[Viktor Schauberger -3-\]](#)[\[Viktor Schauberger -4-\]](#)

[\[Christian Links\]](#)



WHO WAS VIKTOR SCHAUBERGER ?

Viktor Schauberger (6/30/1885 - 9/25/1958)

[[PAGE ONE](#)][[PAGE TWO](#)][[PAGE THREE](#)][[PAGE FOUR](#)] [Implosion Technology](#)][[Vortex Science](#)]
[[Help Frank Germano](#)]

I've broken the section on "Viktor Schauberger" up into **Several** distinct parts. Please take the time to view each page, in the order presented.

- Page One -

Viktor Schauberger; Time-Line Biography:

- 1885 Viktor Schauberger was born on June 6th in Holzschlag, Mühlviertel region, in Upper Austria.
- 1914 Shortly after the birth of his son Walter he was called up for military service (First World War 1914-1918).
- 1919 Junior forest warden, senior forest warden, game keeper;
- 1920 - 24 head warden of the forest and hunting territories in Brunnenthal/Steierling, district of Kirchdorf/Krems in Upper Austria, under Prince Adolf von Schaumburg-Lippe.
- 1922 Schauberger designs and builds timber flotation installations in Steierling, based on his observations of nature. Reduces logging costs to one tenth. Promotion to "Wildmeister".
- 1924 Imperial adviser on timber flotation installations
- 1926 [Timber flotation installation in Neuberg an der Mürz/Styria](#)
- 1928 Construction of further flotation installations in Austria, Yugoslavia and Bavaria.
- 1929 [First applications for patents in the fields of water engineering and turbine construction.](#)
- 1930 Film "Carrying Water" (Tragendes Wasser) about the log flumes in Neuberg.
- 1931 Experiments with extracting electrical energy directly from water (Water Capillary Research)
- 1932 Production of Pure Water; fuel production from water.
- 1933 Publication of his first and only book "Unsere Sinnlose Arbeit" ("Our Senseless Toil") in Vienna.
- 1934 Meeting with Hitler, discussion about fundamental principles of agriculture, forestry and water engineering. Schauberger refuses to work for the German Reich.

- 1935 Application for two patents: "air turbine"; "procedure for lifting liquids and gases".
- 1937 The "warmth-cold machine", constructed for Siemens, melts in an unauthorized test run.
- 1938 He instructs his son Walter to repeat the Water Capillary Research (Lord Kelvin's Falling Water Experiment): A voltage of up to 20.000 volt is achieved.
- 1940 Construction of the "Repulsine" in Vienna
- 1941 An intrigue caused by the Viennese Association of Engineers resulted in Schauberger's enforced confinement in a mental hospital in Mauer-Öhling and in continuous observation by the SS. In Augsburg, Schauberger works with Messerschmidt on engine cooling systems. Correspondence with designer Heinkel about aircraft engines.
- 1942 Start of the "Repulsine" which shattered to pieces on setting it in motion
- 1943 Further development of the "Repulsine". The aim is to develop a submarine engine.
- 1944 [Continuous development of the "Repulsine" at a Technical College of Engineering at Rosenhügel in Vienna.](#)
- 1945 Schauberger starts to work on his "Klimator". After the end of the war, observation of his work by the American occupying forces and confiscation of all his devices and materials. Transfer to Leonstein in Upper Austria.
- 1947 Construction of further "water refining apparatus" in Salzburg.
- 1948 Co-operation with the company Rosenberger in Salzburg concerning the production of apparatus for soil cultivation ("Golden Plough"). Schauberger invents the "Spiral Plough".
- 1950 Taking out patent on "Apparatus for soil cultivation made of copper".
- 1952 Tests with "spiral pipes" at the Technical College in Stuttgart. Schauberger proves his theory that different materials used in pipes influence the friction of the various fluids. Further tests with copper ploughs by the agricultural research institute in Linz.
- 1954 Development of the "suction spiral", the centrepiece of the so-called Heimkraftwerk ("Home Power Generator") which was demolished during the first test run due to regulatory failure.
- 1955 Publication of the book "Implosion statt Explosion" ("Implosion instead of Explosion") by Leopold Brandstätter.
- 1957 Co-operation with the company Swarovski from Tyrol. Construction of more Home Power Generators. Problems regulating the number of revs can't be solved.
- 1958 An American consortium offers financial means for practical experiments with ["Implosion Energy"](#). Visit to Texas with his son Walter. Return to Austria after a heavy dispute. Schauberger was forced to sign an agreement, forbidding him any further research with Implosion. All documents, models and equipment are left behind in the USA. Five days after his return, Viktor Schauberger dies on September 25th ...Viktor's Children: Walter, Margarete, Huberta

Viktor Schauberger: The Father OF Implosion Technology



Schauberger could be called the ***father of implosion technology***. The [implosion principle](#) is, of course, diametrically opposite to what today's ***explosion*** oriented technology utilizes. ***Implosion*** has to do with a self sustaining vortex flow of any liquid or gaseous medium, which has a concentrating, ordering effect and which decreases the temperature of the medium, in opposition to the dictates of "modern" thermodynamics.

Viktor Schauberger constructed water sluices, which, with controlled water temperature and vortex flow, were able to transport logs of a higher specific weight than would normally allow their transport on water. He proposed a more effective means of utilizing hydroelectric power by his jet turbine (see my article [Water Power](#)). In the second world war he was forced to develop his

concepts of vortex dynamics at the service of Hitler's military goons, and, is said to have produced working prototypes of [levitating disks](#) using these principles. At the end of the war, the remains of his work fell partly into Russian, and American, military hands. After the war, Schauberger worked on a concept of water-based power generation, through vortex action, in a closed cycle engine. In 1958 he was brought to the USA, by promises of a possibility he would get his technology further developed and applied. Afterwards, he was thoroughly debriefed, his writings and prototypes were kept, and, he apparently had to sign a legal document and 'promise' not to promote his technology further - all so that he would simply be able to return home to Austria. Five days after his return to Austria - on 25 September 1958 - he died. A book that details some of the life story of Schauberger was written by Olof Alexandersson. The title is ["Living Water"](#), available below, through "AMAZON.COM."

Viktor Schauberger And His Work -

Olof Alexandersson, a Swedish engineer and anthroposophist, wrote the first popular introduction to the radical ideas of Viktor Schauberger, entitled ***Living Water***. It is now in its eighth printing and has inspired many to go on to Callum Coats' in-depth study of Schauberger's ideas, ***Living Energies***, which was published in 1996. Callum had met Viktor's son, Walter Schauberger, in 1977 and was to spend three years studying with him at his "Pythagoras-Kepler System Institute" in Lauffen, in the Salzkammergut near Salzburg. During that time, Callum was given access to all Viktor's writings.

Viktor Schauberger did not start to seriously write about his ideas and his discoveries until the age of 44, when he acquired a distinguished sponsor in Professor Philipp Forchheimer. As Coats describes later in this volume, Forchheimer, a world famous hydrologist, had been asked by the Austrian Government to report on Schauberger's controversial log flumes, which transported large amounts of timber from inaccessible locations without damage. He was so impressed with Schauberger's discoveries that he asked him to write a paper which was published in 1930 in ***Die Wasserwirtschaft***, the Austrian Journal of Hydrology. This paper

attracted the attention of the President of the Austrian Academy of Science, Professor Wilhelm Exner, and resulted in a commission to write a more detailed study of his theories for that same magazine under the title ***Temperature and the Movement of Water***.

Schauberger's ideas completely flew in the face of conventional ideas of hydrology and water management and, as a result, gained him many enemies in scientific circles. The reason Viktor developed the strong feelings about orthodox scientific research that you will read in this and subsequent volumes was partly to defend himself from their attacks, and partly out of his despair at witnessing the ongoing destruction of the natural environment by their blind and uncaring technologies. It was this despair that motivated him to write his only book, ***Our Senseless Toil - the Cause of the World Crisis***. It was published at a time of severe depression, when many were worried about the future.

After Forchheimer died, Schauberger found another ally in Professor Werner Zimmermann who encouraged Viktor in 1935-1936 to write about the damage being wrought to the great rivers, the Rhine and the Danube, in a small 'new thought' magazine *Tau*. After Schauberger's death, two magazines published further collections of Schauberger's writings: ***Implosion*** was started by a student and collaborator of Viktor's, and published a number of his articles in the 1960s. ***Mensch und Technik*** in the 1970s published articles by and about Viktor Schauberger for the more free-thinking scientific community.

Callum Coats has skillfully woven together these articles, together with correspondence with other scientists, friends and officials of one kind or another, into a fascinating tapestry which gives a true and very readable account of Schauberger's impassioned campaign to alert the world to the dangers of the prevailing scientific dogma. Unfortunately, not much has changed, and Schauberger's vision of how humanity could work cooperatively with Nature is perhaps more relevant than ever.

Callum Coats arranged this massive amount of material into a large volume, called the ***Eco-Technology Series***. In considering this for publication, they realized that it would be much more accessible in several volumes, arranged by theme. This first one, ***The Water Wizard***, is devoted to Schauberger's ideas about water and rivers. The second, ***Nature as Teacher***, concerns the wider implications of his ideas on water and energy. The third, ***The Fertile Earth***, describes the way trees transform energy, and processes of fertilization of the soil. The final volume, ***The Energy Revolution***, gathers together the discussion and description of Schauberger's appliances for purifying and energizing water and for producing vast amounts of virtually free energy. Together with ***Living Energies***, the ***Eco-technology*** series give a complete account of the vision and genius of one of the founders of the present ecological movement, and are an inspiration for all those who wish to see our precious Earth saved from extinction by short-sightedness and greed, and the emergence of a new partnership with bountiful Nature. You can view and purchase all of these books through "AMAZON.COM", and will find the links to each book at the bottom of this page.

This entire section on Viktor Schauberger would not be possible without the tremendous amount of work put forward by Callum Coats, and to that we owe a debt of gratitude. Most of the following sections have been transposed from various websites and compiled for your viewing. Several sections were sent to me as email attachments

and I have no way of knowing who the original author is. If there are any copyright infringements, please inform me and I will either post a "used with permission" addendum or remove the script in question entirely.

The Natural Eco-Technological Theories of Viktor Schauberger

Viktor Schauberger (30 June 1885 - 25 September 1958) was born in Austria of a long line of foresters stretching back some four hundred years. He developed a gift for accurate and intuitive observation so great that he was able to perceive the natural energies and other phenomena occurring in nature, which are still unrecognized by orthodox science. Refusing to attend University at the age of 18, to the fury of his father, Viktor Schauberger left home and spent a long period alone in the high, remote forest, contemplating, pondering and observing the many subtle energetic processes taking place in Nature's laboratory, where they were still undisturbed by human hand. During this period he developed very profound and radical theories, later to be confirmed practically, concerning water, the energies inherent in it and its desired natural form of motion. These eventually earned him the name of 'The Water Wizard'. For the whole of his life he fought a running and often acrimonious battle with academia and its institutions, since his theories in the main were diametrically opposed to the so-called established facts of science. His practical demonstration of them always functioned as he had theorized, however, for he had come to understand the true inner workings of Nature and was able to emulate them.

Viktor Schauberger's theories afford new insights into the naturally correct or naturalesque management of water. This encompasses its proper handling, storage, and conduction by means that promote its self-purification, the retention and enhancement of its natural energies and health. In this book, the close interrelationship between water and the forest (as a water-producer - not a water consumer) is examined. Also addressed is the problem of soil salinity and how this comes about through over-exposure of the soil to the radiance of the sun through deforestation and faulty agricultural practices, are also addressed. Indications are given as to how these may be avoided and overcome, due to Viktor Schauberger's radical and fundamentally new understanding of the coming into being and functioning of the groundwater table in relation to soil temperature.

As a natural organism, water is formed and functions according to Nature's laws and geometry, the latter exhibiting none of the elements of the straight line, circle and point, the basis of modern mechanical and technological artifacts. Reflecting Nature's principal constant, namely that of continuous change and transformation, the vortex epitomizes this form of open, fluid and flexible motion. Through his study of the vortices occurring naturally in flowing water and in the air in the form of cyclones and tornadoes, Viktor Schauberger developed his theories of implosion. It was through the research and development of these theories that he was able to

produce spring-quality water and generate considerable energies in and with water and air.

In listing some of his accomplishments one could not do better than to quote from his book, ***"Our Senseless Toil"***, written in 1933: ***"It is possible to regulate watercourses over any given distance without embankment works; to transport timber and other materials, even when heavier than water, for example ore, stones, etc., down the centre of such water-courses; to raise the height of the water table in the surrounding countryside and to endow the water with all those elements necessary for the prevailing vegetation. Furthermore it is possible in this way to render timber and other such materials non-inflammable and rot resistant; to produce drinking and spa-water for man, beast and soil of any desired composition and performance artificially, but in the way that it occurs in Nature; to raise water in a vertical pipe without pumping devices; to produce any amount of electricity and radiant energy almost without cost; to raise soil quality and to heal cancer, tuberculosis and a variety of nervous disorders... the practical implementation of this ... would without doubt signify a complete reorientation in all areas of science and technology. By application of these new found laws, I have already constructed fairly large installations in the spheres of log-rafting and river regulation, which as is known, have functioned faultlessly for a decade, and which today still present insoluble enigmas to the various scientific disciplines concerned."***

Water and its vital interaction with the forest was Viktor's principal preoccupation. He viewed water as a living entity, the 'Blood of Mother-Earth', which is born in the womb of the forest. Our mechanistic, materialistic and extremely superficial way of looking at things, however, prevents us from considering water to be anything other than inorganic, i.e. supposedly without life but, while apparently having no life itself, can nevertheless miraculously create life in all its forms. Life is movement and is epitomized by water, which is in a constant state of motion and transformation, both externally and internally. In confirmation of this fact, water is able to combine with more substances than any other molecule and, flowing as water, sap and blood, is the creator of the myriad life-forms on this planet. How then could it ever be construed as life-less in accordance with the chemist's clinical view of water, defined as the inorganic substance H_2O ? This short description is a gross misrepresentation. As the fundamental basis of all life, water is itself a living entity and should be treated as such. Failure to do so quickly transforms it into an enemy, rather than the nurturer and furtherer of all life that it should be.

"This civilization is the work of man, who high-handedly and ignorant of the true workings of Nature, has created a world without meaning or foundation, which now threatens to destroy him, for through his behavior and his activities, he, who should be her master, has disturbed Nature's inherent unity."

Apart from the more familiar categories of water, there are, according to Viktor Schauberger, as many varieties of water as there are animals and plants. Were water merely the sterile, distilled H_2O as claimed by science, it would be poisonous to all living things. ***H_2O or 'juvenile***

water' is sterile, distilled water and devoid of any so-called 'impurities'. It has no developed character and qualities. As a young, immature, growing entity, it grasps like a baby at everything within reach. It absorbs the characteristics and properties of whatever it comes into contact with or has attracted to itself in order to grow to maturity. This "everything" - the so-called "impurities"- takes the form of trace elements, minerals, salts and even smells! Were we to drink pure H_2O constantly, it would quickly leach out all our store of minerals and trace elements, debilitating and ultimately killing us. Like a growing child, juvenile water takes and does not give. Only when mature, i.e. when suitably enriched with raw materials, is it in a position to give, to dispense itself freely and willingly, thus enabling the rest of life to develop. Before the birth of water, there was no life. But what is this marvelous, colorless, tasteless and odorless substance, which quenches our thirst like no other liquid? Did we but truly understand the essential nature of water - a living substance - we would not treat it so churlishly, but would care for it as if our lives depended on it, which undoubtedly they do.

"The Upholder of the Cycles which supports the whole of Life, is water. In every drop of water dwells the Godhead, whom we all serve; there also dwells Life, the Soul of the "First" substance - Water - whose boundaries and banks are the capillaries that guide it and in which it circulates."More energy is encapsulated in every drop of good spring water than an average-sized PowerStation is presently able to produce. " Indeed in accordance with the famous Hasenöhr-Einstein equation $E = mc^2$, in 1 gram of substance, or 1 cubic centimeter of water, 25 million kilowatt hours of energy are stored!

Water is a being that has life and death. With incorrect, ignorant handling, however, it becomes diseased, imparting this condition to all other organisms, vegetable, animal and human alike, causing their eventual physical decay and death, and in the case of human beings, their moral, mental and spiritual deterioration as well. From this it can be seen just how vital it is, that water should be handled and stored in such a way as to avert such pernicious repercussions.

"Science views the blood-building and character-influencing ur-organism" In Viktor Schauberger's writings in German, the prefix '**Ur**' is often separated from the rest of the word by a hyphen, e.g. '**Ur-sache**' in lieu of 'Ursache', when normally it would be joined. By this he intends to place a particular emphasis on the prefix, thus endowing it with a more profound meaning than the merely superficial. This prefix belongs not only to the German language, but in former times also to the English, a usage which has now lapsed. According to the Oxford English Dictionary, '**ur**' denotes 'primitive', 'original', 'earliest', giving such examples as '**ur-Shakespeare**' or '**ur-origin**'. This begins to get to the root of Viktor's use of it and the deeper significance he placed upon it. If one expands upon the interpretation given in the Oxford English Dictionary, then the concepts of 'primordial', 'primeval', 'primal', 'fundamental', 'elementary', 'of first principle', come to mind, which further encompass such meanings as: - pertaining to the first age of the world, or of anything ancient; - pertaining to or existing from the earliest beginnings;- constituting the earliest beginning or starting point;- from which something else is derived, developed or depends; applying to parts or structures in their

earliest or rudimentary stage; - the first or earliest formed in the course of growth.

To this can be added the concept of an '**ur-condition**' or '**ur-state**' of extremely high potential or potency, a latent evolutionary ripeness, which given the correct impulse can unloose all of Nature's innate creative forces. In the English text, therefore, the prefix "**ur**" will also be used wherever it occurs in the original German and the reader is asked to bear the above in mind when reading what follows. **"'Water', when looked at as merely a chemical compound that provides millions of people with a liquid is absurd; from this point of view, it is everything but healthy water."** But what does modern, de-naturalised civilization care, as long as it receives a suitably hygienised, clear liquid to shower, wash its dishes, clothes and cars. Once down the plug-hole in company with all manner of toxic chemicals and detergents, all is comfortingly out of sight and out of mind.

"Our primeval Mother Earth is an organism that no science in the world can rationalize. Everything on her that crawls and flies is dependent upon Her and all must hopelessly perish if that Earth dies that feeds us." Although the chlorination of drinking and household water-supplies ostensibly removes the threat of water-borne diseases, it does so, however, to the detriment of the consumer. In its function of water sterilizer or disinfectant, chlorine eradicates all types of bacteria, beneficial and harmful alike. More importantly, however, it also disinfects the blood (about 80% water) or sap (ditto) and in doing so kills off or seriously weakens many of the immunity-enhancing micro-organisms resident in the body of those organisms constantly forced to consume it. This eventually impairs their immune systems to such a degree that they are no longer able to eject viruses, germs and cancer cells, to which the respective host-bodies ultimately falls victim.

The appearance of AIDS, therefore, and the enormous increase in all forms of disease, cancer in particular, would have come as no surprise to Viktor Schauberger. Apart from the other inevitable disturbances to the ecology and the environment occasioned by humanity's unthinking activities, he foresaw it all as early as 1933.

"For a person who lives 100 years in the future, the present comes as no surprise."

Apart from other factors (some cannot be defined quantitatively), encompassing such aspects as turbidity (opaqueness), impurity, and quality, the most crucial factor affecting the health and energy of water is temperature. As a liquid, the behavior of water differs from all other fluids. The latter become consistently and steadily denser with cooling, water reaches its densest state at a temperature of +4° C (+39.2° F), below which it grows less dense. In contrast, water's behavior is anomalous, because it reaches its greatest density at a temperature of +4°C (+39.2°F). This is the so-called 'anomaly point', or the point of water's anomalous expansion, which is decisive in this regard and has a major influence on its **quality**. Below this temperature it once more expands. This highest state of density is synonymous with its highest energy content, a factor to be taken carefully into account, since energy can also be equated with life or life-force. Therefore if water's health, energy and life-force are to be maintained at

the highest possible level, then certain precautions must be taken, which will be addressed later.

Conceived in the cool, dark cradle of the virgin forest, water ripens and matures as it slowly mounts from the depths. On its upward way it gathers to itself trace elements and minerals. Only when it is ripe, and not before, will it emerge from the womb of the Earth as a spring. As a true spring, in contrast to a seepage spring, this has a water temperature of about $+4^{\circ}\text{C}$ ($+39.2^{\circ}\text{F}$). Here in the cool, diffused light of the forest it begins its long, life-giving cycle as a sparkling, lively, translucent stream, bubbling, gurgling, whirling and gyrating as it wends its way valley wards. In its natural, self-cooling, spiraling, convoluting motion, water is able to maintain its vital inner energies, health and purity. In this way it acts as the conveyor of all the necessary minerals, trace elements and other subtle energies to the surrounding environment. Naturally flowing water seeks to flow in darkness or in the diffused light of the forest, thus avoiding the damaging direct light of the sun. Under these conditions, even when cascading down in torrents, a stream will only rarely overflow its banks. Due to its correct natural motion, the faster it flows, the greater its carrying capacity and scouring ability and the more it deepens its bed. This is due to the formation of in-winding, longitudinal, clockwise - anti-clockwise alternating spiral vortices down the central axis of the current, which constantly cool and re-cool the water, maintaining it at a healthy temperature and leading to a faster, more laminar, spiral flow.

To protect itself from harmful effects of excess heat, water shields itself from the sun with over-hanging vegetation, for with increasing heat and light it begins to lose its vitality and health, its capacity to enliven and animate the environment through which it passes. Ultimately becoming a broad river, the water becomes more turbid, the content of small-grain sediment and silt increasing as it warms up, its flow becoming slower and more sluggish. However, even this turbidity plays an important role, because it protects the deeper water-strata from the heating effect of the sun. Being in a denser state, the colder bottom-strata retain the power to shift sediment of larger grain-size (pebbles, gravel, etc.) from the centre of the watercourse. In this way the danger of flooding is reduced to a minimum. The spiral, [vortical motion](#) mentioned earlier, which eventually led Viktor Schauberger to the formation of his theories concerning 'implosion', creates the conditions, where the germination of harmful bacteria is inhibited and the water remains disease-free.

Another of its life-giving properties is its high specific heat - lowest at $+37.5^{\circ}\text{C}$ ($+99.5^{\circ}\text{F}$). The term "specific heat" refers to the capacity and rapidity of a body to absorb or release heat. With a relatively small input of heat fluids with a high specific heat warm up less rapidly than those with a lower specific heat. How strange then, and how remarkable, that the lowest specific heat of this "inorganic" substance - water - lies but 0.5°C (0.9°F) above the normal $+37^{\circ}\text{C}$ ($+98.6^{\circ}\text{F}$) blood temperature of the most highly evolved of Nature's creatures - human beings. This property of water to resist rapid thermal change enables us, with blood composed of 80% water, to survive under large variations of temperature. Pure accident so we are told, or is it by

clever, symbiotic design ?! However, since we are used to thinking about temperature in gross terms (car engines operate at temperatures of 1,000°C (1,832°F) or so and many industrial processes employ extremely high temperatures) and despite the fact that we begin to feel unwell if our temperature rises by as little as 0.5°C (0.9°F), we fail to see that non-mechanical, organic life and health are based on very subtle differences in temperature. When our body temperature is +37°C (98.6°F) we do not have a 'temperature' as such. We are healthy and in a state that Viktor Schauberger called 'indifferent' or 'temperature-less'. Just as good water is the preserver of our proper bodily temperature, our anomaly point of greatest health and energy, so too does it preserve this planet as a habitat for our continuing existence. Water has the capacity to retain large amounts of heat and were there no water vapor in the atmosphere, this world of ours would be an icy-cold, barren wasteland. Water in all its forms and qualities is thus the mediator of all life and deserving of the highest focus of our esteem. ***"To Be or Not to Be: In Nature all life is a question of the minutest, but extremely precisely graduated differences in the particular thermal motion within every single body, which continually changes in rhythm with the processes of pulsation. This unique law, which manifests itself throughout Nature's vastness and unity and expresses itself in every creature and organism, is the 'law of ceaseless cycles' that in every organism is linked to a certain time span and a particular tempo. The slightest disturbance of this harmony can lead to the most disastrous consequences for the major life forms. In order to preserve this state of equilibrium, it is vital that the characteristic inner temperature of each of the millions of micro-organisms contained in the macro-organisms be maintained."***

The Number 1 enemy of water is excess heat or over-exposure to the sun's rays. It is a well-known fact that oxygen is present in all processes of organic growth and decay. Whether its energies are harnessed for either one or the other is to a very great extent, if not wholly, dependent on the temperature of the water as itself or in the form of blood or sap. As long as the water-temperature is below +9°C (+48.2°F), its oxygen content remains passive. Under such conditions the oxygen assists in the building up of beneficial, high-grade micro-organisms and other organic life. However, if the water temperature rises above this level, then the oxygen becomes increasingly active and aggressive. This aggressiveness increases as the temperature rises, promoting the propagation of pathogenic bacteria, which, when drunk with the water, infest the organism of the drinker. ***"Thus the development of micro-organisms and the opportunities for their propagation are simply a result of the condition in which the respective sickening macro-organism finds itself, which will be attacked by these parasites and which eventually must fall victim to them if its inner climatic conditions are no longer strictly regulated."***

But this aggressiveness is not confined to the domain of oxygen alone. When water becomes over-heated, due principally to the increasingly widespread clear-felling of the forest, the health-maintaining pattern of longitudinal vortices changes into transverse ones. These not only undermine and gouge into the riverbanks and embankment works, eventually bursting them, but also create pot-holes in the riverbed itself, bringing even greater disorder to an already

chaotic channel-profile.

According to Viktor Schauberger, water subjected to these conditions loses its character, its soul. Like humans of low character, it becomes increasingly violent and aggressive as it casts about hither and thither seeking to vent its anger and restore to itself its former health and stability. However, due to the senseless malpractice of the clear-felling of forests, we are destroying the very foundation of life. For with the removal of the forest, two very serious things happen:

1). During its flow to the sea, the water warms up prematurely to such an extent that it is warmed right down to the channel-bed. No cool, dense, water-strata remain and the sediment is left lying on the bottom. This blocks the flow, dislocates the channel and results in the inevitable, often catastrophic floods. Yet we still have the effrontery to call these awesome events 'natural disasters', as if Nature herself were responsible. Furthermore, due to the broadening of the channel, even more water is exposed to the sun's heat, resulting in over-rapid evaporation to the atmosphere. In many cases this overloads the atmosphere with water-vapor, which it is unable to retain in suspension. Deluges follow.

2). With the forest-cover now removed, the ground also begins to heat up to temperatures much higher than normal and natural. Dry soil heats up as much as five times faster than water. This has a two-fold effect:

a). The rejection and repulsion by the warmer soil of any incident rain-water, whose temperature in this case is generally lower. Cold rain will not readily infiltrate into warm soil. This results in rapid surface run-off and no groundwater recharge. The soil dries out.

b). An increase in pathogenic microbial activity, harmful to plant life.

The upshot of all this is more flooding, reduced groundwater quantity and lower groundwater table. One flood therefore begets the next in rapid succession. But since there is no groundwater recharge, the water-balance and natural distribution are completely upset. The remaining trees - the vital retainers of water - die, leaving the land barren and desiccated with the necessary sequel of drought. The less the tree-cover, the more extensive the flooding and the longer the period of drought, of **water-lessness**, which is synonymous with **life-lessness** !

Unnatural, quantity-inspired forestry practices, ignorant of Nature's laws, and the over-warming of the soil arising from massive deforestation are the primary causes of the deterioration in water quality, climate and the sinking of the water table. The channeling of water through straight, unnaturally constructed, trapezoid canals, steel pipelines and other misguided systems of river regulation also force the water to move in an unnatural way and accelerate its degeneration and increase its disease-carrying capacity.

"Wherever we look the dreadful disintegration of the bridges of life, the capillaries and the bodies they have created, is evident, which has been caused by the mechanical and mindless work of man, who has torn away the soul from the Earth's blood - water. The more the engineer endeavors to channel water, of whose spirit and nature he is today still ignorant, by the shortest and straightest route to the sea, the more the flow of water

weighs into the bends, the longer its path and the worse the water will become. The spreading of the most terrible disease of all, of cancer, is the necessary consequence of such unnatural regulatory works. These mistaken activities - our work - must legitimately lead to increasingly widespread unemployment, because our present methods of working, which have a purely mechanical basis, are already destroying not only all of wise Nature's formative processes, but first and foremost the growth of the vegetation itself, which is being destroyed even as it grows. The drying up of mountain springs, the change in the whole pattern of motion of the groundwater, and the disturbance in the blood circulation of the organism - Earth - is the direct result of modern forestry practices. The pulse-beat of the Earth was factually arrested by the modern timber production industry. Every economic death of a people is always preceded by the death of its forests. The forest is the habitat of water and as such the habitat of life processes too, whose quality declines as the organic development of the forest is disturbed. Ultimately, due to a law which functions with awesome constancy, it will slowly but surely come around to our turn. Our accustomed way of thinking in many ways, and perhaps even without exception, is opposed to the true workings of Nature. Our work is the embodiment of our will. The spiritual manifestation of this work is its effect. When such work is carried out correctly, it brings happiness, but when carried out incorrectly, it assuredly brings misery." There is only one solution! Would we live and ensure a sustainable future then we must plant trees for our very lives, but far more importantly, we have a duty to do it for those of our children.

More immediately, however, we must care for the very limited stocks of water still available. This means treating it in the way demonstrated to us by Nature. First and foremost, water should be protected from sunlight and kept in the dark, far removed from all sources of heat, light and atmospheric influences. Ideally it should be placed in opaque, porous containers, which on the one hand cut out all direct light and heat, and on the other, allow the water to breathe, which in common with all other living things, it must do in order to stay alive and healthy. In terms of what we can achieve personally, we should at all times ensure that our storage vessels, tanks, etc., are thoroughly insulated, so that the contained water is maintained at the coolest temperature possible under the prevailing conditions. The materials most suited to this are natural stone, timber (wooden barrels) and terracotta. Perhaps more than any other material, terracotta has been used for this purpose for millennia. Terracotta exhibits a porosity particularly well-suited to purposes of water storage. This is because it enables a very small percentage of the contained water to evaporate via the vessel walls. Evaporation is always associated with cooling (vaporization, however, with heat) and, according to Walter Schauberger (Viktor's physicist son), if the porosity is correct, then for every 600th part of the contents evaporated, the contents will be cooled by 1°C (1.8°F), thus approaching a temperature of +4°C (+39.2°F).

While the material for the construction of a water-storage vessel has been addressed above, another important factor is the actual shape of the container itself. Most of the storage containers commonly in use today take the form of cubes, rectangular volumes of one form or

another, or cylinders. While these are the shapes most easily and economically produced by today's technology, they do have certain drawbacks in terms of impeding natural water circulation and water suffocation. Due to their rectangular shape and/or right-angled corners, certain stagnant zones are created, conducive to the formation of pathogenic bacteria. Moreover, since the materials used are generally galvanized iron, fiber glass, concrete, etc., i. e. all impervious materials, the contained water is unable to breathe adequately and suffocates as a result. In this debilitated state or as a water-corpse, it is no longer either healthy or health-giving and may require further disinfection.

Should we now make a study of those shapes that Nature chooses to propagate and maintain life, it soon becomes apparent that the cubes and cylinders mentioned above have no place in Nature's scheme of things. Instead, eggs and elongated egg-shapes such as grains and seeds are employed, presumably because Nature in her wisdom has determined that these produce the optimal results. Historically speaking, it is evident that earlier civilizations such as the Egyptians and Greeks, renowned for their logic and constructional ability, were well aware of this, because they stored their grains and liquids (oils, wines, etc.) in terracotta amphorae, sealed with beeswax. All this despite the fact that for all rational, practical purposes, the shape was wholly unsuited to compact and efficient storage in terms of space and ease of handling. It is obvious that the selection of this form over any other was intentional and as the result of certain knowledge of the long-term storage properties of such shapes. In many amphorae that have surfaced in archaeological excavations over the last 100 years or so, grains of wheat have been found that were still viable and even after storage over 2,000 years, grew when planted. This fact alone should suffice to affirm the efficacy of the properties of vessels of such shape.

Taking Viktor Schauberger's exhortation, "**Comprehend and copy Nature!**" as our guide, we should therefore make use of the shapes that Nature herself selects to contain, guard and maintain life, i.e. eggs and their derivations. Compared with cubes and cylinders, these shapes have no stagnant zones, no right-angled corners that inhibit flowing movement. By placing our terracotta vessels in shaded areas, exposed to air movement, the evaporative cooling effect will be significantly enhanced and since all natural movement of liquids and gases is triggered by differences in temperature, so too inside the egg-shaped storage vessel, cyclical, spiral, vitalizing movement of the water will be induced.

Movement is an expression of energy and energy is synonymous with life. The external evaporation causes cooling of the outer walls and the water in their immediate vicinity. Being cooler and therefore denser, this water becomes specifically heavier and sinks down along the walls towards the bottom at the same time forcing the water there to rise up the centre and move towards the outside walls. Continual repetition of this process results in the constant circulation and cooling of the contents.

Having discussed the above ideal storage vessel and in view of the fact that they are presently

not available on the market, it would be a sorry omission, if methods of improving existing installations were not also addressed. The main factor to be taken into account here is that of exposure to light and heat. Where possible, all above-ground water tanks, whether of galvanized iron, fiber-glass or concrete, should be insulated on all sides and external surfaces through the application of sprayed foam or equivalent thermal barrier to a minimum thickness of 75mm. If not already white or of a light, heat-reflecting color, then it should be so painted. For in-ground tanks, the top surface only need be insulated and rendered white in color.

For many people dams or rivers provide the main source of water and certain simple measures can be taken to improve the quality of the water obtained from them. Providing the surrounding soil is not impervious to water, a hole of suitable dimension, depth and capacity (say 1,000 - 2,000 liters) should be dug about 5 - 10 meters from the banks of the dam or river. If possible the depth should be equal to the depth of the latter. Wells dug next to dams should be situated above the highest water level. If the consistency of the soil is permeable enough, then water will percolate through the intervening soil and into the newly excavated well. Depending on the stability and load-bearing capacity of the soil (a structural engineer should be consulted if there is any doubt), a small concrete, perimeter footing should be placed at a safe and stable distance from the rim of the well. When the concrete has cured and set firmly, then a minimum of 1 course of blocks should be laid to prevent the entry of any surface water. In the case of wells next to rivers, however, it may be necessary to raise the height of the block work to just above the average height of flood waters to prevent contamination of the well water during floods.

The well should then be totally enclosed and sealed with a well-insulated timber and sheet-metal roof, or a concrete slab, and provided with an access hatch to service the pump and/or suction pipe and foot-valve. Preferably the pump should be located outside the well-space to avoid any possible oil pollution, etc.

The reason for having the 1,000 - 2,000 liter storage capacity mentioned earlier, is that it may only be possible to pump water intermittently, because the rate of replenishment from the main water source may be fairly slow, depending on the permeability of the soil. In the event that the soil surrounding a dam or a river is impervious, then it would be necessary to excavate a channel about 600 mm wide between the well and the main water body. The lower part of this should be filled with clean, quartz sand to a depth of about 600 mm and the upper part back-filled with the excavated material and compacted. As the water percolates through either the existing soil or the emplaced sand most suspended matter will be filtered out. Also, because the water accesses the well at the lowest level, the water actually transferred from the main water source to the well will be as cool as possible under the prevailing conditions. In this state it is less likely to harbor harmful, pathogenic bacteria, which tend to populate the upper, more highly oxygenated strata of the main water body.

The adoption of such measures on the author's own property produced an extremely clear, clean, odorless and good tasting water. Despite all outward appearances, however, it is still

advisable to have such water tested for quality, purity and any possible contaminants by the responsible authorities. In terms of its mineral, salt and trace-element content, river-water would generally be far richer than tank-water (rainwater). With reference to the immature and mature water discussed at the beginning, in most cases it would be necessary to supplement the mineral content of rainwater, if this is the only source of drinking water, in order to prevent the extraction of these from the body of the drinker. Here the suspension of an artificial-fiber sack (rot-proof) containing the dust of crushed basalt or other igneous rock used for road building (commonly known as 'crusher dust') would do much to enhance the composition of the tank water, because it will hungrily absorb those elements it requires to become mature. However, before adding any crusher dust to the water, it would be again advisable to test the resulting change in the quality by analyzing the difference between two samples of tank water, one with crusher-dust added and one without as a control. Both samples should then be placed in a cool, dark place and left for at least a week before analysis of the mineral content, bacterial purity, etc. is carried out. This should be done by a suitably qualified specialist.

These suggestions for improving water quality are the result of my personal experience and understanding of Viktor Schauberger's pioneering discoveries and theories. Viktor Schauberger's great dictum, frequently asserted, was "**C² - Comprehend & Copy Nature**", for it was only thus that humanity could emerge from its present crisis-stricken condition. ***"They call me deranged. The hope is that they are right! It is of no greater or lesser import for yet another fool to wander this Earth. But if I am right and science is wrong, then may the Lord God have mercy on mankind!"***

Indeed at the Stuttgart University of Technology, West Germany in 1952 these theories were tested under strict scientific and laboratory conditions by Professor Dr. Ing. Franz Pöpel, a hydraulics specialist. These tests showed that, when water is allowed to flow in its naturally ordained manner, it actually generates certain energies, ultimately achieving a condition that could be termed 'negative friction'. Checked and double-checked, this well-documented, but largely unpublicized, pioneering discovery not only vindicated Viktor Schauberger's theories. It also over-turned the hitherto scientifically sacred 'Second Law of Thermodynamics' in which, without further or continuous input of energy, all (closed) systems must degenerate into a condition of total chaos or entropy. These experiments proved that this law, whilst it applies to all mechanical systems, does not apply wholly to living organisms.

As a result of these discoveries, it was arranged that Viktor Schauberger be taken to the United States in 1958, where sums amounting potentially to many millions of dollars could be made available as start-capital for a Los Alamos-like venture to develop Viktor Schauberger's theories of Implosion. He was accompanied by his son, Walter Schauberger, a physicist and mathematician, to assist in the scientific interpretation of his father's theories. Soon after arrival, however, various misunderstandings developed, too complex to elaborate here,

whereupon Viktor Schauberger fell silent and refused to participate. After some three months of silence the project was abandoned. Viktor and Walter Schauberger were then permitted to return to Austria, where Viktor died in Linz some five days later on the 25th September 1958, a very disillusioned man.

On their return journey, Viktor asked Walter to translate his theories of Implosion into terms of physics, geometry and mathematics, in such manner that their veracity was irrefutable. Because Viktor Schauberger's concepts broke new ground, this presented some difficulty. There was no adequate scientific terminology to describe them, nor was there any mathematical basis from which the necessary shapes could be precisely defined or constructed. With his own devices and apparatuses, Viktor Schauberger had also encountered problems of construction, which in part affected the optimum functioning of these machines, because the state and sophistication of the technology then available was inadequate and too cumbersome to build them properly and accurately.

The vital development of a new technology, harmonious and conforming to Nature's laws, demands a radical and fundamental change in our way of thinking and to our approach to the interpretation of the established doctrines and facts of physics, chemistry, agriculture, forestry and water management. As a pointer as to how such a new technology should come about, let me quote Viktor Schauberger once more:

"How else should it be done then?", was always the immediate question. The answer is simple: "Exactly in the opposite way that it is done today!"

(NOTE: All quotations in italics were taken from Viktor Schauberger's writings during the period 1930 - 1933)

The Beginnings of Genius : Viktor Schauberger (by Callum Coats)

In the district where Schauberger lived and worked, there had been no interference in the balance of Nature and Viktor was thus able to observe events that are today inconceivable, and which no longer take place (because of the enormous deterioration of the environment). It was here that he acquired the insights into the natural movement of water that resulted in the building of his first log flume. Here too he first became aware of other levitational energies found in water. One day, in the middle of a very cold winter, as he was about to cross over a fast-flowing mountain stream, he flushed a stationary trout from its lair. Startled, he sought a firm hold for his staff on the stream bed. The trout's lightning flash upstream immediately caused a number of questions to race through his mind:

"How did the trout actually manage to get to this **spot**"? Later I saw dozens of

them in the same stream; a stream which, about a kilometer **downstream**, was cut off by a 60 meter high waterfall - which atomized the water into a veil of mist. "How did it traverse the waterfall"?

"How was it able to flee **upstream** like a streak of greased lightning, in mockery of all the laws of gravity? How was it possible for this fish to *stand* so motionlessly, only steering itself with slight movements of its tail-fins, in this wildly torrential flow, which made my staff shake so much that I could hardly hang onto it?

"What forces enabled the trout to **overcome** its own body-weight so effortlessly and quickly, and, at the same time, overcome the specific weight of the heavy water flowing *against* it?

Why didn't the water **freeze** even during periods of severe frost with temperatures **below** -30° Centigrade?"

While Viktor undoubtedly had an special talent for observation, a penetrating power of perception undimmed by preconceptions, he also developed what might be called an active consciousness - an ability to go beyond the merely "visual" in search of what lay behind a given phenomenon. This taught him a great deal and this ability gradually evolved, as he explained:

"The Schauberger's' principal preoccupation was the conservation of the forest and wild game, and even in earliest youth my fondest desire was to **understand** Nature, and thus to come closer to the truth; a truth that I was unable to discover either at school or in church.

"In this quest, I was thus drawn time and time again, up into the forest. I could sit for hours on end and watch the water flowing by without ever becoming tired or bored. At the time I was still unaware that in water the greatest secret lay hidden. Nor did I know that water was the carrier of life or the **ur-source** of what we call consciousness. Without any preconceptions, I simply let my gaze fall on the water as it flowed past. It was only years later that I came to realize that running water attracts our consciousnesses like a magnet and draws a small part of it along in its wake. It is a force that can act so powerfully, that one temporarily loses consciousness, and involuntarily falls asleep. As time passed, I began to play a game with water's secret powers; I surrendered my so-called free consciousness and allowed the water to take possession of it for a while. Little by little this game became very earnest, because I realized that one could detach one's own consciousness from the body and attach it to that of the water."

"When my own consciousness was eventually returned to me, then the water's

deeply concealed psyche often revealed the most extraordinary things to me. As a result of this investigation a researcher was born, who could dispatch his consciousness on a voyage of discovery, as it were. In this way I was able to experience things that had escaped other people's notice, because they were unaware that a human being is able to send forth his free consciousness into those places the eyes cannot see."

"By practicing this blindfolded vision, I eventually developed a bond with mysterious Nature, whose essential being I then slowly learnt to perceive and understand."

Water, forests, natural energies and their generation were ever his passionate concern. In our present way of looking at things, he would probably be considered one of the world's first "greenies" (Dr. Richard St. Barbe-Baker, founder of 'The Men of the Trees' in 1922, and also Viktor's friend, being another). Viktor had tremendous foresight and an enormous capacity for writing, reputedly having composed many, many thousands of pages. At times, apparently in a trance-like state, he wrote for hours on his typewriter with no idea of what he had written until finally reading it at the end. Amongst other things, he set down all of what he saw would inevitably happen, (if we did not mend our ways and change our whole approach to the environment) both technologically and conceptually. All the various crises that are today engulfing humanity, Schauberger foresaw as long ago as 1930. When questioned on his predictions, he answered very simply, saying that, "For a person who lives 100 years in the future, the present is no surprise."

In the late 1920s as a result of the successful operation of Viktor's Steyrling log-flume, Prof . Philipp Forchheimer was asked by the Austrian Government to investigate his unusual theories. Through their collaboration, Forchheimer gradually became aware of the *truth* of Viktor's ideas, eventually insisting that Viktor put all his discoveries down on paper, for he thought these theories were not only valid, but extremely valuable. Forchheimer later confided that he was delighted to have retired, because he would now be relieved of the humiliating task of telling his students that he had been teaching them rubbish for the last forty-five years!

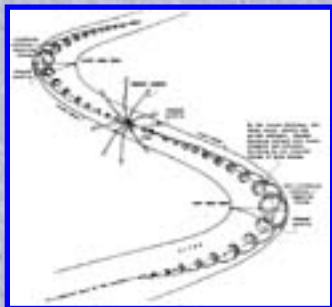

With the cooperation of Prof. Wilhelm Exner, President of the Austrian Academy of Science and inventor of the Exner electroscope, a treatise of Viktor Schauberger's, entitled "Turbulence", which described the braking function of vortices and their relation to water temperature, was placed under seal and on deposit at the Austrian Academy of Science on January 1st, 1930. This was done, not only to ensure the precedence of Viktor Schauberger's theories on water movement, but also to safeguard

them for some time in the future. While stressing its value, Forchheimer considered there to be no point in publishing it at the time, because the hydrological world was not ready. The science of hydraulics would first have to change its values and way of thinking before these trail-breaking concepts could be taken seriously. ***It wasn't until 1974 that this document was***

released to Viktor's son, Walter Schauberger..

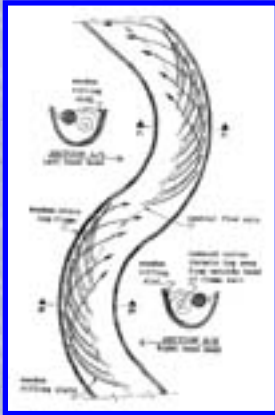

Forchheimer did change his views later, however, and saw to it that Viktor's pioneering theories on temperature and its effect on the movement of water were published in 1930-31 in a series of articles in "Die Wasserwirtschaft", the Austrian Journal of Hydrology. This showed Forchheimer to be all that a true scientist should be, and rarely is. It demonstrated the honesty and humility of a sincere academic who was prepared to accept that his former ideas had been wrong and that current thinking could be changed; that there was another way of looking at things. Pictured to the left are two of Viktor Schauberger's theories on water movement through a river channel, and it's practical application in a log flume (click for a larger view). [Viktor](#)

[Schauberger's British Patent: 415280 - Water Conduits.](#)

Viktor's aim was always to try to perceive the dynamic reality behind what he saw as physical illusion. He claimed, and rightly so, that by and large, we human beings are extremely superficial, looking for and only seeing direct relations between cause and effect, whereas *Nature* always moves indirectly. But worse than this, in our ignorance of the unseen dynamic behind the seen manifestation, we mistake the *effect* for the *cause*, greatly compounding this error by failing to see that an effect **becomes** the cause for a further effect in an endless chain of causes and effects. As Viktor comments:

"Our thinking is inconsistent with what we actually see. The eye is a perfect, natural organ. The seen image is a reaction phenomenon. Using an artificial optical apparatus, the same effect, for example, can only be obtained by a roundabout way, by means of a negative. The eye, on the other hand, immediately presents us with the diapositive, namely the true image."

"Our sight constitutes an unconscious, automatic transformation process, through which the negative image - like a photographic negative - (i.e. the effect), is transformed into a positive one, like a diapositive color slide. Our thinking, however, is really a purely individual, conscious process and therefore learnable. If our thinking is to attain the same perfection as our seeing, then we must change our way of thinking and learn to see reality, not as an action, but as a reaction. Perfect thought lies in the apprehension of the correct reaction, for before the eye can show us the positive, it must first transform the negative and in a certain manner must break up what it records. What we see therefore, is the turning inside out of what we receive. What our mind grasps in this way must be re-formed and re-thought if we wish to attain what we strive for."

Our direct mental approach towards the understanding and investigation of natural phenomena

(our present materialistic and scientifically ingrained view that only the physically palpable and measurable represents the true reality), has led to greater and greater confusion and the need to elaborate more and more complex theories to explain the various functions of the physical world. Our great omission has been our total disregard and our failure to come to grips in depth with the more ephemeral, unseen, yet fundamental energetic causalities. Like the negative mentioned in the quotation above, these energies manifest themselves only indirectly, the physical constructs of the outer physical world being a positive reflection of their respective functions. What we perceive as the foundation of physical reality - a reality to which we have ascribed laws - is therefore only half of the truth, for in their dynamic these formative magnitudes conform to a sublime inner law of energetic reciprocities:

"Nature is not served by rigid laws, but by rhythmical, reciprocal processes. Nature uses none of the preconditions of the chemist or the physicist for the purposes of evolution. Nature excludes all fire, on principle, for purposes of growth; therefore all contemporary machines are unnatural and constructed according to false premises. Nature avails herself of the biodynamic form of motion through which the biological prerequisite for the emergence of life is provided. Its purpose is to ur-procreate 'higher' conditions of matter out of the originally inferior raw materials, which afford the evolutionally older, or the numerically greater rising generation, the possibility of a constant capacity to evolve, for without any growing and increasing reserves of energy there would be no evolution or development. This results first and foremost in the collapse of the so-called Law of the Conservation of Energy, and in further consequence the Law of Gravity, and all other dogmatic lose any rational or practical basis."

In Viktor's view Western science and education generally left much to be desired. Our civilization suffered from a myopic compartmentalization of the mind, which prevented a detached overview, a synthesis of what was observed:

"Today's science thinks too primitively; indeed it could be said that its thinking is an octave too low. It has still not ventured far enough into the realm of energy, and its attitude has remained development was necessary, for how else should a misguided humanity perceive the true interdependencies?"

"Without doubt, therefore, there is a definite intention to teach young people upside-down methods of working with which they have to miss-earn their daily bread. That is to say, instead of moving forwards, they go backwards all the more rapidly in step with the improvements in the contrary methods of motion. For only thus can today's teaching principles flourish."

In contrast to contemporary science, Viktor saw *will and spirit* as the principal causative forces of physical existence. They work through the agency of various lower orders and magnitudes of energy belonging to the 4th and 5th dimensions, i.e. through those more subtle, non-spacial dimensions of being that are inherent, but are not perceived, in the three dimensional world to which we are accustomed. Of ethereal nature and endowed with very high frequencies and formative potencies, they could also be termed 'potentialities', which in their extremely sensitive and unstable state of energetic equilibrium await the right stimulus and occasion to manifest themselves. In being able to speak of these higher and therefore more powerfully and profoundly structuring dimensions of reality, Viktor's own comprehension of them must have been at the level of the 6th dimension, a level where the encapsulation and understanding of a given concept or phenomenon is both simultaneous and total. Perhaps this might be termed the dimension of 'thought' or pure truth, a crystal-clear transparency, a complete comprehension of the wholeness devoid of all uncertainty and unclarity.

From 1930-1933 Viktor Schaubberger worked with systems for water regeneration and the production of high-quality drinking water for which patents were applied in 1934. This rather cumbersome prototype was later followed by an egg-shaped device which was much smaller and far more efficient. When tested to its extreme power, however, it developed such powerful internal suction that even mercury seals (of extremely densely packed molecular structure) were unable to withstand the enormous suction generated and leaked into the water undergoing treatment. Despite the fact that this leakage occurred only when extremely high vacuum effects were present, which were absent under normal conditions of operation, the Government argued through its consultant Professor Diering that the public could not be exposed to the hazard of mercury poisoning. Laying heavy emphasis on this, all further use of the machine for the regeneration and production of spring-quality water and super-distilled water was forbidden. Indeed Viktor Schaubberger's machine had evidently offended somebody in high places, for it was confiscated and destroyed by the Austrian police.

Always a thorn in the side of scientific and government institutions, Viktor's long battle to save both the Rhine and the Danube from total ruin, was, ultimately lost through their rejection of his practical suggestions. In early 1932 he wrote a paper about the rehabilitation of the Danube detailing the measures that needed to be taken in order to reinstate it as the magnificent river it had been in days of yore. This paper was included as a separate chapter in "The Danube", a study undertaken by the International Danube Commission and consisting of submissions from the Danube's various contiguous countries.

When officialdom discovered with horror that Viktor's contribution had been incorporated into this major work, the whole edition was recalled, destroyed and republished in October 1932 omitting the offending article, disregarding the publishing costs of the original edition which amounted to over 100,000 schillings, which was a very large sum at the time. Whatever might have been thought of Viktor Schaubberger in Austria, word of his abilities and the statements contained in his new book, "Our Senseless Toil -- the Source of the World Crisis", evidently

reached others ears, including those of Adolf Hitler. At a time when the relations between Austria and Germany were at an all-time low, Viktor Schauberger was summoned to an audience with the Reichschancellor Hitler, in Berlin. Special papers were arranged and all the documentation carried out within one day. Suddenly Viktor Schauberger left for Berlin and a meeting with Hitler, who greeted him warmly as a fellow countryman, telling him that he had studied all the reports about his work thoroughly and was very impressed with what he had learned.

Thirty minutes had been allocated for the discussions, which Prof. Max Planck had been requested to attend as scientific adviser shortly before he was rudely deposed from his position as Privy Counselor. This exchange of views eventually lasted 11 hours, during which Schauberger explained the destructive action of contemporary technology and its inevitable consequences. He contrasted this with all the processes of natural motion and temperature, of the vital relation between trees, water and soil productivity, indeed all the things he considered had to be thoroughly understood and practiced in order to create a sustainable and viable society.

When Viktor had finished his explanations, Max Planck, who had remained silent, was asked his opinion about Viktor's natural theories. His response was the remarkable and revealing statement that "Science has nothing to do with Nature". Pausing for a moment to take in this astonishing admission, Viktor then referred to the proposed four-year plan, the so-called Goering Plan, stating that, not only was the time frame far too short, but, if instituted, it would gradually undermine and ultimately destroy Germany's biological foundations. As a result, the Third Reich would last only ten instead of the boasted 1,000 years. (Viktor was not far out in his estimate!)

During the earlier part of the discussion, Hitler had been enthusiastic, but he became greatly perturbed at what he had just heard and ordered his technical and economic advisers, Keppler and Wiluhn, to discuss with Schauberger what could be done. Once outside the door, these two men demanded to know how Viktor had got in there in the first place. Angered at their truculently condescending air, he replied "Through the same door I've just come out of!" Seeing that his ideas had no hope of acceptance, and leaving them gaping, he returned to his hotel and left for Austria the following morning. Keppler and Wiluhn, however, were to get their revenge later, after the Anschluss on March 13th, 1938. Despite the new order after the Anschluss and the Sword of Damocles now hanging over his head, by now hardened to setbacks and with indomitable courage and a mind never still for a moment, Viktor quietly continued his research. His main drive was to investigate phenomena and correlations that interested him. Once he had discovered that something worked, he noted the fact, and then got on with the next project. He was never very interested in commercializing what he discovered.

As ever, he pursued ways of generating energy with water through the interaction of complementary, but opposite forms of energy. Examples of this were heat and cold, suction

and pressure, electricity and magnetism, (in each case the opposites combine to create a unity) through their synthesizing, reciprocal interaction. He eventually came to realize that if a **suction effect** was ingeniously engaged **first**, and then **pressure** introduced **behind it** on the same axis, an extremely **powerful system of propulsion** could be created. According to his customary practice, in 1937-38 Viktor applied for patents for these new ideas. Once again he was the victim of deceit and his ideas were usurped, for, in a later letter to his son Walter, he wrote that copies of the preliminary application had been fraudulently obtained by **Prof. Ernst Heinkel**, the famous aircraft designer, through a firm of patent attorneys, Lehmann-Harlens in Berlin. By mining the information contained in this document, Heinkel obtained insights into how a jet-engine could be produced, even though he misinterpreted its findings; his first prototype exploded due to his lack of proper understanding. With a certain absence of principle, he then sought Viktor's collaboration in the project. Although some initial discussion eventually took place, Viktor did not cooperate, having become aware of what Heinkel had done, and further contact between the two men ceased. Using his ill-gotten gains, however, Heinkel persevered with his research, which culminated in the construction of the first successful jet-plane, its first flight being on August 27th, 1939.

Although Heinkel never had the honesty to reveal the source of the ideas for his invention, keeping all the kudos for himself, this jet plane was nevertheless built as a direct result of Viktor's theories. **Viktor Schauberger is therefore the real father of the present jet age**. He even went as far as to state that in order to develop and build fast-flying, supersonic aircraft successfully, the bodily forms of deep-sea fish should be copied. Today's 'stealth bombers' very much emulate these forms. In 1939 Viktor's personal research virtually came to an end, all the materials he needed being appropriated for war production. In 1941, however, he was summoned by Air Marshal Ernst Udet to discuss the growing crisis of energy production and means of solving it. Premises were subsequently set up near Augsburg for research and development, all of which came to nothing partly due to the death of Udet and partly because it was bombed by the Allies in 1942.

In 1943, despite his incapacitating war wounds and 58 years of age, Viktor was declared fit for active duty and was inducted into the Waffen-SS, very much under duress. He came under the control of Heinrich Himmler, who forced him into research to develop a new secret weapon. Provided with suitable accommodation at Schloss Schonbrunn, the nearby Mauthausen Concentration Camp to supply the workforce of prisoner engineers, Viktor was threatened with his life if he did not comply with orders and carry out this research.

In spite of these threats, however, Viktor put his foot down and demanded from the SS Command the absolute right to select the various engineers he needed. He further demanded that any technicians he chose were to be removed entirely from the camp, fed properly, dressed in normal civilian clothes and billeted in civilian accommodation, otherwise they would be unproductive. As he explained, people who live in fear of their lives and under great emotional stress could work neither consistently nor creatively. Surprisingly the SS agreed and

so Viktor selected somewhere between twenty and thirty engineers, craftsmen and tradesman from Mauthausen, to be accommodated in various houses near the plant.

When they were all assembled, Viktor exhorted them to work as hard as they could, but under no circumstances were they to attempt to escape, otherwise his own life would be forfeit. They set to work with a will, and, while not understanding what Viktor was trying to achieve, they nevertheless carried out his instructions faithfully. Two machines were eventually built, one called a '**Repulsator**' and the other a '**Repulsine**', reflecting their forces of recoil. Accurate information about them is difficult to obtain, because after the end of the War all top-secret information was confiscated by the Allies - the Russians, French, English and Americans - and is therefore no longer available to the general public.

Both machines operated with the densifying forces of implosion, which are far more powerful than those of explosion. This is why Viktor Schauberger was eventually taken to the United States in 1958, because the Americans obviously knew that he had been working on such prototypes, the Russians too, since they had thoroughly ransacked his apartment in Vienna after they occupied the city. Viktor Schauberger was lucky, however; due to the bombing of Vienna, he had been moved by the SS, together with his team of engineers, to Leonstein in Upper Austria. Therefore at the end of the war in May 1945 he came under the jurisdiction of the American forces of occupation.

In Leonstein Viktor was placed in protective custody for six months by the Americans and quartered inside a doubly-fenced and guarded perimeter. This was done partly to glean information about his involuntary, though to him useful wartime research at Mauthausen and Leonstein, and partly to prevent his abduction by the Russians. For Viktor however, this was a time of reflection and reassessment of his future.

During this immediately postwar period food was still extremely scarce and many people were suffering from malnutrition. When he was ultimately released, eventually moving to Salzburg in late 1946, he then set about applying his wide knowledge to agriculture and the systems of cultivation then in use. In collaboration with Franz Rosenberger, he was able to demonstrate that significant increases in productivity could be achieved using the knowledge he had acquired in Bulgaria before the war. All progress in this area subsequently being blocked by corrupt politicians in 1949, Viktor then returned to his study of implosion, energy generation, and water movement, trying with his limited funds to pick up the threads of his earlier research, culminating in a scientific investigation and vindication of his theories on the natural flow of water at Stuttgart Technical University in 1952 under the direction of Prof. Franz Popel.

With enquiring mind and tenacity of purpose, Viktor continued to work on his various devices. Aloys Kokaly, the publisher of Implosion, a magazine devoted to Viktor Schauberger's theories, and a former corporal in the Waffen-SS who had managed by devious means to procure materials for Viktor's research at Schloss Schonbrunn, asked him why he was still working so

hard, to which Viktor replied:

"I must furnish those who would protect or save life, with an energy source, which produces energy so cheaply that nuclear fission will not only be uneconomical, but ridiculous. This is the task I have set myself in what little life I have left."

The product of this last personal effort is the [home-power generator](#), which, due to Viktor's very limited pensioner's funds and its resulting crude, unsophisticated construction, did not function as well as he had hoped, for as it transpired, this machine was an unfortunate compromise between the geometry of mechanics and that of organics. It was a miserable culmination to the life's work of this quite remarkable man.

His overriding desire was to provide present and future generations with the ability in terms of knowledge and machines with which to usher in and sustain a golden age of prosperity, peace and harmony. His chief problem was always to find honest and unselfish people to help in the development and production of the various apparatuses needed to bring this about. In many instances his trust was sadly misplaced, as illustrated in extracts from a letter of the 4th February 1958 to a friend, a certain Mr. "R", about 7 months before Viktor died. He had had no appreciation or support from the government or anyone else in Austria. So when he was eventually approached by Americans who expressed an enthusiastic interest in developing his theories on implosion, Viktor felt that at last something positive would happen; for America was such a powerful country with tremendous entrepreneurial energy. He was by this time quite exasperated at the behavior of Europeans and what he had suffered at their hands, and in a conversation with Aloys Kokaly, Viktor, somewhat embittered, declared:

"An American aircraft consortium offered me 3.5 million dollars; a similar offer was made by Canadian interests. You didn't want it in Europe, so now you'll have to get it back from America expensively!" This all came to pass, but as we shall see, nothing ever came back to Europe, nor to the rest of the world for that matter. ***This has been the greatest loss and misfortune for humanity at large.***

Now for some real "fun"! As on my Nikola Tesla pages, I simply can not resist the opportunity to start everyone thinking deeper on each of these subjects...and, quite honestly, our very lives, and the life of Planet Earth could depend on all of us taking up "new" and better practices, when it comes to how we treat our environment, our bodies, agriculture...and WATER. Yes...plain ol' common **WATER**.

Did this page get you thinking? We've got a long way to go...review the books and links to products pertaining to Viktor Schauberger...and continue by clicking on the "PAGE TWO" link.

The links to the books are duplicated on all of the Viktor Schauberger pages...you will always be able to navigate to them easily. As a "**bonus**", on 'PAGE FOUR, I've included links to products that utilize the Schauberger theories and principles. There are a number on companies that are striving to replicate the work started by Schauberger, and these links represent what I believe, are the best out there. Take some time to visit their websites and review their products. Enough said... **On page two, we will more deeply explore the subject of "WATER". If you wish to join the Viktor Schauberger Yahoo Group, use the link, below. Let's go...**

Subscribe to viktorschaubergergroup

Powered by groups.yahoo.com

Click Here,

[Viktor Schauberger - Page TWO - "Living Energies", and the Power Of Water](#)

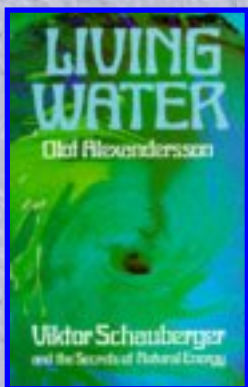

The original translation of Viktor Schauberger's work, "[Living Water](#)", by Olof Alexandersson...start here, and get each one in order. This is an excellent, brief introduction to the thought of Viktor Schauberger, and I hope it inspires works which are more complete. Callum Coates' books reach in this direction, but what is really needed are more people to read these books, synthesize their information, and come up with new and original books which take us further into depth in these areas.

This will probably involve synthesizing the work of Schauberger, Grander, Bienveniste, and others. An understanding of Schauberger is very important for those attempting to reconstruct an Indigenous European Perspective. Schauberger has the elements of a modern water shaman, and his shamanic / intuitive techniques of letting his body float with the water should be closely correlated with what Hans Peter Duerr has to say about "out of body" experience in his tome "Dreamtime". Although Schauberger lived in the 20th Century, his perspective allows us to imagine back what earlier indigenous practitioners may have been like. The Colonial, Imperialist Europe is only one side of the coin of Europe. We must also include the suppressed indigenous, pagan, and green sides. Significantly, the Inquisition represents a watershed in European history where a great deal of the indigenous healers and theorists were wiped out in holocaust proportions. An understanding of Schauberger, coupled with an appreciation of Steiner, Hildegard of Bingen, Hans Peter Duerr, and others, will allow

us to reconstruct what a noncolonial, nonimperialist Europe was like. Understanding water's nature is essential in this regard, for water forms the basis of our understandings of flow. Furthermore, understanding water's energetic qualities will help us understand how it interacts with the body. Traditional Chinese Medicine, for example, would benefit from an accurate and holistic understanding of water's qualities. In short, this book is an excellent appetizer.

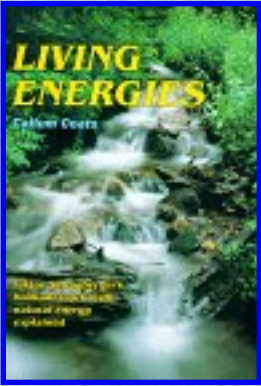

The book that started it all...[Living Energies](#),

Callum Coats first Viktor Schauberger book. If you only buy one book, this would be the one to get. Fantastic. Living Energies, May 23, 2001

Reviewer: Frank D Germano, from Tafton, PA United States: This book started it all! Callum Coats basically brought to "light" the resurgence of interest in Viktor Schauberger's theories. This is truly a brilliant work. Water as a carrier of vital energy information, trees as bio-condensers of energy

between the deep earth and the sun, how self-cleansing rivers nourish the landscape, how the future of the earth depends on the replanting of natural forests, revolutionary agricultural implements, free energy heater-coolers, jet engines and gravity defying machines invented by Schauberger in the 30's and 40's, home power generators...it's pretty much all here. It was a hard book for me to put down once I started reading, and I go back to it continually for reference. This book pretty much sums up Schauberger's work, which Coats then compartmentalized and expanded in the "Eco-Technology" series with four other books. I would highly advise getting this book, first, and reading it thoroughly, before moving on to the series, as it is a fascinating preface into discovering who Viktor Schauberger WAS, and learning just how far-reaching his theories were, and applicable to us, today. FDG.



1,) The first book of the "Eco-Technology

series" - [The Water Wizard](#) - This book gives a lot of history on Schauberger. The nature of water, May 23, 2001

Reviewer: Frank D Germano, from Tafton, PA United States: This is the first book of the "Eco-Technology" series, and as so, gives you the foundation of the theories presented by Viktor Schauberger, and amplified by Callum Coats. It DOES contain quite alot of previous information written in Living Energies

(Coat's first Schauberger book), however, the discussion and the text is much more thoroughly covered. The substance of water, water supply, deep-sea water, the consequences of drinking purely mechanically treated water, notes on the secrets of water, high-frequency water, the pulsation and healing power of water, river regulation, groundwater tables, temperature and movement of water...notice my use of the word WATER. Yes, this book is about water, but, by reading it, just wait until you discover what you DID NOT know about "water". It is a very good start, and as I said, a foundation for understanding the theories of Viktor Schauberger. FDG.

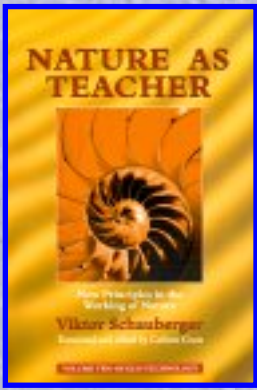

2.) Part two of the "Eco-Technology series"

[Nature As Teacher](#), A great book on living with nature. A very nice read.

Our Senseless Toil, May 23, 2001: Reviewer: Frank D Germano, from Tafton, PA United States: I had to use a title from one of the books' opening chapters. This book is going to annoy some people. Callum Coats presents Viktor Schauberg's theories in a modern light. The laws of Nature, Questions for Science, Nature as Teacher, the fish-eagle, the swing, the trout, the ox,

dancing logs and stones, the Genesis of water, the coming bio-technical age, the secret of the egg form...these are elucidated...then comes the fun stuff... the age-old secret of the atom, implosive breathing, life-force and animated breathing, is there perpetual motion (?), organic syntheses, the false world view, the mechanical equivalent of heat, plasmolytic motion; this volume gives tremendous insight into what is happening in the world, today, and practical solutions on HOW we may yet save our world. Most telling is Schauberg's inane gut feelings on the powers at work in the environment, and living water. Hey, it's only volume two of the series. Get all four, and see how these books will influence YOU to change the way we look at the earth . FDG

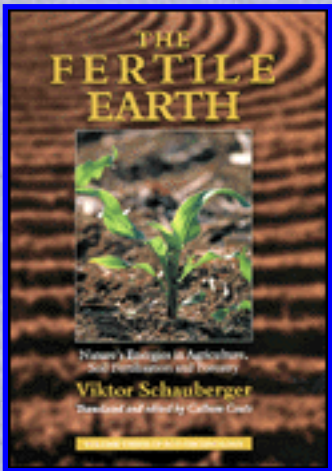

3.) [The Fertile Earth](#) , part three of the

"Eco-Technology series. Pure drinking water, how to make it, the benefits produced in the body...the natural flow and paths of rivers, and how man has disturbed nature...organic, natural farming...trees as the life giving force on the earth...it's all hear! Are you trying to save Mother Earth?, May 23, 2001

Reviewer: Frank D Germano, from Tafton, PA United States: If you are in any way interested in the environment, then this book will appeal to you.

This is the third book in the highly acclaimed "Eco-Technology" series by Callum Coats. Not only does the book delve into what man is doing to harm the environment, it also offers "fresh" ideas on what we can and should DO about it. I can't believe "Green Peace" or some other pro-environmental group doesn't have this book as part of their by-laws! Fascinating. Of coarse, the entire book is based on the revolutionary work of Viktor Schauberg. This one, if you are into farming, just have a back-yard garden, or are a hard core pro-earth person, will keep you reading till the end...and want to read the entire series. A very well written and inspiring book. A different view of natural phenomena, the influence of temperature and water movement, forestry, agriculture, the energy industry, the dying forest, timber and water in the building industry, soil fertilization, increased productivity...wow! Again, whether you are just into learning what's happening to the earth, and why, or you are serious about trying to DO something to stop the damage already done, this book will open your eyes. FDG

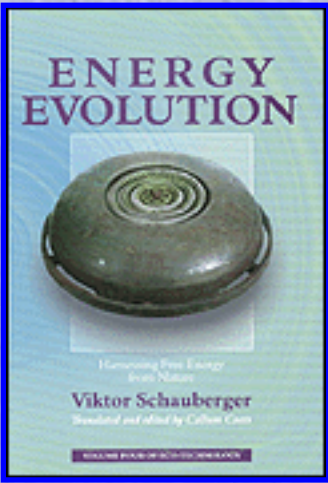

4.) [The Energy Evolution](#) , the final book

of the "Eco-Technology series" (If you are interested in the designs and patents on Schauburger's devices, this is the book. Culmination of the Eco-Technology Series, May 23, 2001

Reviewer: Frank D Germano, from Tafton, PA United States: This book, being the fourth and last of the Eco-Technology series, is an incredible finish. Naturally, all of the book deals with Viktor Schauburger, and his theories on living water, and the environment. This book, however, goes deeper into the actual inventions than the previous ones. It contains

almost all of Schauburger's patent information, most of which, even though "lost" originally, is now amplified and explained by Callum Coats. The Trout Motor, the Repulsine, and the rest of Viktor's inventions fall in place like a well stacked deck of cards. You could very easily build these wonderful engines, yourself (with some help from a good machine shop, of coarse!). If you have waited for the conclusion of the series, your wait will be well worth the time. I highly suggest you pick up this copy. FDG

This is one of the "newest" books out - Hidden Nature - by Alick Bartholomew, and it is quite simply, fantastic - highly recommended!



Sacred Living Geometry:

The Enlightened Environmental Theories of Viktor Schauburger: Our Price: \$39.95

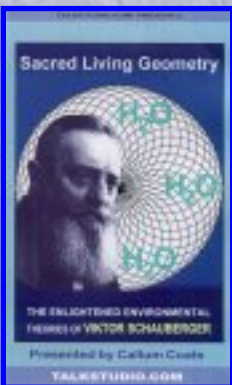

Editorial Reviews: The research of Callum Coats takes us on a journey through the life and inventions of Austrian ecologist Viktor Schauburger (1885-1958).

Now, for the first time, you can view the evidence in this detailed, three-hour illustrated lecture presentation on this two video set. Viktor Schauburger was a genius whose ideas were far

ahead of his time. He worked as a "forest-master" in the Austrian Alps when they were still a true wilderness. This experience was to influence his entire life's work. Schauberger prophesied the environmental crises we are seeing today, predicting that unless we start to cherish rather than exploit our world, we would surely destroy ourselves. He demonstrated how deforestation would deplete the world of water, causing deserts and climatic chaos. Asked about our technology, "How else should it be done?" His answer was "exactly in the opposite way that it is done today!" His maxim: "Comprehend and Copy Nature!" From his precise observations of the processes of Nature, Schauberger pioneered a completely new understanding of the nature of water as the most important life-giving and energy-empowered substance on the planet. This led him to develop a radical new science which flew in the face of conventional scientific thinking but which, today, is being increasingly recognized for its highly-relevant implications for civilization. Viktor Schauberger might have made a career as a brilliant inventor. Forced, for a time, to develop radical new forms of propulsion for the Third Reich, he went on to work on devices utilizing the principles of implosion - hundreds of times more powerful than conventional power sources. Even in the weeks just before his death, US government and commercial interests were exerting pressure on him to reveal his secrets. Schauberger's deep insights in the special properties of water and nature hold immense implications for future technology and ecology. On VHS tape, two tapes.



[BACK TO INDEX](#)

Two Products That I Will Endorse: From FutureTech Today



FutureTech Today introduces the Electron 3 & 4 Living Water Machine. This machine is being marketed through Future Tech Today, made by "For Health Reasons" of Chicago Illinois, USA. (makers* of quite probably the best water filtration system, based on victor Schaubberger's ideas, of coarse, on the planet! Purer Distilled Drinking Water:

When vapor turns to rain, it passes through temperature gradients where the temperature is continually changing with oxygen. This process stretches and contracts the H bonds that hold the molecules together...this creates ENERGY! Plant diseases are caused by viruses and bacteria, and our method of autoclaving them, using INTENSE HEAT, DESTROYS THEM (NOT just boiling).

The research chemist and others spent thousands of dollars on every product on the market, and ONLY OUR METHOD prevented the diseases in plants and caused incredible growth by just dropping plant buds in the water. Root growth 2 1/2 inches long compared to 1/8 of an inch in any of the others during the same time frame...even compared to water with nutrients added to the it!! This test was REPEATED over a period of three YEARS ...so there is no mistake!. The BOTTOM LINE is that today's ordinary water is DEAD! Why would ANYBODY want to use DEAD water, and yet most people do! If you can afford the rather steep price of their units, it is well (no pun intended!) worth the price, from personal use, on my end.

*The company that originally produced this unit is listed below - "For Health Reasons" of Chicago, IL. The company SELLING (marketing) the unit is FutureTech Today... "Future Tech Today was founded in 1998 with ambitions to break the latest energetic healing technologies to the general public while maintaining a research and development program allowing them to bring tomorrow's technology today. The idea was to represent the latest technological research in the fields of energetic medicine, water vitality, and EMF (electro-magnetic field) protection products. They represent products and technologies from all over the world, many of which are in very early stages of production or still in research phases; in this way they give the general public a preview of technologies to come..." (from their website, and used here for endorsement sake) FDG

water-revitalizer.com

ozonedetox.com

rife.biz



FutureTech Today introduces the Wellness Filter! This is the **Wellness Filter®**, and comes in various sizes to suit individual needs. In my humble opinion - it's the best on the market, today. Pricy, but well worth it. Again, this product is offered through FutureTech, Today. For website info, use either their link - FutureTech Today - or <http://www.wellness.com.au> (If you go to wellness.com.au directly, you can even become an associate, an affiliate, or a partner-type program with them if you meet their strict company requirements).

"The Wellness Filter® offers you and your family a quality of water that Nature has provided to only a select few. By using natural purification processes in combination with advanced technology, the Wellness Filter® produces what many believe is the best drinking water on Earth. The Wellness Filter®

not only removes harmful contaminants but it also enhances the water through a patented process that creates a quality of water beyond the reach of conventional water filters. Clean water plays a vital role in your health, fitness and appearance..." (from the FutureTech Today website).

A third product that I will also endorse from Ms. Nora Kosztalonyi's website:

INFINITY WATER - Infinity Water® is a Perfect Living Water based on the most advanced scientific understandings of vibration and energy as the foundation of living chemistry, where as the mainstream medical model is still caught up in the mechanistic limitations of Newtonian Physics. In 21st Century of advancements in physics and quantum mechanics it is clear that the status quo maintained by the drug companies and mainstream medical doctors is totally out of date. Based on the pioneering work of the late Viktor Schauburger...the first words out of my "significant other's" mouth was - "snake oil" - until she saw the clear effect on my blood work from the most recent Doctor/Hospital visit. Check out the website for yourself. At the very least, if you are curious, try it...if you have a positive experience as I have, let me know via email and I will attempt to push this Infinity Water even more through this website. FDG.

Learn more about Viktor Schauburger...

[purchase the books by Callum Coats, from Amazon.com](#)

HOME

NIKOLA TESLA:

[\[Home\]](#)[\[Tesla Technology, Today\]](#)[\[Nikola Tesla\]](#)[\[Nikola Tesla - Quotes\]](#)

[\[The Tesla Engine\]](#)[\[Tesla Tunguska; Free Energy\]](#)

[\[The Tesla Bladeless Boundary Disk Turbine\]](#)[\[Nikola Tesla's Radiant Energy System\]](#)

[\[Tesla's "Black Box"\]](#)[\[Greatest Hack of All Time?\]](#)

[\[the Lost Tesla Inventions\]](#)[\[A Machine To End War\]](#)

[\[the Wonderworld to be Created by Electricity\]](#)

[\[the Telsa & Schauburger Bookstore \]](#)

VIKTOR SCHAUBERGER:

[\[Water Power - Vortex Theories-\]](#)[\[Water Power II\]](#)

[\[Viktor Schauburger -1-\]](#)[\[Viktor Schauburger -2-\]](#)[\[Viktor Schauburger -3-\]](#)[\[Viktor Schauburger -4-\]](#)

[\[Christian Links\]](#)



Viktor Schauberger

Water: The Magic source of Life

The Power Of Water: by Jeane Manning

Schauberger, The Amazing "Water Wizard" (compliments: Callum Coats)

[[PAGE ONE](#)] [[PAGE TWO](#)] [[PAGE THREE](#)] [[PAGE FOUR](#)] [[Implosion Technology](#)] [[Vortex Science](#)]

[[HELP FRANK GERMANO !](#)]



The Schauberger Companion Callum Coats New \$21.95!		Living water Olof Alexandersson...		Living Energies Callum Coats New \$17.79!
 Energy Evolution Viktor Schauberger... New \$13.57!		The Fertile Earth Viktor Schauberger... New \$13.57!		Nature As Teacher Viktor Schauberger... New \$12.21!
 Living Energies Callum Coats New \$19.95!		Land der Traumer Rene Freund Used \$9.00!		Hidden Nature Alick Bartholomew New \$35.00! Used \$23.00!

(Prices May Change) [Privacy Information](#)

Water is a mysterious substance, yet we take it for granted. It is the most misunderstood and most abused element on Earth. Its chemical formula is H₂O but that isn't all there is to it. Water is alive. It is the lifeblood of the Earth. Water has its own living energy, and if water dies, our Earth dies with it. Water makes up 60 to 70% of our bodies. Minerals, proteins, sugars, and other substances dissolve in this water forming colloids, which carry a subtle electrical charge. Thus, water provides the electrical life force in all living things. Even dispersed into a fine mist, water continues to carry this vital life force, maintaining its potency and power. It is literally good to the last drop. Since water is alive, it continuously needs to regenerate itself by dewing in a spiral or vortex motion which we see in the shape of a tornado's funnel.

Water is the most potent in its densest state at a temperature of 4 degrees Celsius. Above or below this magic temperature, water loses its maximum strength and absorbent ability. In its most potent form in forests or mountain streams, water is near 4 degrees Celsius, but, as it heats up, it becomes stagnant and powerless. To be alive, water must be allowed, first, the freedom to flow in its characteristic spiral motion, and second, the freedom to approach its optimal cool temperature, of 4 degrees Celsius. The primary need of water to roll in a 3-dimensional vortex causes rivers to meander in a gentle to-and-fro motion. The water naturally swings to one bank of a river, turns, and moves across to the opposite bank, and then swings around again in a dancing rhythm of constant motion. Within every flowing stream, water constantly circles in small vortices called *eddies*. Water desires to coil itself up and spin around an invisible internal shaft like a speeding wheel. The same movement is seen in the waves of the ocean, constantly rolling in spiral movements.

This rolling motion causes water to gather electrical force. As water moves across the Earth, it cools itself and increases its internal power. Water stores this potential energy within itself and then gives the energy freely to all-living things. Through this perpetual motion, water constantly exposes its "skin" to the air. Thus it constantly spins around upon itself like a whirling top.

Just like a spinster spinning her thread, Mother Nature attempts to twist water into a thread of life, which then becomes a sparkling strand of living electricity. We see this electricity as glimmering threads of light in swift mountain streams, especially on cold moonlit nights. Victor Schauberger an Austrian forester and expert on water, demonstrated how running water has the capacity to excite and illuminate light bulbs using this principle inherent in water.

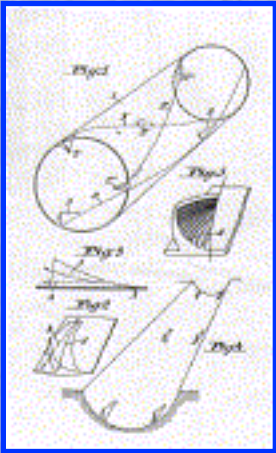

The centripetal, inward-directed movement of water causes it to become rejuvenated and creates the sucking action evident in a whirlpool. As the water accelerates more toward the center of the vortex, the electrical potential increases to very high levels. This concentrated power within water can become the power of future technology -- the vortex power of water.

The greatest damage that can be done to water is to straighten out its natural meandering. An example is the Rhine River, which was straightened, causing it to flow faster. Erosion resulted. Moreover, the eroded soil became toxic wherever it was deposited and thus could not be used for crop growth. When rivers are 'straightened', the water tends to die. The Danube River was "regulated" and forced to flow along man made channels causing the water to lose its ability to sustain life. In addition, the river level steadily dropped.

A more common way that we destroy water is by pumping it through straight pipes into our homes and offices. When healthy spring water is pumped by conventional centrifugal pumps under pressure, it rapidly loses its energy and electrical potential. It then becomes the breeding

ground for microorganisms and bacteria which must be eradicated with toxic chemicals such as chlorine and fluorine. Unfortunately, the unwary American consumes this chemically treated, dead water. Furthermore, American farmers constantly pour tons of devitalized water onto their crops, stunting growth and vitality.

(Schauberger's design for a WOOD pipe, left, with vanes (Fig.5) attached inside of the pipe, to induce a vortex producing spiral motion.)

Human arrogance causes us to try to conquer Mother Nature rather than to learn from her. Luckily we can learn from her. We can regenerate water by swirling and coiling it in its characteristic spiral motion. It then undergoes a diamagnetic energy transformation and regains its electricity, its good taste, and its life-giving power.

When water is brought to fields in canals and pipes that allow the water to flow in a natural meandering spiral fashion, crop yields have increased by 30 to 40%. Water thus delivered using the principle of vortex flow has turned salty marshes and sour swamps into productive sweet soils. If we do not make use of this knowledge, pollution will destroy water. Many aquifers and ground waters in America are now polluted. If we destroy water, we destroy ourselves. We must care for water and keep it alive simply because it is nonrenewable. No life can exist on Earth without clean, healthy water. Therefore it is absolutely essential to keep water alive. Yet our current technology is almost exclusively built on the principle of exploding centrifugal forces which lead towards the destruction of Nature and eventually the death of Earth. The combustion engine in every car, bus, and truck is a perfect example of this principle. This engine is only one side of Nature's law of motion. **(article originally published by Jeane Manning - compliments)**

The living water:

The other side is the up-building force contained in the principle of [implosion](#); the centripetal, inward-directed movement which constantly renews life and supports growth. Living water is a constant rolling exchange of gravity and levity. The waves move rapidly, and yet the water remains relatively still. In this paradox is the magic of water and the life that it gives. It is this magic in water that causes its own natural purification. In Stockholm, there is a beautiful example of this process. Sewage treatment plants are located in a park where people walk, play and have picnics. Nature's biological systems are at work treating the water. Microorganisms break down the organic matter which remains after the solid, non-biodegradable materials have been removed. A similar process is to be used to treat the terribly polluted water of Providence, Rhode Island. As a result, 99 to 100% of the toxins are removed. Microorganisms in the roots of reeds in the water break down the organic matter. Sludge is aerated, and over 90% of the solids are reduced. The plants even eliminate some heavy metals by retaining these metals in the reed stalks. Vortex technology can be used to rebuild America's agriculture. The same destructive power of water that is demonstrated in

tornadoes and hurricanes can now be harnessed for the service of all humanity. The power inherent in the cyclonic movement of water can become the source of unlimited power in our future technology.

We need to listen to the lesson Mother Nature shows us. If we learn from the natural movement of water, we will be able to save our ailing Earth. In water we can see not only the illness but also the cure if we are willing to learn the lessons Nature offers. The spiral vortex is reflected in every movement of the universe, from the shape of the galaxies, down through storm cloud formations, to the swirl of the human ear, the pumping of the heart, and the tremendous power in atomic and subatomic matter. The science of tomorrow will be based on the principle of life - the principle of implosion and the geometry of the vortex. If we are willing to learn Mother Nature's lesson, water will again be honored as the magic source of life.

The air, the water, and the earth is going to be wasted. The damages can be seen everywhere. Contamination, poisoning, and plundering of the earth's raw-materials, all break down the life-processes and destroy the energy sources. Our forest's are dying. The food that we are eating is being destroyed. The quality of our lives is decreasing. This we can see daily. This is a fact well known to everyone, even to those who are "vampiring" nature and to the scientists who are "thinking one octave to low" regarding natures' way of functioning and do not see the large energy-crises that is emerging.

Living Energies, Biotechnique in practice for the first time:

By Viktor Schauberger (from "Implosion" magazine) and compliments: Callum Coats

The family coat of arms for the von der Schauenburg family was a broken trunk with a savage hedge rose wreathing around. The family motto was: "Findus in silvis sientibus" (Faithful to the silent forests). Their castle once stood on Schauenberg. The last descendants of one of the last robber barons was caught in an ambush by the archbishop of Passau. The elder one was decapitated but the youngest was reprieved and exiled. Being the last of his family, he went into the vast primeval forests around Dreisselberg and settled down on the shore of Plöckensteinsee. Here he lived a life as a forester. From him the family Schauberger emerges, who during nearly one millennium have been foresters, fishermen and woodsmen. They had their faith in the church doctrines, as they served the crosier for a millennium, and even less, had science as their belief. They only trusted in what they saw with their own eyes and felt with their born intuition. Most of all, they knew the healing forces of water and understood how to use peculiarly shaped water-channels, which only worked during the cold night, in order to create a greater harvest than their neighbors. However, their main interests was to care for the forest and its wildlife. Many times, flooding uncovered the strange water-constructions that they built in the mountain creeks for the purpose of floating timber. These constructions forced

the water to bend in peculiarly shaped curves, in spiral looking or "snake" shaped movements. Of course, the term "cycloid space-curve movements" was unknown to them, but strange enough, they used the essence of this term so skilled, that the shaping made the channels work rhythmically so the water and the logs got a tremendous "schwung" so it sometimes passed upwards, as to making fun of the law of gravity...

"From my early childhood, it was my highest wish to be a forester, as my father, grandfather, and in fact, all my ancestors had been. When I was received by an elder forester as an assistant in his domain, my dreams came true in a way that I had not been able to paint in my dreams. Replacing the elder forester, I got my own hunting domain after the WW I. It was the most distant, but therefore, also the best, regarding hunting. As my nearest manager treated me in a patronizing way, our relation was not the best, but instead, the landlord's (Fürst Von Schunburg-Lipped) confidence for me hastily increased. When he got married, shortly after, I won one more favorer - his bride - the extremely beautiful young Princess, as I, on her birthday, managed it so that she was able to shoot a mighty twelve spine stag. In the hunting-grounds, the Princess confided that her husband was close to losing his estates, because of the changes that the War had brought. He had lost a lot of his prosperity and could only keep his estates if his economy could increase. Before this, I had already brought a plan to the estate management that would have saved the costs of the timber transports by 90 %. But this plan was rejected as unrealistic. The management said that according to Archimedes's law, timber from oak and beech could not be floated as it is heavier than water."

"However, the princess came from an open-minded family and did know of my plan. She had a feeling that this plan could save the large domain. She had also learned about the attempt to bribe me, for the purpose of making me not realize my plan. The bribe had come from the company that bought the timber "on root" from the Prince. Suddenly she asked me: "how much did they offer you"? I answered: " three times my annually wages". She abruptly stopped and asked again: "How much could be saved if your construction would be realized"? "Today the transport cost of one cubic meter of timber is 12 Schilling. We fell 30,000 cubic meters per year. This will be about 360,000 Schilling. How much would one cubic meter cost with your construction?" I answered, "1 Schilling, plus the pay off." In his domain, the prince had to make a yearly investment of 80,000 Schillings, and soon she had counted how much could be saved. "OK", she said, "lets do it". I asked for complete freedom in my work and overtook the full responsibility, and the princess kept her promises. At this time I had no idea of the risk I took. But, I was lucky, even in the most critical moments. During one of these moments I was able to make an observation whose enormous impact I realized many years after."

"The construction was completed in 4 months. The huge timber logs laid ready on the store place. One day, I did a simple test. One medium heavy log was placed in the entrance of the channel. It floated about 100 meters and laid "dead" on the bottom. The after-coming water flooded over. Immediately I saw all scornful and malicious faces in the front of me. I realized the full consequences of my failure and was furious. I removed the log from the channel. The diagnoses was clear: not enough of water and too much fall. I had no idea of what to do. At

first, I sent away my working staff to be able to think in peace."

"The shaping of the curves was all-right; no doubt about that. But, why did the construction not work, as I had thought? (*Timber flotation installation in Neuberg an der Mürz/Styria, right*) I walked along the channel slowly and finally I came down to the gathering and sorting dam which formed the entrance to a new channel. The dam was full of water. I sat down on a rock and overlooked the water surface. Suddenly, I felt a movement under my leather-trousers. I stepped back and saw a snake that had been laying there when I sat down. I threw it in the dam where it immediately swam to the shore and tried to get up. But the rock wall was steep, and the snake searched for a better place to land. When the snake crossed the dam, I looked at it. Then a thought crossed my mind: how is it possible for the snake to swim so fast without any fins? Quickly, I got my binoculars and observed the snake's strange winding movements in the crystal clear water. The snake reached the opposite shore and landed. I stood petrified for a while when I repeated every change in the snakes movement under the water. It was a combination of vertical and horizontal curves. The process of the movements struck my mind like a bolt of lightning!"



"One hour later, I was by my men in their lodge, where they were cooking dinner. Resolute, I gave my orders: "Get ready at once. Three men go to the saw mill and request a truck from the management and then bring 300 roof battens made of larch to the entrance of the channel!" The men looked strangely at me. A foreman from Tyrolean asked me: "what will you use these for"? I cut him off with: "do as you are told !" I took the master of construction with me to the entrance of the channel. I said to him: "You will get double paid if you, if necessary, work all through the night nailing these roof battens to the channel as I show you!" The master shrugged his shoulders and nodded in consent. After a couple of hours, the truck with the roof battens arrived. All night the beating of the hammers sounded. Carefully I monitored the opposite curves that the roof battens should form in the channel in order to force the water into a movement like the one that the snake had done."

"Arriving at my home at midnight, I found a letter from the Super Forest Officer telling me, that next day, around 10 o'clock, the Prince and his Princess, along with some experts and branch people, would be present to overlook the first test. While calculating, I slowly laid the letter aside. The men could be ready about 8 or 9 in the morning, if they worked all night with all their powers. I took my alp-stick and my rifle, and, after one hour I arrived at the working place. Far away, I heard the beating sound of hammers and saw the light from the truck. "When will you be ready?" I shouted. The master of construction guessed around 9 in the morning. I promised everybody three times their wages if they could be ready by 8:00 AM. They made it by half past 7. I said to the men: "Take your breakfast and be at the entrance at half past 9". There we have one more hour of work to complete, and then you will have one day of resting, double paid! The master told me to take a break before I fell down. But, I rejected him with a gesture and went to the entrance. There I waited until my men came back, and, shortly after, the

Prince, his Princess, some of my worst opponents, and the experts and branch people arrived. I saluted the Prince and his Princess and the Super Forest Officer; the rest I ignored. The princess looked worried for me. Leaning against a pole, stood the old Transport Master wearing a patronizing smile on his lips."

"I told the men to open the flood gate. Behind the gate, my men put smaller logs into the water. But when they tried to hide away one heavy, 1 yard thick log, the old transport master suddenly said: "well, well that heavy log should be in it too"! I waved at the men, and, slowly the heavy log came closer to the entrance. The log flooded the flume and the water slowly rose; no one said a word. Everybody stood and stared at the log which rose along with the water. In the next moment, the channel would have been over flooded. Then, a gurgling sound was heard and the heavy log first turned to the right and then a little to the left. After this, it wound as a snake with its front part high above the water, and then it darted away on top of the water."

"Everyone stood staring in amazement after the log had gone. Finally, the old channel master spit into the channel and caught with a hooked index finger his old quid out from his toothless mouth and through it into the channel. He muttered: "kiss my ass, it really worked"! The Prince, who did not hear what he said, wondered what he did say. I stammered something to the Prince that he had cited something from Götz von Berlichingen."

" "Well, then it is working", the Master Forester Officer said. I shortly said good-bye and disappeared into the wood with my alp-stick and my rifle. As soon as I was out of sight I sat down on a stone and dried my cold sweat from my forehead. Once, but never again, I thought. If I had not seen that snake, my life would have been gone."

"After a couple of days, I was appointed as the Master of the whole forest and hunting domain. Later on, they where coming from all over the world; experts, branch people, and also, ministers. Shortly after, I was noticed by the agriculture department in Wien. Then a struggle started that still is going on. Often, it has taken the most unpleasant forms. I will probably never have any kind of peace since the day I promised the princess to build that floating channel."
[Viktor Schauberger's British Patent: Water Conduit.](#)

"Galilee discovered the movement of the earth. The church and the scientific world was outrageous. The pope threaten the discoverer by excommunicate him. Bishops and other high masters tormented him with long processes. Finally, hardly pressed by his colleagues, he was forced to reject his discovery. But, his last word was "even then, she moves", just before he died. But I was not thinking about Galilee, Archimedes, Meyer, Newton, Pythagoras or other discoverers of the laws of nature. I was only studying these logs and other matter that was heavier than water, which, during special circumstances, could swing like fishes in the water. I also studied the places where they floated straight up. Places where over powered thrust forces work and where these logs went to the bottom and came to rest."

"The snake, who was making such strange movements in the water, displayed the double twisted movement and helped me with my great success. One hundred thousand of the heaviest logs have followed the first one, as it was no difference in their density. Now I understand why my ancestors constructed their floating channels the way they did."

"The final preparations of the construction was nearly sabotaged by the Super Forester Officer, who promptly showed his superiority. Supported by the political leader of the forest department, he came to our working place and forbade all work and destroyed my carefully made schedule. I was forced to show my ideas and plans to a commission that was composed of hostile higher Forest Officials, monitored by the Domain Intendant."

"The "masters" declared that a 19 yard high catch-dam would not manage to stand the pressure from the water. They declared that if it would break, the flood would make enormous damages to the villages down below. I saw and heard the hostile and ruthless attitude at the commission. However, I had early learnt about the commission and been able to make some preparations. The reason why the commission was put together was that they wanted to see my fall."

"Therefore, I did not answer the Intendant but calmly walked down the stairs to the dam, took my rifle and shot two shots up towards the stream. This was the signal to the man that was posted along with the upper dam to open the great flood gate and let the huge amount of water rush down the furrow to the place where I stood. These men were faithful to me, but, the commission thought that I had gone mad shooting two live shots in the air. They ordered me to lay down my rifle and to get up to the plateau where the members of the commission stood wildly gesticulating."

"Then, a tremendous roaring came closer. I pointed up along the stream and around the closest bend, a 6 yard high brown wall of water full of whirling logs came rushing. "For Gods sake come up here immediately!" the Intendant yelled. The members of the commission waived crazily their arms and shouted exited into each others mouth. This behavior seemed quite mad from my point of view. After a short side view on these confused people I bent over the apparently weak dam wall and studied, very interestingly, the forward rushing mass of water, which, in a short time would hit the wall on which I was standing."

"This was what the members of the commission thought, who stood on the plateau holding their breath. But the masses of water did not act this way. Instead, they came as a weak breaker, turned around, and rushed with a tremendous force against the later incoming water. In this way, the two waves hit together, breaking each others force, while the logs raised straight up and even jumped as salmons high above the whirling water. The dam, which contained 1 million cubic meters of water, was filled in a short time and the dam wall stood easily where it has been placed. The man who opened the flood gate emerged. He did not give a single glimpse to the crowd that was standing on the plateau, but leaped down the stairs

asking: "well...did it work?" I nodded shortly, reloaded my rifle, and slowly walked up the stairs. "Now you had more luck than sense !" the Intendment said. I measured him top to toe with my gaze and said: "Mr. Intendment, I think the weak sense is to be found somewhere else!" Then I left him. The other "masters" followed silently talking about the event. When they where ready, the Intendant called for me and informed me that the dam should be carefully measured and tested by a consulting firm from Wien. Even though the dam had held, it is surely not strong enough, he said. These gentlemen came after a weak. Their result after measuring and testing, was, that the dam was twelve times stronger than it had to be, because of the skilled construction."

"I demonstrated once more the filling of the dam for these gentlemen, who in spite of careful calculations, could not explain how the dam worked. I made them notice the way the water hit the wall of the dam and how the opposing wave did, in fact, break down the after-coming main wave. I got the idea for the dam's profile from a hens egg, not from some kind of technical university!" **Viktor Schauberger**

"Nature as a master of knowledge", by Viktor Schauberger:

Everywhere in the nature, movement is created through differences in temperature and tension. In the cross sections of these the basic and natural forces of life are created. Natural events that has been untouched by human hands gives us the clue how to shape a new kind of technique. To do this, a good power of observation is needed. We must be able to understand the nature in order to copy the natures moving processes. As a master of the wild life in a distant forest domain which hardly could have been visited by humans, I was able to do the following observations, and these lead to the [implosion technique](#).

In Hetzau below the Ring, Die Ödeseen (The Desolated Lakes) are situated. After a long period of hot weather, they start to "bühlen" (bellow), as the local people name the thundering sound that emerges from the lakes at the same time, tornadoes of water, high as houses, rises from the center of the lake.

The following is an attempt to describe what I experienced: One hot summer day I sat by the shore and was just thinking of taking a cooling swim in the lake. At the moment I was going to do it, I noticed that the water of the lake started to twist into strange spiral shaped curves. Trees that had fallen into the lake moved from the shore and started to do a spiral shaped "dance" in a centripetal movement towards the center of the lake. Coming into the center, they suddenly erected vertically and were sucked into the deep with such force that their bark was peeled from them. Just like a person that is lifted up in the air by a cyclone and then falls down without any clothes. However, these trees never came up again.

The lake was calm for a short time, as it was satisfied with its pray. But this calm was an ominous waiting for the next event. Suddenly a rumbling sound was heard from the bottom of

the lake. At once a tornado of water, high as a house erected from the center of the lake and a thundering sound was heard when the grain shaped water column stood up. Then the column fell down, with waves swallowing against the shore and I had to run away when the water edge abruptly raised. What I had experienced was the primeval birth of water; renewal of water in a lake without any inflow. I had now started to understand, but still had a lot to learn. One more event helped me to fully understand this interesting question. As a young forest assistant, I used to row in a handy boat on a mountain lake that was situated close to our cabin. I was fishing and hunting ducks among other wild animals. My greatest wish was to be able to shoot a mighty sea-eagle. There was one coming every evening and circulated in peculiar ways over the lake. At the right moment, it let itself fall like a stone and the next moment while flying away, it had a big fish in its claws.

The biggest enigma was how the eagle always could catch live fish without diving into the water. The fish never came up to the surface. It took a long time before I was able to solve the riddle. I must really make a careful observation of the hunter and his pray, I thought. On a nearby rock, I found an old spruce, strong enough to carry me. One day I sat hidden in the spruce, armed with my binoculars, and was able to study every movement of the eagle and the fish which swam around in the water.

As always, he came at the exact moment, first flying close to the water's surface with a mighty cry and remarkable strong wing beats. It was as if he wanted to announce to his victims that he was here and wanted his tribute. Then the eagle rose nearly vertical in a spiral winding movement, now and then controlling its flight with a beat of its wings, making the spiral more and more close. Then, he let himself fall like a stone with his wings close to his body. Just above the water, he braked. Suddenly, there was a struggling fish in his claws. Heavily loaded, he flew, turning against the woods and was gone.

Logically, the most interesting thing was the behavior of the eagle. I forgot to watch the fish, who, apparently safe, swam around in a reasonable depth. But the next time, I also studied their behavior. The eagle came and flew its well known close spirals. What I now saw, was so incredible that I almost fell into the water. Unconsciously I imitated the movements of the fish when they completely copied the eagle's spiraling movements upwards. As thread on a string, they came swimming up against the surface, and as the eagle, making the spiral more and more closer until those who were in the center were pushed up above the surface. Then the shadow from the eagle came, a small whirl was seen, and he had one of the biggest fish in his claws and then sailed away. As soon as I had the opportunity, I studied this drama and was always so surprised that I almost got hypnotized by the movements of the fish..

The articles were taken in part from IMPLOSION magazine, article number 7.

THE POWER OF WATER

Are Its Secrets the Keys to Solving Today's Most Vexing Problems?

By Jeane Manning in Atlantis Rising, No 19, 1999 (reproduced here with the kind permission of Atlantis Rising)

Our thinking apparatus runs on water. Our physical bodies are two-thirds water, so obviously its qualities can heal or harm us. We now learn that water seems to remember and later convey "information". No wonder the most dynamic frontier in science today is water research. Or is it a re-search, I wondered, after encountering researchers who:

- a. show how neuroscience tends to confirm medieval concepts situating memory, imagination and reason in water-filled cavities of the brain.
- b. experiment with transferring, from water to us, the life-force energy chi, also called "prana" down through the ages, or
- c. study specially-shaped water pipes used by ancient Minoan culture in Crete; or
- d. show how the emanations from healers' hands change water.
- e. measure physical qualities of "holy water," or effects of conscious intent upon water's crystalline structure, or
- f. build prototype inventions aimed at using water as a source of energy.

Some study the big picture, such as the claim that rivers self-organize and energetically recharge themselves through spinning motions. And some point out the well-known anomalies that water is densest at 4 degrees Celsius (=39F), and strangely expands when cooled further, so that its solid state floats on top of its liquid state. Water as the "universal solvent" melds with nearly any element. Hydrogen, the main ingredient in water, is spread throughout galaxies, and ice is found in dust clouds in outer space.

The picture of water that emerges is what Marilyn Ferguson in her book Aquarian Conspiracy calls "the strangest stuff around." Learning about the mysteries of water evokes a primal fore-knowing, like a racial memory, perhaps pro-science, something we have known for a very long time.

Before our materialistic age lost the abilities to sense subtle "energetics", water was central to sacred rituals and symbols: Baptism, The holy river, Spiritual visions of the Ocean of Love, Myths of the flood or of creation, Drinking of sacred waters when visiting an oracle or a shrine.

The Sumerian goddess Inanna had a vase in place of a heart, from which flowed miraculous water. The Bronze Age civilization of King Minos at his city of Knossos on the island of Crete apparently lived by the principle that water should be returned to the earth in the same conditions it was when it was borrowed, treating all water as holy. Our era in contrast treats rivers and oceans as dumping grounds, and we face shortages of drinkable water. Dr. Karl Maret predicts that water will become the currency in the new century. Meanwhile researchers of water mysteries struggle for funding.

Ferguson notes: "The quest to understand water hasn't summoned up the capital and glamour of space research, although it may have more direct bearing on our lives. While humans burn rain forests and alter other factors that kept our habitat moist, we should remember the nagging suspicion that Mars was once a watery planet."

Let Water Move, Keep it Cool

We've had ample warnings. Austrian forest warden Viktor Schauberger (1885-1958) warned about wastelands that did and would appear on our planet when vast forests disappear. He observed the interaction between water and forest, such as the vitality of cold, pure water in tree-sheltered streams. He admonished: "Comprehend nature, then copy nature." He taught that water is a living rhythmic substance. In maturity, it gives of itself to everything needing life. However, water can become diseased through incorrect handling. Dying water harms animals, plants, and fish.

Whether stilled by a dam or a bottle, stagnant and warm waters begin to deteriorate. Conversely, at a cool 4 degrees Celsius (39F), moving water is densest, strongest and at its best carrying capacity. Wild rivers have inherent self-control mechanisms, if left alone to establish their own homeostasis, that is if kept cool with natural overhanging vegetation and allowed to meander around bends and therefore be lively with purposeful swirling motion. Shortsighted human engineering, clear-cut forests, mega-project dams, and rivers confined into canals all tamper with the circulatory system of our planet. Having interfered with the hydrological cycle, we reap floods, droughts, and other extremes of weather.

Olaf Alexandersson, in his book "Living Water" introduces Schauberger's insight into river management, water-fueled devices and energy. Its successor is the book by Callum Coats, "Living Energies", that could be the textbook for a new eco-technology, to construct or encourage processes which don't fight nature but instead work in harmony. Coats researched for two decades into Schauberger's discoveries from forestry to flood control to soil fertility and water purification. Hydrologists could learn by reading this book how crucial the small variations are in a river's temperature, and how water's spinning motion recharges it with subtle energies.

Water Power without Dams

The naturalist's warning echoes across the decades, "Prevailing technology uses the wrong form of motions." Twentieth-century machines leave behind waste products because their processes use the destructive half of nature's creation/destruction cycle, the centrifugal outward moving motions of heating, burning, pushing, radiating or explosion. They channel air, water and fuels into the type of motion which nature uses to decompose matter. Schauberger observed that the centripetal inward-spiraling force is the creative, cooling, sucking motion without friction, which results in increased order instead of destruction. He applied his understanding of cycloid spiral motion to a wide range of inventions; methods that are in harmony with nature's creative motion.

This "water magician" found solutions for agriculture, for energy generation, as well as transporting water in pipes that encourage the inward-spiraling motion of water. [Today's researchers follow and expand on Schauberger's earlier knowledge.](#)

For instance, the Swedish Malmo group use the phrase "self-organizing flow" to describe what they are creating, since Schauberger's technology made use of the natural orderliness spontaneously created by a system under the correct conditions. Meanwhile, new energy-generating processes, such as Randall Mills' Black Light Power, convert ordinary water into hydrogen and oxygen. Paul Pantone of Utah runs engines on water mixed with waste substances, and the air that comes out the exhaust pipe won't dirty-a white handkerchief held at the end of the pipe.

About a century ago, John Worrell Keely figured out how to run a motor on the power of cavitation or implosion, while alternately compressing and expanding water. He harnessed that which we dismiss as a nuisance- the water hammer- in water pipes. [Dale Pond, researcher of Keely's physics](#), says that Keely's Hydro-Vacuo motor created a water hammer shock wave, which, when synchronized with the wave's echo, "results in Amplitude Additive Synthesis, a process which tremendously increased energy accumulations in quick order." Pond warns that this resonance amplification is similar to the process which breaks wine glasses.

As a very interesting tangent to this, I took a hard look at a wonderful man's "water powered" invention - called "Whirlpower" and it holds great promise for a new energy source - a non-polluting energy source. Mr. David Dennard (May God bless his sole) has passed on from us, however, his work in water powered energy - Whirlpower - lives on. Please see the page I have prepared from his original work. Used by permission. [WHIRLPOWER](#).

Liquid Memory, Do We Really Know Water?

At Water-science conferences which this journalist attended in recent years such as the one at Seniamhoo Resort, WA, Nov. '98 (funded by Living Water International); a privately funded '97 meeting in Los Angeles organized by Linda McClain; and the Institute of Advanced Water

Sciences (AWS) symposium the previous year in Dallas, TX the one fact that emerged was that water is not a single homogeneous product of nature.

Water in living cells has unique structure, and clusters of its molecules have organized relationships. Another factor is what Schauberger called the "immature taker" vs. "life-giving mature" water. Since water without minerals is a relentless solvent, if we could distill 100% of impurities out of a batch of water, it would be dangerous to drink, leaching minerals from our bones.

Then there's the movement-vitality factor. Stagnant, bottled water, even though chemically clear, is dead compared to water in the rushing brooks. But it has to be proper movement. As water is pushed through cities in the unnatural confines of metal pipes, its energetic oscillations interfere, and the natural order in water's structure is canceled.' How do we know this? For one, German engineer Theodor Schwenk and his Institute for Flow Science, developed a technique for photographing the internal structure of water. In drops of water taken near pristine springs, a symmetric Rosetta pattern was revealed. On the other hand, the internal structure of damaged municipal water is chaotic. Chemical contaminants and electromagnetic pollution compound the damage and cause chaotic clustering of water molecules. These meetings wrestled with questions such as whether 'living water' is an organized state of matter and energy, and capable of storing and transmitting information. If so, the implications go beyond homeopathy and 'energy medicine" and into the interaction between water and consciousness.

Dr. David Schweitzer, grandson of Albert Schweitzer, is the first scientist to photograph the effects of thoughts, captured in water. This shows that water can act as a liquid memory system capable of storing information. David Schweitzer first stepped into this trail by becoming an authority on blood analysis. He learned that blood cells express themselves in sacred geometry and their harmonious shapes and colors. Since blood cells hang out in water, he looked farther into that substance for answers about our thinking processes. After ten years of observing blood, in 1996 he made the discovery which opened the door to photographing the stored frequencies in homeopathic and natural remedies and to researching the impact of positive or negative thoughts on bodily fluids.

"Having studied the relationship between the brain, cells and emotions," he told Joseph Duggan in Vancouver, "I came to realize that certain trace elements were needed to send information from one area of the brain to another." Minerals alone could not convey information. To find out if the carrier was water itself, Dr. Schweitzer experimented. French scientist Jacques Benveniste had already shed light on the memory of water in homeopathy. He and a dozen other scientists demonstrated that water can retain a memory of molecules it once contained. Nature magazine in 1988 published their experiments showing that if water containing antibodies was diluted repeatedly until it no longer contained a single molecule of antibody, immune cells still respond to the water. The publication drew outrage from orthodox professors, and the magazine later sent a team to Benveniste's laboratory including the

magician James Randi and Walter Stewart, a self-appointed investigator of scientific fraud. The team judged the French scientists' results to be a "delusion." However, a recent book by Michel Schiff says the slander of Benveniste was the delusion.

Dr. Schweitzer says, aspects of the homeopathic research couldn't be measured by the investigators' instruments. The witch hunt in France didn't stop him from radical thinking. He remembered Albert Einstein's idea that particulate "light bodies" act in ways we don't yet understand. Waking up one morning with insight on how to make these bodies visible, Schweitzer began working on a fluorescent microscope at a certain light intensity. He wanted to see somatids change in response to thought and other influences. Just before the water on the microscope slides evaporated, he saw certain formations develop "dependent on the thoughts or energy atmosphere it had been impregnated with." I observed that this cluster could be modified at will." Further work showed that microscopic light bodies in the water intensify in the presence of positive thoughts. They shine brightly if thoughts are backed up by emotion, and it makes a big difference whether the emotions are negative or positive.

Intrigued by the tiny light-bodies, he tested holy waters of religious faiths, from Italy, Russia, Yugoslavia and North America and saw somatids floating even after years of being bottled on shelves. "This means there is an ideal balance when somatids never touch,' each other, which gives them the greatest capacity to store information." But when he studied homeopathic remedies, careful storage of energy medicine is crucial. French immunologist Jacques Benveniste had learned that electronic circuits can impress lasting information upon water, and low-frequency electromagnetic radiation and heat destroy homeopathic strength. Further, Dr. Schweitzer has a warning about purified water we buy in clear plastic bottles that have been exposed to fluorescent lighting. When we drink only this water, our lips dry out and become chapped and cracked. "Normally, drinking water does not dry out the mouth, but fluorescent lighting changes the structure of water such that it dries out the mucous membranes."

Randy Ziesenus, of Edmund, Oklahoma, says anyone can personally improve the water they use. "It's amazing what happens when you take a glass of water and hold it between the palms of your hands and ask your higher Self to work with that water and whatever you need for your highest good. And then drink it; incredible what that little (ritual) does." Ziesenus is president of Bio-Com, a company that specializes in the development of biotechnology using radio-frequencies (RF) to alter water's bonding structure. 'He says "if you drink water that's harmonious to the human body, water will pass through the body within ten to 15 minutes. Then you've got to go to the restroom. The (harmonious) water will carry out toxins."

One of his inventions condenses water from air." That's one of the biggest things I've been working on by using frequencies to draw moisture out of air." He and researchers from Los Alamos National Laboratory are working on " a program where you can take a photocell device, put it out in the desert, and it will make a gallon of water overnight." The unit is powered by photovoltaic (electricity from sunlight). Ziesenus agrees with Dr. Scheitzer's claim that our AC electricity leaves a harmful imprint on water.

At the Living Water conference, professor emeritus William Tiller quietly obliterated the conventional view that humans cannot meaningfully interact with their experiments, "Conventional science would even more emphatically state that specific human intentions could not be focused into a simple electronic device, which is then used to meaningfully influence an experiment in accord with the specific intention. We have made a valid test and found conventional science conclusion to be in serious error." In his work Dr. Tiller describes the people who are capable of sustaining high-coherence in intentions as "imprinters." They, for example, sit around the table while putting out the intention "to activate the indwelling consciousness of the system" so that the pH of the experimental, water increased or decreased significantly compared to the control. It did. How does he explain this?

The theory used by Tiller and co-researcher Walter Dibble, Jr., is multidimensional. These scientists see water as a special material, "well suited for information/energy transfer from this frequency domain into our conventional domain of cognition, the physical." Regarding the factor of mental capability of whether imprinters know enough science to visualize changes in pH, Dr. Tiller said, "the unseen intelligence of the universe is an even more important factor." Later he added, "in my view it is the spark of Spirit in the cells that give rise to the life force."

Another scientist at that meeting, Dr. Glen Rein, points out, that physicists know about the existence of energy fields with properties, which are not explained by classical equations. He refers to the non-classical fields as quantum fields. Rein's work again shows that this non-electromagnetic energy-information from the primordial vacuum of space- can be stored in water and can later communicate with living cells.

Perhaps Viktor Schauberger's most startling observation was that subtle qualities of water can affect humans mentally and spiritually, either revitalization or deterioration of society. Dr. Thomas Narvaez has proven to his own satisfaction that a vitality factor exists and can be increased or decreased in water by human activity." We now see that our thoughts not only affect our own bodies, but also the bodies of those around us. Members of this group (speaking to the Institute of Advanced Water Sciences, in 1996) who bottled water or who worked with broadcasted energies like crystals or magnets therefore have a responsibility to keep our view of the world upbeat and positive."

An "Egg - shaped" Compost heap...?! So what's this about? Anyone with an interest in their own health, in agriculture, ecology and even the well being of our precious planet must include the knowledge of Viktor Schauberger in their studies.

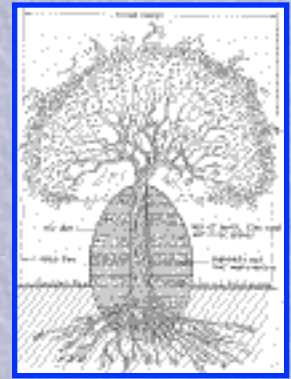

By the close observation of nature, Viktor unraveled the secrets of our planet's life giving liquid, the blood of our earth and most valuable resource WATER. Alas, much of his work fell on deaf and cowardly ears, for so powerful were the things he clarified that his inventions were abused, ignored, destroyed or invalidated by those of self vested power with small minds and covert intent.

If he had been heard, understood and embraced, many of our worlds troubles would be resolved. From his technology of "Living Water" comes an endless supply for drinking and even enough to quench the thirsts of deserts so that they may grow crops. His understanding of it's nature of flow led to devices that harness the power of centripetal motion and implosion. From the vortex comes the frictionless generation of electricity, powerful kinetic motive power and levitation! A word of advise to all who surf here...Search out and learn the knowledge of this wise man.

Why an egg shaped compost heap? Find out for yourself...pick up a copy of "[Living Energies](#)" by Callum Coats, listed below. The following is just a peek at some fundamental data Viktor Schauberger has revealed. It has relevance for us all, and I trust it will stimulate you to think, then take action. Here are some notes from the book "Living Energies"...enjoy... and - **THINK!** ... FDG.

Water, as it relates to drinking water. Without water, organic life quite simply, would not exist.

We all require it, and when we use poor quality water we covertly compromise our good health. Global thoughtless use and abuse of our earths' water has now gotten to a point where our entire planet is at risk of pollution and disease and ultimately major planetary catastrophe. Many an opportunist will profit from the "clean water" that he sells, you are already being encouraged to use it, and guess what?? The water you buy in the shops is still not up to the vitalizing, nourishing quality your body deserves...!! So, in the here and now, mankind's continued ignorance and abuse will destroy the fundamental resources of our earth... it's water, air and soils. Without these simple things, we can never expect to see prosperity, good health or personal freedom as God-given human rights.

So, lets take a look at what Viktor Schauberger reckons, when it comes to determining what kind of water is good to drink:

Distilled water - Distilled water is evaporated to steam then condensed as a pure fluid; it appears chemically clean. In this state, water by it's intrinsic nature, will draw to it's self

anything it can dissolve in order to fulfill a basic function...that of a carrier of substances. Distilled water will only remain so, as long as it is not given the opportunity to make contact with soluble materials.

Drinking distilled water as a regular routine is dangerous!! It acts as a purgative and will strip trace elements and minerals from your body!! Don't buy too much of this stuff at the shops and don't use a distiller to drink from...you have been warned!

Rain water - With an unpolluted atmosphere, rainwater is the purest naturally occurring water in nature, but unfortunately much of our globe no longer has this occur as acid rain is a direct consequence of our ignorant ways. Like distilled water, rainwater is unsuitable as drinking water and should also be avoided over a long term basis. Rainwater could be seen as a young adolescent that has yet to go through the maturing process the earth provides.

Juvenile water - This water comes from the ground, often from great depths and forced upwards (maybe appearing as a geyser) or pumped to the surface as from a deep bore. It is still lacking it's quota of minerals and is deficient in dissolved carbons. As drinking water goes, it's marginal at best.

Surface water - It has contact with the earth so the opportunity of it to dissolve materials is present. Keep in mind that pollutants with in a particular area are definite minus points. Surface water is also generally exposed to direct sunlight, and when collected into and stored in an open dam, the water's energy value becomes damaged by the influences of the heat and light. Note: drinking water should never be exposed to direct sunlight...!!

Groundwater - Retrieved from the ground, this water is getting pretty good as it generally has a high dissolved mineral content. In it's journey above the impervious sub stratum it may appear as seepage springs in gullies, or as shallow wells.

Spring water - The prime source of vitalizing drinking water. It is ripe in minerals, trace elements and dissolved carbons. It's high state of vitality is seen in it's shimmering energetic bluish color, no other water looks like this. The water rises from the earth with the qualities of levitation, it is very cool and will approach the anomaly point of +4 C. The streams they create are collection points for drinking water, and provided the stream is not contaminated by agriculture and human habitation, it remains very drinkable, well worth the finding...

Viktor invented a machine that could use most any unpolluted water and process it into spring water. With this machine he acquired the name "The Water Wizard" because the water he produced had powerful healing qualities. Viktor was able to achieve the remission of cancer for many people, but he soon came into opposition with the authorities who accused him of charlatanism and being unqualified to practice healing. His machine was confiscated and destroyed...!!!

Storage of drinking water.

If you are fortunate to live within reach of true spring water or quality ground water, I'd strongly recommend that you collect it, take it home and drink just it.!!

On "missions", I've traveled to get good, pure, drinking water, and (in Europe) I've collected it in large glass bottles. Brim full the bottles; then seal them with a cork. Ensure you leave no air in the bottle as this helps to stop the water from slopping around inside. Secure them well for your journey, then cover to keep out sunlight. Once home, transfer the water to your storage vessel. A suitable storage vessel for your drinking water must comply with a few fundamental parameters.

- 1.) The vessel needs to prevent light from reaching the water within.
- 2.) The vessel will encourage the water to circulate via an internal temperature gradient.
- 3.) The vessel will keep the water cool.
- 4.) The vessel has a lid to prevent dust contaminates from entering.

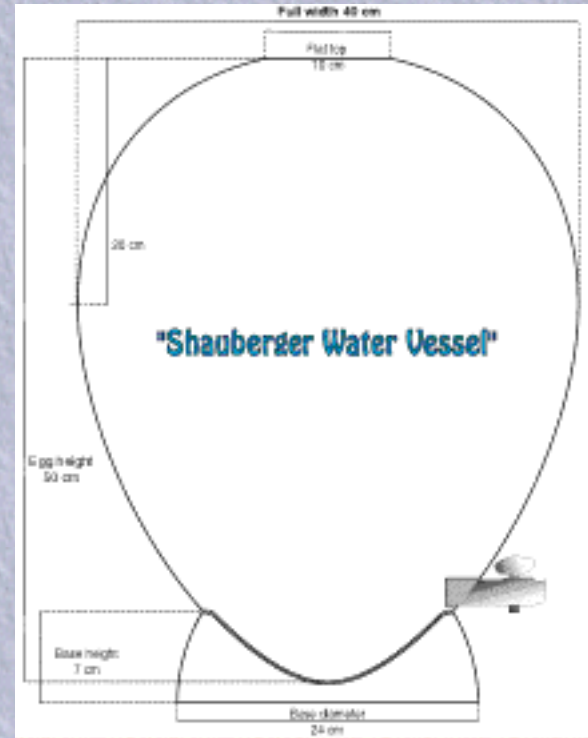

With these parameters in mind, an egg shaped container is made from terra cotta clay. The terra cotta is porous and allows evaporation to occur on it's outside surface thus facilitating both cooling and circulation. It stands on a vitrified clay (being water proof) base. It has a lid and ideally a spigot tap made from wood. You'll see a design drawing I've done for the vessel. It has a 40 liter + water capacity. You can purchase one of these "egg shaped" Schauberger water vessels from one of the links, below. Order through the "Center For Implosion Research". Back to the story...see if you agree with, or maybe even "know" the answers to these questions:

Questions for Science asked by Viktor Schauberger:

ENERGY

- What is it that keeps the Earth floating in space?
- Why does a top stand upright when it is spun from the side?
- What is temperature? What is heat?
- What is cold?

What is energy?

What is evaporation?

What is vaporization? What is dissolution? What is combination?

What is absorption?

On what effects are these processes founded?

MAGNETISM

Why do the magnetic lines of energy run from south to north?

Why does the Earth rotate from west to east?

THE SUN

What serves the sun as a carrier of light and heat, if, in the view of our learned scientists, space is a vacuum?

Why do gases condense with a decrease in temperature?

Why don't the fiery gases of the Sun, with supposed temperatures of over 6000°C, stream out into space?

Why is the light and heat in the tropics more diffuse and at the poles the Sun's light more intense and its radiant heat less?

ATMOSPHERE

Why doesn't the Earth's warm air rise?

Why is it so cold at the top of a mountain, i.e. nearer the sun?

Why in our houses is it warmer nearer the ceiling and colder at the floor, when an artificial source of heat is used?

Why does marble expand with heat and why doesn't it contract again with cold?

EVAPORATION

Why is the desert so dead despite all the heat?

Why do damp tiled roofs dry out from the eaves towards the ridge?

WATER

Why does the groundwater in wells rise far above the surface of the ground?

Why don't wooden posts rot under water, but above it always?

Why can rising cold water pierce through the hardest rock?

Why does water pulsate and breathe?

Why does groundwater manage to remain on the sides of mountains?

Why, growing colder and heavier, does it rise upwards?

Why does it frequently spring from high peaks?

RIVERS

Why do west-to-east flowing watercourses fertilize their banks?

Why are the banks of east-to-west flowing rivers so barren?

Why are the banks of south-to-north flowing watercourses fertile on one side only?

Why do rivers flowing into cold seas migrate laterally to the north?

Why do deltas and estuaries develop?

Why does a trout stand still in a raging torrent, as if by magic?

THE SEA

Why is the water at the poles warmer at the bottom?

Why is the sunlit surface at the poles so icily cold?

Why doesn't the warmer, lighter bottom-water of the sea rise upwards?

Why are the water temperatures at the equator so warm?

Why is it that it gets colder with increasing depth?

Why does it get warmer again below the boundary layer of +4°C?

Why does life below this boundary layer begin anew?

Why does the salt content of the seas vary?

Why do herrings migrate northwards in winter?

Why do deep-sea fish glow?

Why can the warm Gulf Stream push the cold seawater aside and wend its way for thousands of kilometers over mountains and valleys in a reversed temperature gradient without the assistance of a mechanical gradient?

BLOOD

Why do cold-blooded animals carry fever-inducing poison? Why does a cold fever occur in the tropics?

Why does a warm fever arise from a chill? What is fever anyway?

Why is our body-temperature subnormal when climbing a mountain and above normal as we descend?

Why does the heart beat in our breast?

Who gives this muscle its impulse to move?

Where is the motor for this pump? Why does blood circulate in our blood vessels?

Why do the fluids in a chicken's egg circulate without a heart? Why do we breathe day and night, when asleep and even when totally unconscious? Does the heart beat because we breathe, or do we breathe because the heart beats?

TREES

Why have light-demanding timbers a thick bark and shade-demanders only a thin one?

Where is the heart of a plant?

["Living Energies" by Callum Coats](#) gets pretty in-depth on most every subject covered on this website. In all actuality, this website would not even exist (the parts on Viktor Schauberger) without Callum Coat's contribution. The double legacy of big agribusiness (factory farming) is chemically-fried soil that sloughs off into rivers and oceans with a load of pesticides, and consumers whose health is also going down the drain. And the good news?

The better methods of farming (biological agriculture) are also the cost-effective methods, according to many researchers and experimenters, including a British researcher who lives in Australia - Callum Coats. After nearly two decades of research, he wrote the fascinating book *Living Energies*, which includes a section on "biological agriculture." *Living Energies* focuses on the concepts of Viktor Schauberger (1885 - 1958). Schauberger was an Austrian genius who began his study of nature's motions while he was working as a forester observing pristine ecosystems. His later inventions harnessed nature's simplicity for a variety of technologies: water purification, river and flood management, soil fertility, propulsion, and even home power generation ("free energy"). An increasing number of today's scientists are acknowledging that his apparently radical concepts are actually quite brilliant. Schauberger's motto of "comprehend and copy nature" points our way out of the insanely destructive technologies of the 20th-century.

The book, *Living Energies* (see second book below), gives a detailed description of how to build an egg-shaped compost heap for maximum energizing of the materials inside it. This is only one of many practical - we can certainly say "down-to-earth" - topics covered in Coats' book. It should be a required textbook for environmental science courses. Unfortunately for our world, the concepts of subtle energies are not yet accepted by those who decree what textbooks are studied in our universities. Let's do what we can to change that situation! Callum Coats has shown us the way - research, experimentation, and then communication with others.

Two Products That I Endorse are the "Electron 3 & 4 Living Water Machine" and the "Wellness Filter Line":



[FutureTech Today](#) introduces the [Electron 3 & 4 Living Water Machine](#). This machine is being marketed through Future Tech Today, made by "For Health Reasons" of Chicago Illinois, USA. (makers* of quite probably the best water filtration system, based on Victor Schauberger's ideas, of course, on the planet! Purer Distilled Drinking Water:

When vapor turns to rain, it passes through temperature gradients where the temperature is continually changing with oxygen. This process stretches and contracts the H bonds that hold the molecules together...this creates ENERGY! Plant diseases are caused by viruses and bacteria, and our method of autoclaving them, using INTENSE HEAT, DESTROYS THEM (NOT just boiling).

The research chemist and others spent thousands of dollars on every product on the market, and ONLY OUR METHOD prevented the diseases in plants and caused incredible growth by just dropping plant buds in the water. Root growth 2 1/2 inches long compared to 1/8 of an inch in any of the others during the same time frame...even compared to water with nutrients added to it!! This test was REPEATED over a period of three YEARS ...so there is no mistake!. The BOTTOM LINE is that today's ordinary water is DEAD! Why would ANYBODY want to use DEAD water, and yet most people

do! If you can afford the rather steep price of their units, it is well (no pun intended!) worth the price, from personal use, on my end.

*The company that originally produced this unit is listed below - "For Health Reasons" of Chicago, IL. The company SELLING (marketing) the unit is [FutureTech Today](#)... "Future Tech Today was founded in 1998 with ambitions to break the latest energetic healing technologies to the general public while maintaining a research and development program allowing them to bring tomorrow's technology today. The idea was to represent the latest technological research in the fields of energetic medicine, water vitality, and EMF (electro-magnetic field) protection products. They represent products and technologies from all over the world, many of which are in very early stages of production or still in research phases; in this way they give the general public a preview of technologies to come..." (from their website, and used here for endorsement sake) FDG

water-revitalizer.com

ozonedetox.com

rife.biz



[FutureTech Today introduces the Wellness Filter!](#) This is the **Wellness Filter®**, and comes in various sizes to suit individual needs. In my humble opinion - it's the best on the market, today. Pricy, but well worth it. Again, this product is offered through FutureTech, Today. For website info, use either their link - [FutureTech Today](#) - or <http://www.wellness.com.au> (If you go to wellness.com.au directly, you can even become an associate, an affiliate, or a partner-type program with them if you meet their strict company requirements).

"The Wellness Filter® offers you and your family a quality of water that Nature has provided to only a select few. By using natural purification processes in combination with advanced technology, the Wellness Filter® produces what many believe is the best drinking water on Earth. The Wellness Filter® not only removes harmful contaminants but it also enhances the water through a patented process that creates a quality of water beyond the reach of conventional water filters. Clean water plays a vital role in your health, fitness and appearance..." (from the FutureTech Today website).

Books I Recommend:

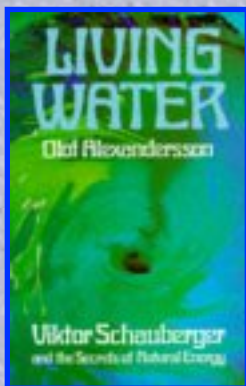

The original translation of Viktor Schaubberger's work, "[Living Water](#)", by Olof Alexanderrson...start here, and get each one in order. This is an excellent, brief introduction to the thought of Viktor Schaubberger, and I hope it inspires works which are more complete. Callum Coates' books reach in this direction, but what is really needed are more people to read these books, synthesize their information, and come up with new and original books which take us further into depth in these areas. This will probably involve synthesizing the work of Schaubberger, Grander, Bienveniste, and others. An understanding of

Schauberger is very important for those attempting to reconstruct an Indigenous European Perspective. Schauberger has the elements of a modern water shaman, and his shamanic / intuitive techniques of letting his body float with the water should be closely correlated with what Hans Peter Duerr has to say about "out of body" experience in his tome "Dreamtime". Although Schauberger lived in the 20th Century, his perspective allows us to imagine back what earlier indigenous practitioners may have been like. The Colonial, Imperialist Europe is only one side of the coin of Europe. We must also include the suppressed indigenous, pagan, and green sides. Significantly, the Inquisition represents a watershed in European history where a great deal of the indigenous healers and theorists were wiped out in holocaust proportions. An understanding of Schauberger, coupled with an appreciation of Steiner, Hildegard of Bingen, Hans Peter Duerr, and others, will allow us to reconstruct what a noncolonial, nonimperialist Europe was like. Understanding water's nature is essential in this regard, for water forms the basis of our understandings of flow. Furthermore, understanding water's energetic qualities will help us understand how it interacts with the body. Traditional Chinese Medicine, for example, would benefit from an accurate and holistic understanding of water's qualities. In short, this book is an excellent appetizer.

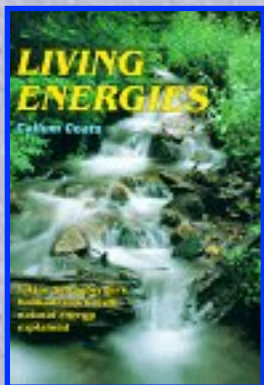

The book that started it all...[Living Energies](#), Callum Coats first Viktor Schauberger book. If you only buy one book, this would be the one to get. Fantastic. Living Energies, May 23, 2001

Reviewer: Frank D Germano, from Tafton, PA United States: This book started it all! Callum Coats basically brought to "light" the resurgence of interest in Viktor Schauberger's theories. This is truly a brilliant work. Water as a carrier of vital energy information, trees as bio-condensers of energy between the deep earth and the sun, how self-cleansing rivers nourish the landscape, how the future of the earth depends on the replanting of natural forests, revolutionary agricultural implements, free energy heater-coolers, jet engines and gravity defying machines invented by Schauberger in the 30's and 40's, home power generators...it's pretty much all here. It was a hard book for me to put down once I started reading, and I go back to it continually for reference. This book pretty much sums up Schauberger's work, which Coats then compartmentalized and expanded in the "Eco-Technology" series with four other books. I would highly advise getting this book, first, and reading it thoroughly, before moving on to the series, as it is a fascinating preface into discovering who Viktor Schauberger WAS, and learning just how far-reaching his theories were, and applicable to us, today. FDG.



Continue the journey...Viktor Schauberger:

[Page Three](#)

References:

- Alexandersson, O. 1996. Living Water. Viktor Schauberger and the Secrets of Natural Energy. Gateway Books, Bath, UK.
- Andrews, T. 1996. How to See and Read the Aura. Llewellyn Publications, P.O. 64383, St. Paul, MN 55164-0383, USA.
- Asimov, I. 1977. The Collapsing Universe. Hutchinson, London
- Coats, C. 1996. Living Energies: Viktor Schauberger's brilliant work with natural energy explained, Gateway Books, Bath, UK.

- Eisen, J. 1994. Suppressed Inventions and Other Discoveries. Auckland Institute of Technology Press, Private Bag 92006, Auckland, New Zealand.
- Gerber, R. 1988. Vibrational Medicine. Bear & Company, Santa Fe, New Mexico.
- Ludwig, W. 1991. in Treven & Talkenhammer, eds., Umweltmedizin (Environmental Medicine), Mowe-Verlag, Idstein.
- Pond, D. (editor) 1996. Universal Laws Never Before Revealed: Keely's Secrets. Understanding and Using the Science of Sympathetic Vibration. The Message Company, 4 Camino Azul, Santa Fe, NM 87505.
- Senf, B. 1997. Die Wiederentdeckung des Lebendigen. (The Rediscovery of living [energy]) Zweitausendeins, Frankfurt am Main. Germany.

[[the Telsa & Schauberger Bookstore](#)]

VIKTOR SCHAUBERGER:

[[Water Power - Vortex Theories-I](#)][[Water Power II](#)]

[[Viktor Schauberger -1-](#)][[Viktor Schauberger -2-](#)][[Viktor Schauberger -3-](#)][[Viktor Schauberger -4-](#)]

[[Christian Links](#)]



Schauberger's inventions

[[PAGE ONE](#)] [[PAGE TWO](#)] [[PAGE THREE](#)] [[PAGE FOUR](#)] [[Implosion Technology](#)] [[VORTEX SCIENCE](#)]

shop now

AND SAVE

Save big on thousands of products!

Computers
Books
Music
DVDs

and you're done.™

Click Here

<p><u>The Fertile Earth</u> Viktor Schauberger... New \$13.57!</p>	<p><u>Living water</u> Olof Alexandersson...</p>	<p><u>Energy Evolution</u> Viktor Schauberger... New \$13.57!</p>
<p><u>The Schauberger Companion</u> Callum Coats New \$21.95!</p>	<p><u>Living Energies</u> Callum Coats New \$19.95!</p>	<p><u>Land der Traumer</u> Rene Freund Used \$9.00!</p>
<p><u>The Water Wizard</u> Viktor Schauberger... New \$12.89!</p>	<p><u>Hidden Nature</u> Alick Bartholomew New \$35.00! Used \$23.00!</p>	<p><u>Living Energies</u> Callum Coats New \$17.79!</p>

(Prices May Change) [Privacy Information](#)

" I must furnish those, who would protect or save life, with an energy source, which produces energy so cheaply that nuclear fission will not only be uneconomical, but ridiculous, This is the task I have set myself in what little life I have left" Viktor Schauberger...a letter to Aloys Kokaly, in 1953.

If you think about it for a while, I am sure you can think of many ways that nature uses a spiral, or vortex pattern. We all are familiar with the conical windings of sea shells, the spiral patterns of stellar galaxies, and even to ourselves, with our RNA and DNA structures in our bodies. Hurricanes, twisters, tornados, and cyclones, all of which are some of the most destructive storms and forces on our planet, all form the classic vortex spiral pattern. You must be familiar with the water flow out of bath tub, forming a vortex spiral down the drain...it spirals in different directions depending on which part of the planet you are on - counter clockwise in the northern hemisphere; clockwise in the southern hemisphere. You may have even emptied liquid from a bottle by shaking it to form a vortex and noticed it emptied quicker than if you had not.. It takes only a small amount of energy to get the vortex going, but, with the aid of gravity, the mini

cyclone continues until the bottle is emptied. An American inventor built and patented a water ram pump from information involving the spiral flow which he claims to have gleaned from a visit to the Egyptian Pyramid. There may yet be a truth in the old laundry detergent advertisement of a white tornado in a bottle, admittedly, a big one. Mankind's only real attempt to utilize the spiral vortex is in weapons of destruction by using a rifled barrel in arms ordinance to give projectiles flight stability, distance, and accuracy.

Common sense, and Viktor Schauberger's own inventions, give us clues to how we may be able to tap this almost seemingly limitless energy potential. We have already discovered, through Schauberger's own theories, and later confirmed by scientists such as Hebrand, and Hasselburg (see my "[water power](#)" page) that there is more energy and power available in flowing water, accelerated through a spiral vortex than is available from the same volume of water restrained and then flowing over a dam, on a scale of 9:1, in favor of the former, **vortexian** power. Clean, environmentally friendly, unlimited power is available all around us, yet, due to our conditioning from "big-business" and others, we refuse to accept and look closely at these alternatives. Schauberger did...and, following his lead, we will as well. Let's continue with our story.

During World War Two, Victor Schauberger was interned in a Nazi concentration camp and was forced to work on a flying disk project using his ideas. (If you missed [PAGE ONE](#) and [PAGE TWO](#), go back now, and review for the actual stories!). It is not known if the project was completed, or, if the saucers actually flew in Germany. Reports vary, and no **confirmed** documentation remains. It is rather convincingly coincidental, however, that our own (US) pilots reported "strange flying disks" over Germany just prior to the War's end. After World War II, Viktor migrated to the United States on promises by various agencies (CIA) to help him develop and test his ideas. Those promises later proved to be hollow. He went to a facility in Dallas Texas, and under uncertain direction, signed over all of the rights to his inventions and patents, to, none other than the US government (Army, Navy...who knows?!). He was sent back to his home-land of Austria, only to die, broken and disillusioned five days later. It would make a great headline for the 'National Enquirer'...and unfortunately...it's TRUE!

Schauberger may have died, but some of his ideas remain. He suggested that we look at the **cooling** (implosion) cycle and not always be focused on the waste-heat produced from our devices (fission, explosions from internal combustion engines, jet turbines, etc.). The **explosive** force we now use to provide energy, such as in the automotive combustion cycle, for example, tends to be harmful to the environment, while the **implosion** equivalent (Nature's way) may not be. We should be working with the laws of natural forces instead of using wasted explosive energy to oppose them.

In order to power its machines, today's **science** gives priority to an oxidizing or metabolic process, wherein oxygen (atmospheric oxygen)- the natural stuff of breath - consumes the lower oxide or pro-oxide (a type of metallic calc or calx) which contains valuable growth-

factors and which is a geo-spherical formative substance. This interchange of substance (metabolism) is referred to as the 'normal' combustion process and people are of the mistaken opinion, that it gives rise to those carrying, shifting and orienting forces that move and animate our bodies. This 'normal' process of combustion, whose dynamic product Nature uses to break down, decompose and eliminate the evolutionary unfit, is triggered in such a way that at about +40 degrees Celsius (+104 degrees Fahrenheit) through the application of heat or fire, the oxygen becomes aggressive and belligerent. If it is heated further, then it becomes even freer and more dangerous, leading to the decomposition of blood, water and sap. At this point all life-functions of whatever kind cease in all growing, living and autonomously moving things...Viktor Schauberger's approach, as we shall see, is quite different.

The invention (The Repulsine) makes use of the fact that the presence of certain substances, especially metals such as copper, silver or gold, for example, or those substances collectively termed synthetic resins (plastics), which are decisive for the progress of the vital functions in liquids or gases (air) and whose effect can, in part, be described as **oligodynamic** (decay-producing effect, as envisioned by Schauberger). Therefore, if the said course of motion of the substances to be dissociated is also allowed to proceed "**oligodynamically**", then the severing of the atomic bonds can be successfully achieved to a large extent and considerable energies freed. These freed energies can readily be brought into new combinations, such as for the further development of the atoms of primary gaseous substances into liquid or even solid formations or these energies may be drawn off or diverted in some other way.

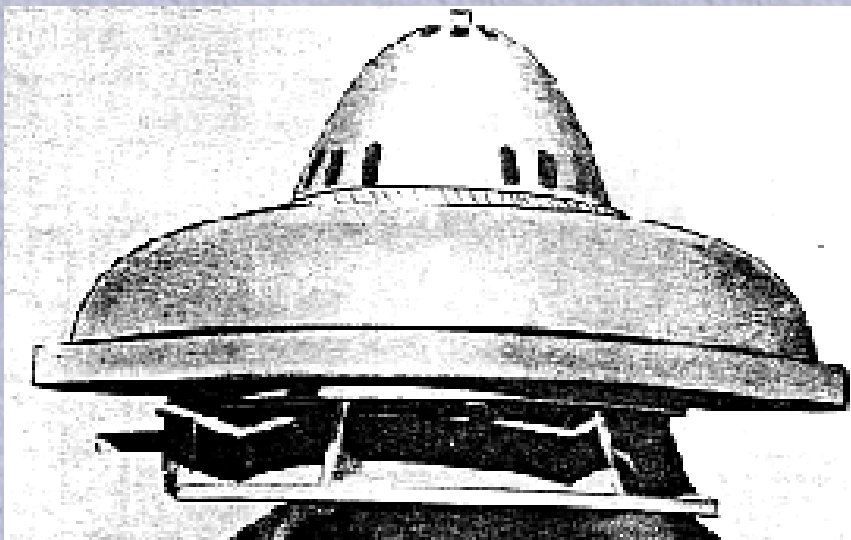

On this page, I will try to give you a possible explanation about the working principle of "**the Repulsine**" flying saucer from Viktor Schauberger (1938-1957). Simply "click" on the image thumbnails for a larger view. This document is the synthesis of a fine analysis on pictures of real working devices, on Schauberger's researches in vortexes (implosion principle) and on some technical papers from Henri Coanda (1886-1972) and Bernoulli's principle. [PAGE FOUR](#) of this

site will offer even more detail, and quite a number of surprises, as well.

An original picture-sketch of the Repulsine (Left) : A flying model of a Schauberger **Repulsine, Type A**, tested in January 1940. This device has been built with copper and uses a very high speed motor for the main vortex turbine. The Repulsine Type "A" device is an Electro-Aero-Dynamic device (E.A.D.) and uses two effects :

1.) The Coanda Effect: a pure Aerodynamic effect based on the Bernoulli's principle.

2.) The Electro-Dynamic effect : The high speed vortex in the "vortex chamber" produces an electric, charged separation effect, called "the diamagnetic effect " by Schauberger. These two effects, combined, create the so-called "implosion effect".

Machines of Genius - The Repulsine, or "Flying Saucer" of Viktor Schauberger:

The following is taken from the Schauberger British and/or Austrian Patent Number 146,141 March 4th 1940, filed in Austria. The entire patent information can be found in Callum Coats book - "[Energy Evolution](#)" page 170-195. Additional comments, construction notes and design parameters by [Frank Germano](#), [Martin Dorantes](#) & [Mr. Robert Bailey](#)..

Two circular sheet metal plates made of silver-plated or amalgamated copper are press-formed in such a way that they are endowed with a waveform shape, and are superimposed on one another in such a way as to create a waveform, interstitial space. Both plates are maintained at a distance from one another by already known methods. The lower plate, is attached to the backing plates, which are insulated from one another by a hard rubber plate. On the upper plate, two, three, or more, cover plates are mounted in such a way that they initially rest on the wave-crests of such plate before gradually tapering downwards into the wave-troughs. In this way, the narrowing pressure-chambers are formed, whose longitudinal axes run parallel to the circumference. On the inner inclined surfaces of the upper plate, narrow slits are incised. The central component incorporates a spacer ring. Spacer rings, incorporating nozzles can be provided in the interstitial space. Furthermore, the hollow shaft opens into the cup-shaped component, whose inner surface is advantageously fluted, and which has exit openings into the interstitial space.

If the device is caused to rotate rapidly, then the liquid or gaseous substances entering the pressure-chambers will be impressed downwards and sideways through the slits, into the interstitial space, in which a considerable suction evolves, so that the space acts as a suction-chamber. The whole device therefore represents a kind of multi-stage centrifuge, each concentric wave being regarded as a stage. It can readily be understood that the liquid or gaseous substance present in the pressure-chamber, having been subjected to strong pressure forces here, immediately passes through the slits in the pressure-chamber walls and partially expands. At an appropriate rate of rotation, a maximum pressure will be reached, under which a bio-electric energy evolves, with whose aid, the primary combinations of the through-flowing liquid, or gaseous substance, will split up, whereupon these freed energies can be synthesized into any desired form or be drawn off.

As material for the two plates, silver-plated or amalgamated gold, or synthetic resins (plastics) can be used. If plastics are used, and seawater, for example, is impelled through the suction-

chamber, an insipid fresh water is obtained as a result of this process. The arrangement can be so designed that like upper plate, the lower plate can also be provided with cover-plates, so that the pressure-chambers lie on both sides of the suction-space.



An original picture of the vortex turbine. The vortex area is in the middle. The vortex chamber has been removed. A front view of the "**Repulsine Type B**", showing the primary hull and the vortex chamber. "**The Repulsine Type B**", left. Again, "click" on any of the images for a full-size view.

When the main electric engine is started, the Coanda effect begins to create a differential aerodynamic pressure between the outer and the inner surface of the primary hull. At a higher speed, the vortex chamber becomes a kind of high electrostatic generator due to the air particles, in high speed motion, acting as an electrical charge transporter. The Repulsine will begin to glow due to the strong ionization effect of the air. Now, we have all the ingredients for a continuous and strong Aether Flow along the main axis from the top to the bottom of the craft...The radial air pressure required for lifting 1kg with the Coanda Effect is about 1,4 kg/cm²

In the "Repulsine Type B" the vortex turbine has been improved for increasing the "Implosion Effect" and thus the lifting force, so you will find below a possible explanation about the working principle of "the Repulsine" type B flying saucer from Viktor Schauberger. The upper membrane is fixed and the lower rotates at high speed. On the edge rim there are special



shaped blades (boomerang shaped blades). There are 120 blades (3 degrees spaced). The enhanced vortex turbine increases significantly the "implosion" effect in the vortex chamber. This contributes to it being able to generate a stronger thrust than the centrifugal turbine used in the "**Repulsine type A**". By means of a suction screw-impeller, (which revolved from the outside towards the inside along a cycloid, spiral,

space-curve), the same type of force is generated which creates twisters, cyclones, and typhoons, through the effect of *suction*, or implosion.

In 1941 several models had been built. One of them had a diameter of 2.4 meters with a small, ultra-high-speed, electric motor. A few moments after the device was started, it climbed straight up into the air so suddenly that, unfortunately, it hit the workshop ceiling with such force that it was destroyed, and crashed to the ground in pieces...



Repulsine Type "A" left, and "B" right, side by side for comparison (click for larger view)

The implosion motor uses the *suction* forces of implosion; there is no heat barrier and no sound barrier, because with friction almost entirely lacking, no heat is generated. The air flows through the rotating air inlets, placed in the middle, and follows the gap between the double membranes (with the wave pattern). This creates a spiral contraction of the flowing medium and creates a vacuum which increases the "pull", via implosion. The enhanced vortex turbine uses two flat membranes with concentric "rills" on it. A wave pattern has been set on the upper and on the lower membrane. The upper wave is slightly out of phase with the lower wave. This is a direct application of the "Coanda" effect. The air flow passes through small cavities where the volume sometimes is larger, and sometimes smaller, due to the difference in phase relationship between the upper and the lower membrane. When the air passes different cavities it starts to pulsate. The pulsations are directly dependant on the angular speed of the discs. This "push-pull" action creates an harmonic pulsation of energy...



To the Left is another picture of an original prototype showing the major components of the "**Repulsine, type B**" engine. The air, being drawn in from the top slits, is set into a spiral vortex movement. Schauberger had claimed that once the devise was set in motion, the primary motor could be switched "off" and the forces at work would power the generator, which was housed in a central location inside the craft. For more information on this, see references in the book, "[Energy Revolution](#)", below.

How it works: *The "Repulsine"* uses a cold-water injection between the bottom plates that alternately expands and contracts the air input by the principle of "thermodynamics" (example: as can be found between a cold-water reservoir and hot desert air). In Texas, a water pump is using this exact same effect. The Texas pump has a 200-gallon tank, which has a hot air intake valve on top and periodically withdraws warm air from the surrounding atmosphere. At the tank's base, there is a single, shallow, well water pipe, which brings cold water into the tank. This effect is simple to demonstrate. The tank begins to rock on a central fulcrum and expels water from a long pipe centrifugally attached to one end of the tank. This oscillating pipe maintains a backpressure that prevents the water being pumped out from being drawn back inside the tank. Every 30 seconds, a new volume of hot external atmosphere is drawn into the tank and imploded. This causes a remarkable increase in the tanks oscillation. The oscillation is due to the intake water supply's uneven internal distribution. In effect, the tank is gravity powered.

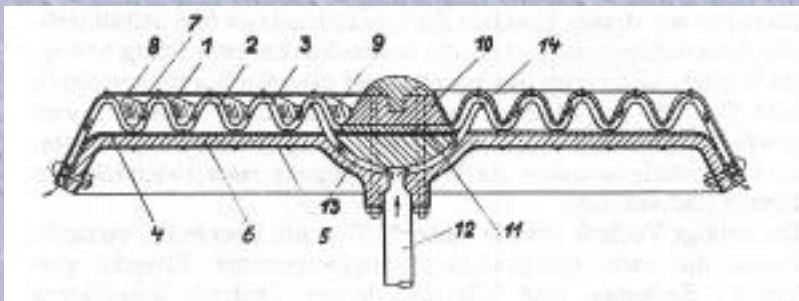

The "Repulsine" uses the same phenomena. Cold water, drawn through a base hole, is spun in between the two wavy impellers and cools the air inside the units' shell. As this partial vacuum draws in the air, it is spun into a cyclone by intake fins. After the air is cooled and humidified, still spinning, it is then

expelled from an upper turbine, which reacts with the exiting cyclone. This centrifugal air has so much angular momentum that it is able to leave the Repulsine, even against a strong internal vacuum. That is a direct analogy to the rocking tank implosion-based water pump, described above.

The hot, rising vapor, trapped in a snail-shaped chimney, is lighter than the surrounding dry air and adds to the suction on the "Repulsine'S" top. The upper turbine, spun by the exiting cyclones' action, directly drives the internal wavy vaporizing discs, which atomize the cold intake water. The electric motor (used for starting purposes) only has one purpose, and that is to spin up the vaporizer so that it properly atomizes the cold water from the inlet hose. The power source is implosion of hot, dry, desert air.

Remember that the power source is the **Thermal difference** between **cold ground water** and **hot, dry desert air**, just as is done in the implosion tank-rocking water pump from Texas. There is no mystery here. This device does nothing but convert the energy present in the combination of cold ground water with hot dry atmosphere. That is how it actually works. In many ways, it is similar to Schauberger's water turbine, which also uses a pulsed pressure reservoir. I have worked extensively on both designs. Keep in mind that without the cold-water input, the pulsating vacuum trapped inside the "Repulsine" soon diminishes and stops. There is a lot of mystery behind this device.

To quote verbatim on what Schauberger said: "***I connected the implosion motor to an outdoor water tap and it began to spin and finally took off, powered off of nothing more than ordinary, cold, tap water.***"

If you look at the "Repulsine" you will find a water pipe beneath, sticking out to the side. Schauberger was a master of water implosion technology. It is possible to "cool" air by simply pulling on a piston, but you require work to do that. At the same time, if you compressed air in a piston, it will get "hot". That requires force over a distance or mechanical work to accomplish. You see; there is no "gain"! Simply expanding a piston and contracting it (or a vortex) accomplishes little more than creating a spring. We all know springs eventually stop bouncing. Schauberger's expanding and contracting tornado also eventually ceases without an energy source. Recall the Hilsch-Rankine tube or Maxwell's demon. The tube generates spiral airflow and creates hot air in the large tube and cold air -140F in the small diameter tube. In order to accomplish this, compressed air in large volumes must be used for its ability to do work. No free ride there. It is possible to make a vertical tube howl like a banshee, but the second the

flame is removed from the tubes' inside wall - the resonance stops. Again, it requires a defined energy source. That is Viktor Schauberger's secret.

Consider this carefully: When the "rams horn arm", the **whorl-pipes** of Viktor's water turbine, approaches a valley (serrated ring at circumference of his turbine), warm chamber air is drawn inside the forming vortex pocket (that air is warm do to natural convection currents, which are of low density and hot at the top of chamber; high density, cold air at the chamber's bottom). Now here is the earth shaker. As the now warm pocket of air is drawn into the whorl-pipe tip, it approaches a "hill", and along the serrated edge, it closes the mouth of the whorl-pipe's vortex. This collapses the air bubble since the water is cold in the arm (drawn from the cold basins' bottom) and pulls the arm toward the hill by a low-pressure suction. Now, our induced vortex bubble is smaller and consists only of cold air. It must be released with the secondary spray issuing out the v-slot in the whorl-pipe's tip. We have used the mechanical energy of the condensing warm air vortex bubble. The vortex also loses cohesion because its base flow is blocked, and this further assists the removal of water ([the "Pharaoh's Pump" effect](#): this is an excellent website, by the way!).

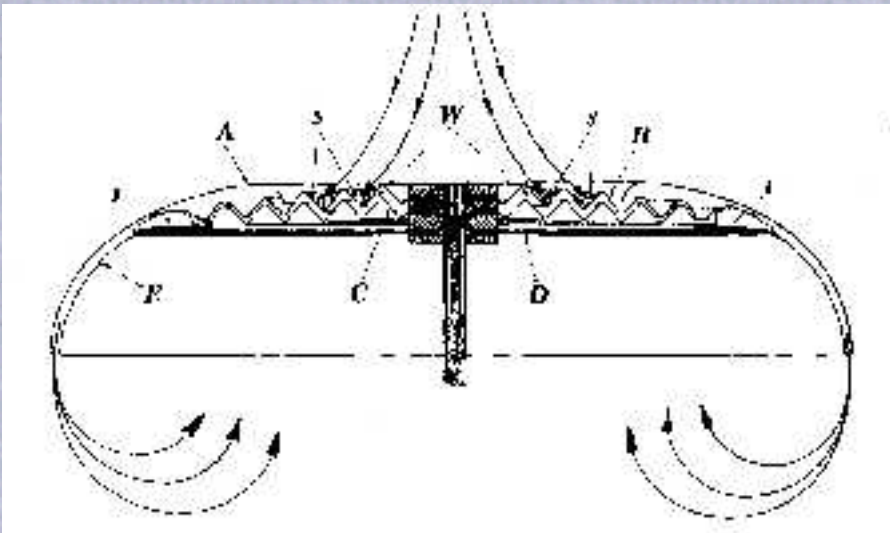

Now our whorl-pipe inside Viktor's water turbine swings to a new valley rim serration (and a new warm air pocket forms) and the implosion process starts all over again. The water turbine must absorb heat in this manner or stop spinning. The usefulness of a collapsed cooled vortex bubble is "finite". That is why Schauberger's rim is serrated. That is also why it appears to rotate in reverse (recall the egg in the bottle

experiment). So where does Viktor Schauberger get his energy? It comes from natural thermal stratification found in any sun-warmed room that sits atop cold ground water. Nature constantly restores this balance. The basin water is denser than air and very cold at the bottom do to convection cells in his basin. That is the very water we draw up to operate his implosion arms. The upper room air is warm (also due to convection currents). The heat conducts into his shell easily. That is Viktor's thermodynamic water and air secret. You can repeat the egg in the milk bottle experiment any time to see the suction involved.

Viktor's device had a diamagnetic field do to the effect. Once he noticed that when sand is dragged along a streambed, it gives off piezio electric sparks. He was a most amazing man. According to Schauberger, a water and sand "slurry" was best for this charging effect. The "Repulsine" uses a cold water pipe to cool air in its chamber. But it is not absolutely required after spin-up. The shell becomes very hot as air is compressed from induced vertical updrafts

surrounding the Repulsine. This vortex that forms above the Repulsine maintains its' suction and continues to intake large quantities of atmosphere which is then cooled at the small base intake hole's internal cyclone. In effect, the "Repulsine", like Maxwell's demon, separates the hot and cold air by conversion of external updraft momentum and uses it to draw more airflow to the "Repulsine". Sailplanes are passive convection cell user's...Viktor's marvelous machine is **active** (!) - feeding back heat to enhance its own updraft. Where does the heat come from, as it is impossible to alter natural vertical flow without generating heat? That is simple momentum conversion. ***It heats itself!***

It comes from the HILSCH-RANKINE tube effect. The shell gets very hot as the inside cools and implodes and the outside edge heats. You are actually pushing great quantities of air into the "Repulsine", as well as forming suction above it. That is known as the "firestorm" effect. If you want to generate an updraft in a chimney you must warm it. The outer shell becomes very hot. The inside center cold. This creates a resonating flow effect. If this "Repulsine" did not oscillate between high and low pressure it would not intake as much air. That air can, by centrifugal compression at the shells' rim, be directly converted into heat to maintain the effect. Look at the Hilsch-Rankine tube. It has the same exact effect. The mechanical flow of the external air (driven by natural solar convection currents) is a direct analogy to the compressed air used to drive the Hilsch-Rankine tube. **The "Repulsine" is not internally powered.** It is driven by **external flow** that is sub-ducted into its internal cyclone and generates a hot and cold region just as the Hilsch-Rankine tube does. The water and 1/20th horsepower motor is only used to start it.

I know that it is a lot to grasp. Viktor Schauberger, along with [Nikola Tesla](#), Leonardo De Vinci, Galileo, Pythagoras, and a few select others (hey...I'm allowed my favorites!), was probably one of the smartest men that ever lived. It took me months to make the smallest discoveries in relation to his work. Be mindful of what I have told you about the water turbine and "Repulsine", as it is all very easily verified. Remember, it uses an internal coolant and motor to start (1/20th horsepower) and external convection cells drawn into his base intake, which power his hot-and-cold producing, updraft-enhancing cyclone. The water turbine is powered off of the "milk bottle and the egg experiment"; warm air condensation pockets trapped inside his whorl-pipe arms. The atmosphere and convection cells from thermal density stratus - naturally present in a warm room over cold ground water - also power it, only passively.

I want to discuss the theory and the inherent hazards in building these devices. It is absolutely stupid to confine air in a chamber under centrifugal or static pressure without a certified mechanical engineer to test and verify the pressure vessel that you are experimenting with (water turbine & Repulsine). Seek out a qualified Mechanical Engineer before attempting to build one of these devices! I am certain everyone is aware of the way a "smoke ring" is created. What is a smoke ring? It is a puff of swirling vortex, created as air is forcefully driven from a hole, which creates a low-pressure torus at its center, holding the external vortex into a coherent unit. That, in effect, is a type of flywheel. In physics lectures, a professor will place a

solid wooden box on a table, and behind it, a strong rubber diaphragm. In the front and middle is an aperture that induces the smoke ring. This apparatus is found in "Physics Demonstration Experiments" volumes 1 & 2...It's a tan hardcover, large book. Another term is Hemholtz ring. This ring has very important significance to the "Repulsine", as it is yet another sign of Viktor Schauberger's genius. Now, exactly why does Viktor use those concentric rings? This has caused far too much speculation over the years. The center of Viktor's "Repulsine" is a hole at the bottom that admits the hot, rising desert air (induced from the external updraft formed around the "Repulsine" when in operation).

Seeing this base hole in a diagram, we now must understand its purpose. If we simply spun a centrifugal turbine in the base of our "Repulsine" it will heat up at the rim shell. That is do to compression of air and is agreed upon by engineers the world over. Viktor went a step further in order to remove the turbulence. He did a rather brilliant thing. He induced (by imploring all of the concentric plates) a "smoke ring" or "Hemholtz" ring. In simple terms, the air enters the "Repulsine" as a large smoke ring. We must be careful here. The end result is that that smoke ring snakes around inside the concentric plates and becomes smaller and smaller in its toroidal diameter. That is the measure of the rings smallest diameter, not the measure of the entire ring, only the thickness of the smoke ring. These rings are blown in at the center and assist the magnetic plates oscillation as they spread out. Think of a pebble thrown into a pond and disturbing the water (ripples are produced. They are actually a simple waveform effect, but we won't get into that on this page). Viktor often used natural examples.

As the smoke ring spreads out, trapped between those wavy rings (use the pebble in the pond ripple analogy) the ring becomes extremely small at its smallest diameter. **Viktor Schauberger said from the beginning: "if you want to generate heat you must compress a vortex."** I realize it is called an implosion motor. It does implode atmosphere, but the purpose is not what people think. The purpose is similar to a baseball thrown very fast. You are throwing these smoke rings at the walls of the "Repulsine". As these condensed smoke rings strike the inside of the outer shell, they deliver great heat. That heat then contributes to the external updraft, driven by suction, to the top exhaust propeller (the one with the curved blades, which in turn rotates the bottom intake smoke ring accelerator). There is nothing new here. We take in these rings of spinning air one at a time (artillery pieces produce them every day at military bases). That "wavy plate" **pushes** the ring to the outer shell and condenses it so that it heats by contracting it smaller and smaller. If we did not do this, our "Repulsine" would be less efficient. Each torus, or ring, of spinning air, is, in fact, a small flywheel containing great energy. As that "flywheel" strikes the outer shell (this is all internal physics, I am not referring to any external air flow effect), the ring is destroyed and liberates great heat. Note: In a physics lecture demonstration, there is always a doubter. It is recommended that the "Repulsine" experimenter build a simple smoke ring chamber as listed in the "Physics Demonstration Experiments" text. You will find that a smoke ring (it actually requires no smoke and is a lay term) can transport a large quantity of energy.

So the purpose of those wavy discs in the base of our "Repulsine" is, and has always been, to

accelerate intake-formed smoke rings. As they expand to the rim, they contract forcefully and gain definition. They then impact the inner wall of the outer shell, heating it enough to induce a strong external updraft, (as does a campfire). This feeds back still more energy to the upper exhaust turbine that is assisted by a rising dust-devil formed above the "Repulsine". Viktor Schauberger never used an inefficient technique. A simple centrifugal plate as is seen on standard tank-type vacuum cleaner chops the intake air into millions of pieces.

By retaining the coherence of the intake air (remember this is an inverse ring effect, as if using the physics demonstration ring box in reverse). Viktor gains the maximum energy release from his rings as they strike the inner wall and deliver their heat load as the ring is destroyed. A simple centrifugal compressor plate destroys the entering smoke ring shape. This causes turbulence and interferes with additional intake flow. Viktor takes in one vortex, or smoke ring, at a time. This orderly process insures an endless procession of rings into his implosion shell. It pulsates as each new ring is formed. The main point is that it is very **orderly**. It interacts only in the most stable way with the "wavy" or vortex-ring accelerator plates. The "wavy plates", in effect, spread and contract into a very small thickness diameter the entering ring. It looks like a wave spreading in a pond after a stone is thrown into the middle. One final time; the purpose of those discs is to take **the intake vortex rings** and **contract them** so their thickness is **reduced** and **increase** there overall diameter until they strike the shell wall and **liberate** (like a flywheel) a great deal of **heat** (that feeds the external updraft or "firestorm" effect. Thinking of a common desert dust-devil is another way of looking at it.

Let me try putting this another way. It is difficult to explain the fluid dynamics that are involved here. Viktor cooled warm air in his water turbine arm to contract the vortex bubble against a serrated "hill" on its rim. That transferred heat to the water vortex that was exiting the whorl-pipe. It is no different in the "Repulsine" case. In this case, the vortex is in the form of a **ring**, instead of a long finger, as in the water turbine spray arm (whorl-pipe tip). The vortex begins to cool **inside** the "Repulsine" and **contracts** its tornado shell around it as its thickness diameter decreases rapidly. That **increases** the speed of the ring vortex itself. This liberates a great deal of heat to the shell. I know how difficult this is to understand. If we use the brilliant research of the ["Pharaoh's Pump Group"](#), we find that water can spin around a core of air until it reaches a great depth. Then, the spinning water is destroyed, and the air inside is highly compressed. The "Pharaoh's Water Pump" surrounds air with a vortex and drops it to a lower elevation and then, collapses the water vortex around the air and liberates it as compressed air. Study this carefully. (Better yet; study the Pharaohs Pump website from the link above. Then come back to this page and continue. Note: they produce their own book...you can only get the book through their website, as it's not available from AMAZON.COM, Borders, or Barnes & Noble Books. Too bad.)

To continue; Viktor's Repulsine does the same thing. The intake smoke-ring then contracts, due to its own cooling. Place a hot smoke ring into cold air (as is found inside Viktor's implosion motor). That ring will begin to contract, but, **as it contracts**, it increases its rotation

velocity. That in turn increases its impact energy at the shell wall. Viktor intakes a large vortex ring that is composed of hot, swirling air. That ring is cooled inside the implosion motor by the contraction discs or "wavy-plate" discs. As the ring is cooled, it shrinks to its smallest diameter or thickness, which greatly increases its toroidal rotation velocity, or vortex-ring tornado velocity. Now the ring widens in its overall diameter and strikes the shell wall with great energy. Remember; velocity equates to friction. A supersonic jet has very hot skin from air friction (hundreds of degrees Fahrenheit). So Viktor's implosion motor literally intakes little ring tornadoes that cool inside his wavy disc chamber and therefore contract and spin even faster, perpendicular to their toroidal center circle line.

The Schaubberger "Repulsine" literally "**absorbs**" little baby tornado rings, and uses their **high velocity to generate internal hull friction**, which assists the external updraft. Exactly how do we make a tornado in nature? First, we bring cold air from, let's say, Canada. Then we bring up warm Gulf air from the United States. The warm Gulf air collides with the cool Canadian or Arctic air. The warm Gulf air is now "sandwiched" inside a rolling column of cold arctic air. This causes the internal warm air to contract violently as the heat exchanges from the interaction of the surrounding cold Arctic air. We now have a dangerous energy sandwich. The internal trapped Gulf warm air quickly contracts as it liberates heat to the surrounding cold Arctic air vortex (recall the water turbine arm). This greatly accelerates the vortex velocity. An analogy would be as an ice skating ballerina pulls in her arms, she spins much faster. That requires mechanical force (in her case; muscle) that force is a direct resultant of the thermo mechanical internal air contraction do to rapid cooling.

Viktor does the exact same thing in both his "Repulsine" and water turbine. In the **Implosion Motor**, it takes the form of a ring vortex spreading out to the external shell. In the water turbine, it takes the form of finger like filament that stops at the center. It is exactly what Viktor told us all along. Viktor Schaubberger paved the way as he showed us how to extract energy from a cooling vortex. It is all in the cooling vortex and its ability to be harnessed as high velocity wind friction source. The ring inside Viktor's Implosion Motor is hot on the inside and cold on the outside. That is why it contracts so violently. The vortex in the HILSCH-RANKINE TUBE is the exact opposite. The Hilsch-Rankine tube uses mechanical energy from compressed air to create one of these vortex strands. As its core expands, it cools and heat goes to the outer shell of the H-R tube do to wall friction and compression. . We use just the opposite of this effect to turn a warm air core vortex with a cold external core into compressed air as the vortex collapses. The H-R tube expands air by slowing the incoming airflow. That requires mechanical work from the compressed air source. It takes mechanical energy to pull air at its center apart by vacuum induction. The Schaubberger implosion motor vortex package is warm at its center and cold at its out side and therefore contracts forming a small ribbon of compressed air that heats the hull.

So all Viktor did was use a Hilsch-Rankine tube in **reverse!** Instead of wasting compressed air, he actually generated it. Compressed air then drives the upper exhaust turbine, and heats the hull. "Brilliant" would hardly seem an appropriate word for Schaubberger's insight and

achievement, and, it starts leading us into the energy future. There is no free energy here, only simple thermodynamics.... and hot and cold atmospheric convection flows. That is how he did it. After looking at independent sources to see if we were on the right track, Kim Zorzi sent me this update via email which confirmed our initial thoughts:

[from Kim Zorzi, Ultralight America; ULAmerica@aol.com

Hi Frank,
Hope you are doing well these days. I thought I would give you a buzz to let you know I'm still alive and kicking. I'm still working on the designs of the wave plate for my new air vehicle. I have discovered many things about the wave plates. I continue to research the chemistry aspect, and the math calculations regarding temperature and pressure in a rotational environment. I believe I have finally figured out after a year of reading why this device runs on its own power. The water injection, which causes the acceleration to increase causes an endothermic reaction to happen in between the wave plates and this endothermic reaction between the hot and cold molecules will cause an expansion of pressure to develop in this rotational vacuum celestial area which when jetted out at the outside diameter of the wave plate thru a very small orifice creates a high velocity of air. If this high velocity of air is bounced off of a small turbine blade surrounding the o.d. of the wave plate than the force applied will spin the wave plate faster, much like a squirter attached to the end of a water hose. The repulsion energy happens when the inside rotational pressure starts compressing the remaining heated air molecules into an thru such a tiny orifice (.04) clearance, then the air molecules get squashed down to their repulsion state and pass thru the orifice. The repulsion energy creates another pressurized environment inside the accelerator housing (around 32 atm) and when jetted out over the bowl creates the Coanda effect. But the air molecule being emitted is a cross between hydrogen and helium. This molecule when ejected at a swirling velocity out of the accelerator housing encircles the vehicle. This very light air molecule has an upward velocity of 3700 mph once released. This is what causes the cyclonic reaction to happen above the vehicle in which it is sucked up in its wake. The heavy side of this is that this light air molecule is very explosive and if you make a high column of air a mile high of this molecule and it is touched off by a spark it could cause a horrific explosion.]

How to build a Schauberger Repulsine:

Before we begin with construction of the Repulsine, this is what can happen if careful research and proper assembly, along with using quality materials for construction **is not** followed and adhered to:

- One: the “Repulsine” will shred its upper power turbine! That turbine spins at a very high rpm and can, if formed from cast metal, shatter without warning.
- Two: the internal thermal zone separator (wavy discs) and mechanical fluid work transmitter can shatter, as it is hollow (I will explain) and flexible and is also not capable of withstanding high centrifugal stress do to its “perforated” construction and wavy design. It generally will shatter first.
- Three: the casing of the “Repulsine” is formed of copper in one device (although steel can be used) as this is for heat conduction. Copper is a brittle metal under repeated

stress and can crack easily. Once again, shards will be expelled onto any unprepared researcher.

- Four: it is capable of high temperature's (I will explain). It can scorch and burn its surroundings or a careless researcher. That temperature can easily reach 300 to 500 degrees F.
- Five: it can explode if its internal vortex is suddenly quenched, venting super heated air onto any nearby observers.
- Six: it must be grounded. It is best operated over hot pavement (I will explain). There is no simple way to describe its power level. It is cyclic and similar to a child's top being spun faster and faster. It can, by a very strong suction force (as it sits in the middle of a much larger external vortex) be wrenched from the ground.
- Seven: it can effect the external environment. It is highly recommended any researcher using it should precede to an area with no air or automobile traffic.
- Eight: it can set fire to any dry brush present. It must be operated in a rock quarry or concrete industrial area for maximum fire safety with a fire extinguisher standing by.
- Nine: it is difficult to gain the approval of a mechanical engineer with an unproved technology; however, he or she can still verify that every precaution has been taken. The vessel is subject to high internal winds approaching 100 to 300 mph; never underestimate the harm that wind can do. That wind can amount to several static pounds pressure per square inch. It is the escaping wind that is most dangerous.
- Ten: as air is ionized around the "Repulsine", it can produce dangerous electrical phenomena. That is due to dust particle charging. Anytime air passes a chamber that is not grounded, at high speed it can induce charged particles! Be prepared for static electric build up if operating in a dry environment. See below for further information regarding safety issues.

A small "Repulsine" can easily produce 10 to 25 horsepower; a large one, in the ten to twenty foot diameter ranges, can produce well into the thousands of horsepower. This is due to its power concentrating effect. It is in a category of windmills known as dynamic flow enhancers. That is to say its passive wind flow rating is small and no more than any similar Darrius or Savonious type. However, once the work function has begun, it can concentrate external flow from 2 times, up to 10 times. ***That is, it will generate the equivalent power level of a machine ten times its own size.*** This is similar to windmills of the "diffusion cone" type. That refers specifically to a windmill that has a large external diffuser or cone that assists in flow pressure concentration allowing even a small turbine to generate far more than its diameter is capable of without the added diffusion cone to create a down wind low pressure pocket.

The "Repulsine" consists of a few major parts. It has a top cone or chimney that, like the rest of the shell, must be constructed of heat conductive metal. Viktor wanted this top cone to be shaped like an elongated snail-shell. This is so external wind, in the form of a dust-devil, can enter the cone and assist the upper drive turbine's rotation. I have found it best to use

materials similar to the steel chimney pipes found in wood stove connection joints (a light steel sheet formed into a cone and riveted so that there is no turbulence on the inside of this upper chimney cone). That is the simplest part to fabricate. The taller it is; the better. It should have at least twice to five times the height of the primary plenum chamber; its upper outlet diameter is still debatable. I recommend looking at Schauberger's water turbine arms and using that as a conical ratio. If a small aperture overly restricts the upper chimney, the flow will quench. If an oversized exit hole is used, the flow will receive too much horizontal ground wind turbulence backflow. The dynamics problem of the horizontal flow as it interferes with the vertical convection flow produced cannot be underestimated. That is the bane of all wind generator engineers who have attempted to produce energy by concentrating convection flow. That is, the horizontal wind will antagonize your "Repulsine" unless it has its upper cone intake aperture or snail-shell mouth directly pointed into the apparent horizontal wind. Wind is variable; it can change direction without warning, so keeping the upper snail-shell pointed can be a frustrating chore. You cannot place a guidance fin to keep the snail-shell mouth pointed, since that will break up the induced flow of the external dust-devil vortex.

Viktor simply ignored the snail-shell all together and only punched a few inlet and outlet holes in a simple conic upper chimney shell. That is not to say it is *un-important*. He simply could not get the correct shape fabricated. The upper chimney focuses the exhaust vortex leaving the "Repulsine" drive turbine. Now you have the fabrication of the upper drive turbine. That turbine must be mounted on a shaft (if using a 22-inch unit) capable of at least 10 horsepower minimal load. Shafts of this type are found on all small engines in that horsepower range. One-inch diameter shafts will ensure maximum safety. Obviously, the bearing must be of a reliable type. I recommend from personal experience the bearings used in racing go-carts wheel shafts. They have a 3-bolt mounting cup, and are very reliable.

The upper plate can be found on old centrifugal blowers. Yes, Schauberger's design used multiple curves, but that is not set in stone. The cooling fins found on a two-cycle motor or lawn mower head can be substituted in a pinch. The plate from the centrifugal blower of a ruined engine can be used for the exhaust drive turbine. The air coming out is cyclonic so the plate is used in a reversed fin rotation. That is fairly obvious to any one building one...this plate cannot be constructed from plastics. It will melt! I realize plastic is safer and easier to fabricate however it is also worthless in a "Repulsine" exhaust turbine. Next, you require the shell. That shell is fabricated from a 22-inch diameter Barbecue Kettle lid piece. It has a flat region that is cut out for the upper exhaust hole. The exact plenum exhaust hole size on a unit is critical. Once again, if it is too large, the shell heat won't build to a high temperature. Too small, and it will vent waste centrifugal air poorly and shut down the unit. Use Viktor's photos. My ideal exhaust hole is 12 inches in diameter with a 22-inch plenum shell. I am still experimenting on the best diameter exhaust turbine.

The "Repulsine" has need of two active parts; the upper exhaust turbine (or reversed centrifuge blower plate) and the inner wavy discs (that use the mechanical work from the upper turbine). These discs are not easy to fabricate. The best material I can find is used in fireplace

screening and perforated. You must locate a source of perforated steel. That perforation is to allow airflow through the wavy discs, which also prevents back conduction of heat from the outer shell or rim region (I will explain). It will be found that Hammel, used a perforated metal cone on his devices. That is the type of shell you are after. Perforating a steel sheet of that thickness with thousands of holes is difficult and imprecise. If you place too many perforations in one area, the disc may shatter!

Why do it at all? Recall that I spoke of the H-R tube. Those wavy discs serve to conduct vortex strands and transmit mechanical energy to the internal plenum chamber vortex from the upper exhaust turbine. They cannot be underestimated. They **are** the “**Repulsine**”...Think of the drive exhaust turbine as a simple windmill. Updrafts and convection currents power it. It is also driven off of any horizontal flow that is swirled into the upper chimney shell snail shell mouth. **That is all it does!** It uses waste exhaust to spin that is given maximum pressure advantage from the suction above it in the upper chimney shell vortex. **There are three vortexes at work here!**

- One, is the external shell heat vortex or outer dust-devil,
- Two, is the vortex in the upper snail shaped chimney shell,
- Three, is the mechanical work vortex inside the “Repulsine” plenum or H-R tube vortex,

The novice experimenter should examine carefully the work done by vortex Wind Engineers on the web. The entire upper part of the unit is already in use at many wind turbine-generating sites! Assuming you have successfully fabricated the exhaust turbine and mounted it in a typical tri-arm mount, flush with your plenum shell, and mounted the two opposed perforated wavy discs on the long drive shaft, you now require a base shell. This shell must be as strong or stronger than the upper shell. It can be flat and still function. If it is flat steel it must be reinforced. It is always best to use shaped steel that is self-integrated structurally due to its own 3-dimensional form. For example, it can also have a wave ring shape. That is far more rigid than a simple flat piece. That is yet another reason the wavy discs are curved so they are rigid when the “Repulsine” tilts or lifts.

This is then bolted and sealed to the upper shell. This is critical. The outer rim is subject to great pressure and heat. The bottom hole is smaller than the exhaust hole, however the relative surface area is comparable. This is because a great deal of the upper exhaust turbine plate is sealed with only a small exit region open at its circumference. The bottom shaft bearing can be tri-arm mounted as well. These hole-sizes are critical. If the bottom axle area intake hole is too small, it will not take in enough air! The exact diameter, as compared to the upper exhaust hole is still a matter of experimentation. It is between 4 and 6 inches in diameter. In other words, its diameter in surface area approximates the exhaust outlet surface area. The entire assembly is best placed on yet another Barbecue Kettle piece - the bottom hemisphere. In this use, it is placed round side up (that is its rim on the ground). Several metal posts now go to your bottom plenum. The plenum or H-R work chamber is mounted 6 to 12 inches above the inverted kettle hemisphere. Those posts will later have metal fins on them,

which will be twisted to guide air into the single intake hole, placed concentric with the drive shaft.

Now, with all in place, you can do a first spin test. Instead of an attached motor, you can use the pressure exhaust of a large tank-type vacuum cleaner. It requires precise aim. Place the hose near the exhaust turbine and push air against the curved blades the same direction the air is meant to leave the plenum chamber. This is a simple reaction effect. The snail-shell hole is more than large enough for you to place the start-up air jet. Recall that model pulsejets were actually started with a bicycle pump. Now your unit is spinning! What happens next? Usually, very little will happen. It will spin of course, but, until the exact exhaust ratio and intake ratio is found, you can expect no miracles. The bearing races must be low-friction units. If you do it correctly, the unit will begin to heat up at its plenum shell circumference. Why (?) - because the internal wavy perforated discs and compressions on the shell rim are spinning air centrifugally. That can be seen directly by touching the top of any large-tank vacuum cleaner with a metal flange head. In fact all centrifugal air compressors or high pressure fans heat in this manner. Inside the plenum, the air is being separated into a center, or axle region, cold-zone and outer rim region hot-zone. Mechanical work from the upper exhaust disc is being used to separate these temperature regions. This effect is no different than is seen on the H-R tube! The only difference is that air is being spun on the unit by frictional interaction with the wavy disc set. In the H-R tube, it is from the mechanical energy, released as compressed air, and is swirled into a vortex tube. The exact same thermal separation occurs. The inner region is cold, and outer region is hot. That heat now contributes to a rising updraft vortex about the "Repulsine". Recall in a calorimeter experiment, paddles are spun to heat water in a closed shell . One experiment is to then spray water at various temperatures into the shell. If it is done properly, it will assist in imploding the center cold air mass and greatly increasing the RPM. of the turbine. This is a science experiment of a lifetime.

Why does it work? As the work being done on the "Repulsine" internal plenum increases from the exhaust turbine drive shaft, the steel shell reaches a critical temperature level. At that point the rim air approaches several hundred degrees. The wavy discs prevent heat from easily moving from the rim to the center (that is one reason they are perforated and cannot be solid). The plenum will begin to alternately heat and cool as new air is drawn in at its base. If its core air trapped in between the wavy discs is cooled, the plenum velocity will increase. If it is heated by intake air, the velocity will slow. This effect is resonant and typical of the "Repulsine" operation. It is very hard to explain. Viktor claims, that any time you allow the core air of his Repulsine to heat and expand, it pulls the internal vortex wider apart! Next, as you intake cooler air, it snaps back together again. ***This is a phenomenon of thermo-mechanical resonance. [Tesla coils](#) use the very same principle.***

The point is that your plenum will be driven off of [induced external updrafts](#) (as if a campfire) and off of a **resonance** caused by changes in the core vortex temperature! That is to say, the plenum chamber is like a child's top. Any temperature change will cause the internal vortex (a

vertical axis vortex centered about the drive axle) to expand and contract. The temperature changes **must** work in resonant fashion. Think of the child's top being spun faster and faster, as they plunge its push rod up and down. This resonant expanding and contracting vortex bounces off the wavy rings much as ball bounces on a floor. Each time a little more energy is added. It is like stretching and contracting a rubber band around your fingers. When thermal mechanical vortex resonance is achieved, the implosion motor takes off. This is not an out-dated centrifugal air compressor. It is a chamber where any intake air is being converted into rotary motion. As the air vortex enlarges, it strikes the rim and cools. This causes it to bounce and return like a wave, to the center of the chamber (much like an echo reflecting off a hard surface). This compresses the center cold air and heats it, causing the wave front to once more expand.

That is why the wavy perforated discs are so important. They guide this echoing vortex band as it bounces from the rim to center and back again. To see what Schauberger saw, go to a circular water bath or tank (it must be a perfect circle). Put a Styrofoam disc at its center with a stick attached. Start to resonantly plunge the disk up and down. If you time it right, the wave crest will work with your plunges in harmony, as it bounces off the tank's wall. This is exactly why those disks are wavy and perforated. They allow the vortex bounces to build up energy. Yes, you can argue that it wastes power. Actually it does not. The heat leaving the rim feeds back into the exhaust turbine updraft. You are amplifying this echo effect. Now the skeptic will begin to squirm in their seat. What good is this resonance effect? Sure, a Tesla coil makes a big spark, but that uses up electrical power even at high Q.

What makes a two-cycle motorcycle tail pipe exhaust expansion chamber work? Echo! That is correct. The principle that helps back pressure a two-cycle motorcycle engine is the exact same principle that feeds back energy in a Schauberger "Repulsine" implosion motor. It makes no difference. We can get mechanical work either way! **A Sterling engine obtains mechanical work on both its cold cycle and hot cycle!** We now have two defined reservoirs; a **cold rim reservoir** and a **hot central intake reservoir**. These reservoirs are maintained by external wind and sunlight. **This is not a guess; it is a fact!** A Stirling engine uses a displacer to shuttle an air mass between a hot and cold reservoir! Go to the fine Japanese Stirling engine pages found all over the web and you will soon understand this principle.

In the "Repulsine", it is accomplished by the natural vortex echo inside of the chamber. This echo builds up our RPM. That is why the wavy discs are perforated. They must help spin the vortex but never stop its wave front echo. Think of that as a natural air displacer. Striking the rim cools the vortex and reaching the center heats it. The center bottom is hot from intake air ramming. Think of it this way before you stop reading this material. The echo bounce places our vortex over the center and then the rim region. That takes the place of the Stirling engine displacer. The vortex acts like a flywheel that stores the bounce energy. In effect, it is a simple Stirling engine hybrid that uses the expanding and contracting vortex as both a **piston and a displacer, at the same time.**

This is not difficult to understand. The Schauberger “Repulsine” is a new class of Stirling, atmospheric-feedback, hot-air motor. Schauberger’s genius removed the complex **piston and displacer**. They are replaced by a bouncing and expanding vortex and contracting vortex ring. If the reader takes away nothing more about the “Repulsine”, consider the following. IT is **not** a centrifugal air compressor. ***It is a new class of Stirling hot air engine, that converts a captive vortex into a piston and displacer that therefore shuttles between a hot center region, and a cold outer shell.*** This vortex also forms the Stirling Engine hybrid’s flywheel. In one simple gesture, Viktor removed the flywheel - the displacer and the piston - of a Stirling hot air engine - its closest thermo-mechanical cousin. By combining all of these elements, he simplified the Stirling engine, and, allowed it to directly feed back energy to an updraft. ***In other words, its own waste heat assists in increasing a natural external flow. No Stirling engine does that!***

A final purpose of the wavy internal discs is to help “bounce” the vortex. It is similar to the 90-degree phase drive rod that activates the displacer. It forces the vortex wall back out to the rim. I realize that I said the rim is hot and it is. That is because it is constantly relieving itself of heat from the internal bouncing vortex. It is also cooled by the swirling external vortex. Without that, it is no longer a useful reservoir. In effect we have discovered a dynamic feedback Stirling Engine suited to extracting energy from a stationary external tornadic convection cell. This is not free energy...but I feel it is neglected physics. Only time and a little faith in Schauberger’s genius and commitment to relieving the suffering of mankind will tell.

In the “Phillips Technical Review Notes” we found references to an **Air Core Betatron** containing only a few kilograms of active magnetic flux material. That is to say the “Phillips engineers” had found a way to avoid the entire heavy iron superstructure used on a Betatron. It relied instead, ***like a Tesla coil, on resonance in heavy cables.*** To add, therefore to the list of things to avoid when constructing a “Repulsine”, I must now in all fairness add the “Air Core Betatron” effect. This means very simply, your “Repulsine” is capable of hard X-ray production from an internal current imploded with the thermo-mechanical rim resonance vortex bounce. ***To put it simply; the Repulsine at full resonance is a radiation source.*** It is possible that 50 thousand to 10 million electron volt-level radiation by-products, in the form of hard X-rays, will be present during operation. Any time you contract a charged electron cloud so that its magnetic field is cut, you can, and will accelerate electrons in the defined nature of a Betatron Particle Accelerator! It can and will emit high-energy particle radiation of the class known as “High Energy Electrons” and Hard X-rays. The Phillips’ “Air Core Betatron” proves a large ferromagnetic induction mass is not required for electron volt energy levels up to 9 MEV. Prolonged X-ray exposure is a certified tissue destroying process. ***For those “would’be” Nuclear Physicists out there, any doubts that the Repulsine is capable of Betatron particle acceleration will be quashed after reading about the “Phillips T.R. papers on their 9 MEV “Air Core Betatron””.***

The final piece of the puzzle; The "Repulsine's" rim is resonantly cooled by thermally induced downdraft feedback, as the internal plenum flow expands for its re-coil or implosion echo. It is a surface effect. Hot internal centrifugal air induces a cold downdraft pulse that is in effect the capacitive analogy to our thermo-mechanical vortex resonance, taking place in the unit. Hot always attracts cold ...remember that! ***The "Repulsine" is unpredictable and dangerous, and, in an evacuated condition, is capable of Hard X-ray production. It is NOT a toy. It is best left in the hands of certified engineers and physicists!***

My compliments and thanks to Mr. Robert (James) Bailey for his support, research data, notes and insight regarding construction of the working Repulsine model. The information that Mr. Bailey provided was absolutely invaluable in the compiling and research regarding construction and operation of a true Schaubberger Repulsine. A heart felt "thank you" from all of us at ITP. Also my unending respect and gratitude to Mr. Callum Coats, without whose work none of this website (or anything regarding Schaubberger!) would be possible.

NOTE: To any and all serious investors and investment groups - International Turbine And Power, LLC, and individually, Frank Germano and Martin Dorantes, has the capabilities to design working prototypes of the Repulsine. We would gladly welcome discussing any opportunity for joint venture ideas or other applications via providing the necessary funding.

O.k., I am off of the soapbox and on to some more of Schaubberger's inventions...



Viktor Schaubberger's "Atom Transforming Machine:

Amongst the vast amount of research notes written by this man, of the many telling accounts of the huge amounts of power locked inside ordinary air and water, this account shows too the amount of respect he had for those impressive latent powers. Viktor Schaubberger next to his invention, left.

The Atom Transforming Machine - This note is taken from a special edition of "*Mensch und Technik*" vol 2 (1993) sec. 7.7.7 of notes from 15th July 1936 about Schaubberger's work at the time:

"Today we began to assemble the atom-transforming machine. Tomorrow or the day after it will run for the first time. Simple and true, that is the impression one gets when observing it. Unfortunately, in its present state we

cannot make the upper part of the machine fully operational. The danger is too great. I cannot risk the lives of my co-workers. Fully operational, the machine must be remote-controlled, for either a violent thunderstorm or a cyclone will develop. If the organic **H** discharges itself downwards, then there is a short-circuit - a thunderstorm, whereas an upward discharge of **H** produces the celestial electromagnet, which is actuated at about 40,000 milli-amps, and with it the charging up of the celestial Plus + Minus, i.e. the cyclone. The physicist Renault produced a short-circuit, which incinerated him and his colleague in a matter of seconds. Perish the thought that it should first ignite on the **TRANSVERSE** axis ! It entirely depends on where the **H** discharges. On the transverse or vertical axis ? This determines the stronger pole, for here too a bipolarity is involved."

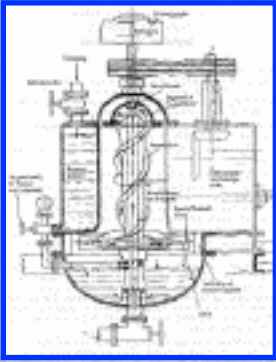

The French physicist **Gerard Renault** [c.1926] (operating under Viktor Schauberger's theories) had already occupied himself with the problem of obtaining electricity from the air. In his laboratory in Grenoble, he worked night and day on his invention, and even the scant information that emerged publicly, created a sensation in scientific circles. One day, a machine stood in his workshop which was held to be a wonder. Day after day its wheels turned without any observer being able to determine whence the driving force originated. Neither steam, nor combustion gases, nor electrical motive forces could be detected. The machine stood on its base, completely insulated from the ground, and ran independently like a *perpetuum mobile*. For a while Renault enjoyed the general wonderment, and then one day he said, **"This machine is, in fact, driven by electricity, but with electricity from the air ! I have solved the problem. With its practical application, in a few years we shall achieve a paradise on Earth."** Viktor Schauberger with the machine (operational) , with the top cover removed - left.

The French Academy requested Renault to come to Paris so that he could demonstrate his invention there. The inventor agreed, hastening to the capital with his assistant, setting up his machine in the experiment theatre. Just before the beginning of the demonstration, he wanted to explain how it worked. His assistant was present. Suddenly there was a tremendous explosion, flames shot out of the doors and windows, and once the fire brigade had succeeded in extinguishing the fire, the machine was a heap of wreckage. Renault and his assistant died in the explosion.

(Extracted from the periodical *Der Weg* (7/11/1946, 1st year, no 48, p12) (and reprinted in "The Energy Evolution" edited by Callum Coats (2000) p125). My take on the story: Can anyone spell **"Sabotage"**?! FDG

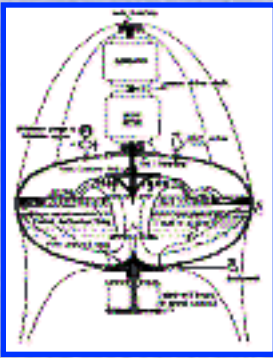

The "Implosion Machine", or "Water Tornado", home-power generator as illustrated.

This is a machine which Viktor Schauberger constructed to generate electricity. Now, when I say electricity, I should say free, over-abundant, electricity. You see, the machine, once started, **generates more electricity than it uses**...don't lose interest on me because of the "free energy" implications...read on. It is similar in concept to the "Klimator", which was

another machine, primarily designed to produce either "heat" or "cold" temperatures - a pre-modern air conditioner, of sorts. This engine is something, the likes of which, I have never seen. I can't wait to get the opportunity to actually BUILD this machine and fully test it out. Even if the claims are only partially true...it would mean such an advance in engine technology that its worth could not even be estimated. Why hasn't this machine been built and put into use? [Click here for a great link and find out.](#)

A small electric motor drives a conical center piece which has a large water inlet, and forces the water out through several spiral arms, shown below, which Viktor called - "Whorl-Pipes".

Whorl-Pipes:

Every whorl pipe is a tornado, a vortex. The flow-through material creates a space-spiral.

([Patent information - click here](#)) From the starting point, movement is both inwards and downwards at the same time. The whorl pipe must be cone-shaped on its longitudinal axis. In experiments with cylindrical pipes, few noteworthy effects were achieved. In addition, there is a third direction of movement, which seems to be most important; it is a rotation about itself, which in regard to the electrons in atoms, we call 'spin'. As the device spins a centrifugal force raises the water level .

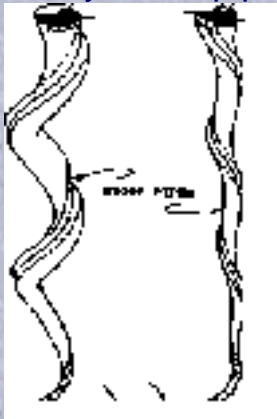

The acceleration of the in-rollment of the flow-through

material depends on four factors: 1.) the length of the pipe (whorl-pipes), 2.) the size of the intake cross-section in relation to the outlet nozzles, 3.) the rotational velocity of the rotor, and 4.) the diameter of the conical rotor, because it is upon this, that the centrifugal force depends. The arms nearly reach to the outer limits of containment vessel and a recoil action is produced when the water sprayed out comes into contact with a wavy or rippled steel ring. To begin with, the drive motor is powered from any available current source, in order to set the rotor in motion. When the rotor is in motion, it produces more power than the drive motor requires, and the electricity from the generator, in excess, can be ducted off for other purposes. **According to estimates, the proportion is in the ratio of 1:9, namely, 1/10th of the output for running the drive motor, and 9/10ths as surplus power. The "Implosion Machine" is therefore, more than, or quite literally - a form of, "perpetual motion".**

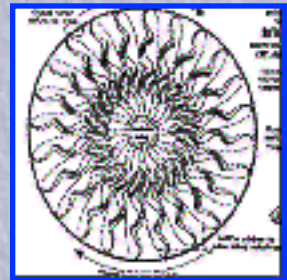

Special Jet Nozzles: the tips of the whorl-pipes:

The centrifugal force in the spiral arms creates a reduction in pressure on bottom part, and this leads to great efficiency. As the device spins, a centrifugal force raises the water level. The spiral arms were said to look like a wild animals antlers (from the Kudu antelope; spiral "horns", thick at the base and coming to a thinner point at each end.) When the machine was running the generator was then switched on-line. The tips of the "Whorl-Pipes" are illustrated..

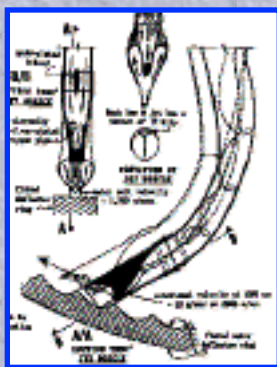

A Vortex movement was created inside of each nozzle, and the velocity on exit approached 2,500 psi, at 1280 meters per second.

The Water Tornado machine could produce a Mega watt of electricity. James Yen, working for the American company - "Grumman Aerospace", estimates that a turbine of only **six feet** in diameter could produce a mega watt of electricity. The concrete silo as illustrated, has an open top and is open to one side. A electric motor could be switched on to begin the whirlwind effect, and, once the "swirling" (vortex) action had begun the motor could be reduced in speed or taken off-line, entirely.

The air flow enters from the top of the tower and the air is forced to "whirl" because of the way the tower is constructed. When the air flow is whirling, a reduction in air pressure is caused. Air coming from the bottom is drawn into the vacuum, and, in doing so, drives an air turbine generator. Experiments with wind tunnels seem to confirm this idea will perform as expected. We may yet get to see a spiral action in generation of our power needs *if* the scientific establishment is ready to seriously look at it. I'm trying to convince "big business" to fund the research...it just takes time, and constant persuasion. Here's the break-down of the operation of the "Implosion Machine" as far as I can relate:

1.) As connected to the suction pipe, every whorl-pipe is a siphon. As a fall-pipe, the whorl-pipe is longer that the vertical suction-pipe. Its exit nozzles are at the same height as the lower end of the suction-pipe. Only slight impulse is therefore required to trigger the flow of water.

2.) As soon as the rotor reaches top speed, the water is centrifuged against a fluted outer wall with enormous force. As it impacts a dense electrical force-field evolves, in which, the weight of the water is neutralized. This electric charge can be increased by the rotor's rate of rotation. The water rises, with out being lifted, in the suction-pipe and passes into the whorl-pipes from the collector. The fall-weight is the impulse that enables the ducting off of "surplus" power. From time to time, the water should be changed. The electric charge also must be ducted away, otherwise, it can act as a "brake" in front of the water nozzles.

3.) A further gain in power results from the removal of frictional losses in the whorl-pipes. The effect of these pipes is to produce a rolling, inward vortex, spiraling action that reduces

virtually all resistance to the flow inside of these pipes.

4.) Due to the rapid rotation of the rotor, centrifugal forces arise. The accelerated water in the whorl-pipes is thrust against the fluted outer wall of the machine. The ends of the whorl-pipes are curved in the opposite direction to the actual direction of rotation. A recoil is created, similar to that in the "Abundance-Producing Wheel" (another of Schauberger's inventions). This recoil develops energies similar to those found on tornados. I should note, cooling takes place inside of the whorl-pipes, and the "cool eye" of the machine sucks up water, quite the same way as a natural tornado "sucks" up anything in its path.

How about USES for this amazing machine...boy, that's a tough one, huh! Here ya go...

1.) The generation of **FREE Energy**, in any quantity, whereby the water used to fill is converted into "noble water" (pure, natural, healthy drinking water, full of extraordinary properties)

2.) As a generator for the achievement of manifold increase in growth. If embedded in the ground, the energetically charged water radiates growth-enhancing forces down into the earth

3.) For the propulsion of aircraft, which can never malfunction and crash. (See [Viktor Schauberger, page four](#) - the next page on your journey - for a fully descriptive explanation and diagrams of the proposed craft).

Clean Air Machine

This is another spiral device but uses the shape of an oval egg. "Soilt" air is introduced from the side and combined with water that the reduced pressure draws from the bottom, via a tube . The spiral flow in the tube cleans the air with water which flows back to the base. Clean air then exits from the top. Again, click on any of the images for the "full-size" view. This image was sent via email, and I have no clue as to who originally did the wonderful artwork - thank you.

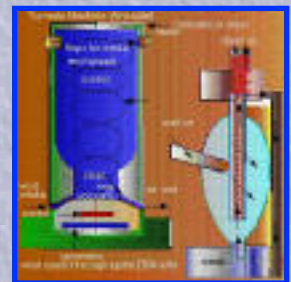

[Viktor Schauberger's British Patent: Water Conduit.](#)

Viktor Schauberger's Biological Submarine - originally appearing in "KeelyNet" 03/25/02

From Journal Of Borderland Research - Sep/Oct 1990, page 9.

The biological submarine once had the attention of the German War Lords, but Viktor

Schauberger made it look as though it were not very useful, as in his opinion, bio-technology is for supporting progress and not for destruction. This submarine idea was taken from the observation of fish, especially of trout, which can stand motionless in a flowing stream, just by taking water in and out.

This process has two functions, first it creates a vacuum in front of the mouth into which the fish gets sucked, and at the same time provides food, as the water contains all that the fish needs. While the food goes into the digestive system, the water is forced through the fan-like structure of the gills, which not only absorb the oxygen needed, but also push the water backwards. This specially compressed water does not mingle right away with the rest, it glides along the conical body like a wedge and shoves it forward. In addition, on the scales it forms little whirls which enhance the push further.

However, Viktor Schauberger was not the sole observer of this phenomenon. Before him others not only formed the same idea but even constructed prototypes with some results. One inventor, A. Borner, came to the conclusion that the speedy motion of the fish is relative to the size of its gills. He constructed a boat with a precise opening in its bow, where a turbine sucked in water like a fish, and pushed it out through slit-like exit ports in such a way that it glided along the hull like a sheet, not only separating it from the friction of the outside water, but also giving it an additional push forward.

Further, he applied skin depressions like sharks have on his ship's hull, presuming that they cause small swirls, and so increased the forward motion. Borner even incorporated the slippery skin layer that fish have by applying oil to the hull to reduce friction. He hoped all this would bring a 60-80% reduction in fuel. Indeed, experiments with his boat FORELLE, meaning 'trout', achieved twice the speed, while still using the same amount of fuel. Apparently, Borner did not know about the spiral-vortex, which is an invention of Viktor Schauberger. If properly applied, it will not only increase speed, but also reduce fuel consumption to a minimum!

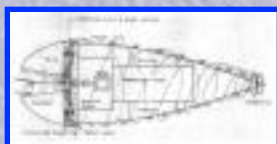

The drawing (left) by **Dipl. Ing. Walter Schauberger**, Viktor's son, shows such a submarine. His bio-technical submarine has a moveable bow, which gives the boat the flexibility fish have. The conical and rifled (rippled) water-intake permits a variable step-up, creating a strong torque on the water, which, after entering the implosion turbine, will be intensified to such a pitch, that now its recoil (resonance) is driving it instead of the motor, as bio-technical applications always have a pull and push action. Such a turbine consists of tapered-down pipes with inside rifling which are bent into spirals. Such FREE ENERGY is not a question of time, rather the will to USE IT, as it already exists, giving us a chance to move on water, under it and in the air using only a fraction of the energy we use today! Click thumbnail to enlarge image.

We've taken the time to "modernize", if you will, Viktor's craft, and come up with both the Bio-Technical Submarine, and the Bio-Airship - click the thumbnail images, below for a larger view. Both operate on the same principals set forth in Viktor's patent - with the exception of using our Bladeless Disk systems as the propulsion: renderings

provided by our friend, Frank Chase.

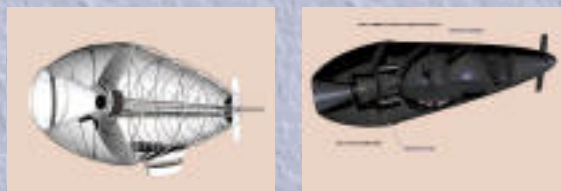

Don't even begin to think that that's all of the inventions...how about the "Air Turbine", the "Ennoblement of Water", "Gasoline from Water", "The Repulsator", the "Klimator", the "Trout Motor, or Suction Turbine"...hey, what would it be if I didn't let you explore these fantastic inventions on your own...so, pick up some of the books listed in the "Tesla & Schauberger on-line bookstore", below. For the inventions themselves... "Energy Evolution", is the best one. For overall knowledge, try "Living Energies". Again, many thanks to Callum Coats for his dedication and brilliance, and fantastic series of books on Viktor Schauberger. The journey of discovery is far from over. Click the link below to continue to PAGE FOUR. **If you would like to join a discussion list focused solely on Viktor Schauberger, you can join the list below. As always, if you have developed an interest in learning more about Viktor Schauberger, the books are listed, below, as well. Just click on the "buy from Amazon.com" link provided. FDG.**

[Let's continue to the next page... Viktor Schauberger; PAGE FOUR](#)

Subscribe to [viktorschaubergergroup](#)

Powered by [groups.yahoo.com](#)

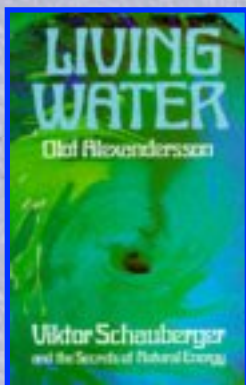

The original translation of Viktor Schauberger's work, "[Living Water](#)", by Olof Alexanderrson...start here, and get each one in order. This is an excellent, brief introduction to the thought of Viktor Schauberger, and I hope it inspires works which are more complete. Callum Coates' books reach in this direction, but what is really needed are more people to read these books, synthesize their information, and come up with new and original books which take us further into depth in these areas. This will probably involve synthesizing the work of Schauberger, Grandier, Bienveniste, and others. An understanding of Schauberger is very important for those attempting to reconstruct an Indigenous European Perspective. Schauberger has the elements of a modern water shaman, and his shamanic / intuitive techniques of letting his body float with the water should be closely

correlated with what Hans Peter Duerr has to say about "out of body" experience in his tome "Dreamtime". Although Schauberger lived in the 20th Century, his perspective allows us to imagine back what earlier indigenous practitioners may have been like. The Colonial, Imperialist Europe is only one side of the coin of Europe. We must also include the suppressed indigenous, pagan, and green sides. Significantly, the Inquisition represents a watershed in European history where a great deal of the indigenous healers and theorists were wiped out in holocaust proportions. An understanding of Schauberger, coupled with an appreciation of Steiner, Hildegard of Bingen, Hans Peter Duerr, and others, will allow us to reconstruct what a noncolonial, nonimperialist Europe was like. Understanding water's nature is essential in this regard, for water forms the basis of our understandings of flow. Furthermore, understanding water's energetic qualities will help us understand how it interacts with the body. Traditional Chinese Medicine, for example, would benefit from an accurate and holistic understanding of water's qualities. In short, this book is an excellent appetizer.

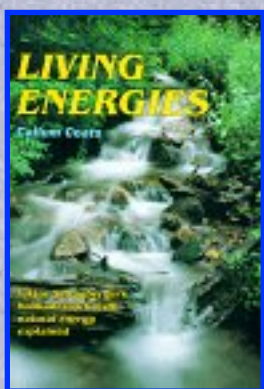

The book that started it all...[Living Energies](#), Callum Coats first Viktor Schauberger book. If you only buy one book, this would be the one to get. Fantastic. Living Energies, May 23, 2001

Reviewer: Frank D Germano, from Tafton, PA United States: This book started it all! Callum Coats basically brought to "light" the resurgence of interest in Viktor Schauberger's theories. This is truly a brilliant work. Water as a carrier of vital energy information, trees as bio-condensers of energy between the deep earth and the sun, how self-cleansing rivers nourish the landscape, how the future of the earth depends on the replanting of natural forests, revolutionary agricultural implements, free energy heater-coolers, jet engines and gravity defying machines invented by Schauberger in the 30's and 40's, home power generators...it's pretty much all here. It was a hard book for me to put down once I started reading, and I go back to it continually for reference. This book pretty much sums up Schauberger's work, which Coats then compartmentalized and expanded in the "Eco-Technology" series with four other books. I would highly advise getting this book, first, and reading it thoroughly, before moving on to the series, as it is a fascinating preface into discovering who Viktor Schauberger WAS, and learning just how far-reaching his theories were, and applicable to us, today. FDG.

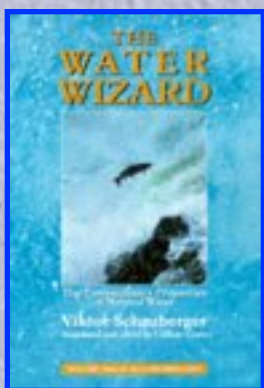

1.) The first book of the "Eco-Technology series" - [The Water Wizard](#) - This book gives a lot of history on Schauberger. The nature of water, May 23, 2001

Reviewer: Frank D Germano, from Tafton, PA United States: This is the first book of the "Eco-Technology" series, and as so, gives you the foundation of the theories presented by Viktor Schauberger, and amplified by Callum Coats. It DOES contain quite allot of previous information written in Living Energies (Coat's first Schauberger book), however, the discussion and the text is much

more thoroughly covered. The substance of water, water supply, deep-sea water, the consequences of drinking purely mechanically treated water, notes on the secrets of water, high-frequency water, the pulsation and healing power of water, river regulation, groundwater tables, temperature and movement of water...notice my use of the word WATER. Yes, this book is about water, but, by reading it, just wait until you discover what you DID NOT know about "water". It is a very good start, and as I said, a foundation for understanding the theories of Viktor Schauberger. FDG.

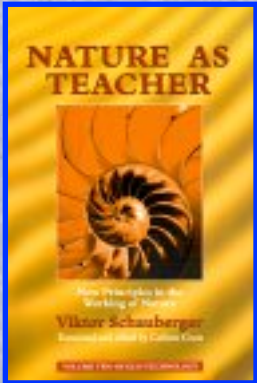

2.) Part two of the "Eco-Technology series" [Nature As Teacher](#). A great book on living with nature. A very nice read.

Our Senseless Toil, May 23, 2001: Reviewer: Frank D Germano, from Tafton, PA United States: I had to use a title from one of the books' opening chapters. This book is going to annoy some people. Callum Coats presents Viktor Schauberger's theories in a modern light. The laws of Nature, Questions for Science, Nature as Teacher, the fish-eagle, the swing, the trout, the ox, dancing logs and stones, the Genesis of water, the coming bio-technical age, the secret of the egg form...these are elucidated...then comes the fun stuff... the age-old secret of the atom, implosive breathing, life-force and animated breathing, is there perpetual motion (?), organic syntheses, the false world view, the mechanical equivalent of heat, plasmolytic motion; this volume gives tremendous insight into what is happening in the world, today, and practical solutions on HOW we may yet save our world. Most telling is Schauberger's inane gut feelings on the powers at work in the environment, and living water. Hey, it's only volume two of the series. Get all four, and see how these books will influence YOU to change the way we look at the earth . FDG

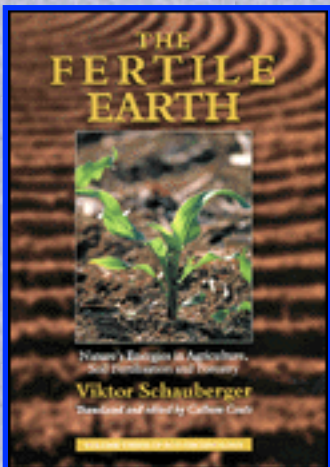

3.) [The Fertile Earth](#) , part three of the "Eco-Technology series. Pure drinking water, how to make it, the benefits produced in the body...the natural flow and paths of rivers, and how man has disturbed nature... organic, natural farming...trees as the life giving force on the earth...it's all hear! Are you trying to save Mother Earth?, May 23, 2001

Reviewer: Frank D Germano, from Tafton, PA United States: If you are in any way interested in the environment, then this book will appeal to you. This is the third book in the highly acclaimed "Eco-Technology" series by Callum Coats. Not only does the book delve into what man is doing to harm the environment, it also offers "fresh" ideas on what we can and should DO about it. I can't believe "Green Peace" or some other pro-environmental group doesn't have this book as part of their by-laws! Fascinating. Of coarse, the entire book is based on the revolutionary work of Viktor Schauberger. This one, if you are into farming, just have a back-yard garden, or are a hard core pro-earth person, will keep you reading till the end...and want to read the entire series. A very well written and inspiring book. A different view of natural

phenomena, the influence of temperature and water movement, forestry, agriculture, the energy industry, the dying forest, timber and water in the building industry, soil fertilization, increased productivity...wow! Again, whether you are just into learning what's happening to the earth, and why, or you are serious about trying to DO something to stop the damage already done, this book will open your eyes. FDG

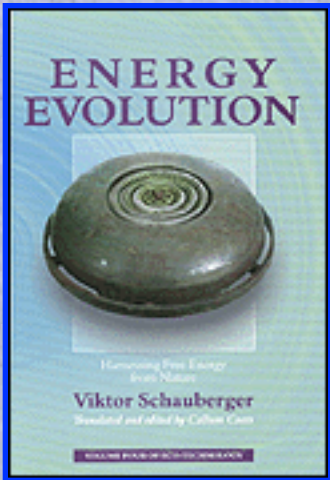

4.) [The Energy Evolution](#) , the final book of the "Eco-Technology series" (If you are interested in the designs and patents on Schauberger's devices, this is the book. Culmination of the Eco-Technology Series, May 23, 2001

Reviewer: Frank D Germano, from Tafton, PA United States: This book, being the fourth and last of the Eco-Technology series, is an incredible finish. Naturally, all of the book deals with Viktor Schauberger, and his theories on living water, and the environment. This book, however, goes deeper into the actual inventions than the previous ones. It contains almost all of Schauberger's patent information, most of which, even

though "lost" originally, is now amplified and explained by Callum Coats. The Trout Motor, the Repulsine, and the rest of Viktor's inventions fall in place like a well stacked deck of cards. You could very easily build these wonderful engines, yourself (with some help from a good machine shop, of coarse!). If you have waited for the conclusion of the series, your wait will be well worth the time. I highly suggest you pick up this copy. FDG

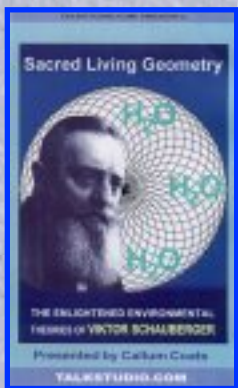

[Sacred Living Geometry:](#)

The Enlightened Environmental Theories of Viktor Schauberger: Our Price: \$39.95

Editorial Reviews: The research of Callum Coats takes us on a journey through the life and inventions of Austrian ecologist Viktor Schauberger (1885-1958). Now, for the first time, you can view the evidence in this detailed, three-hour illustrated lecture presentation on this two video set. Viktor Schauberger was a genius whose ideas were far ahead of his time. He worked as a "forest-master" in the Austrian Alps when they were still a true wilderness. This experience was to influence his entire life's work. Schauberger prophesied the environmental crises we are seeing today, predicting that unless we start to cherish rather than exploit our world, we would surely destroy ourselves. He demonstrated how deforestation would deplete the world of water, causing deserts and climatic chaos. Asked about our technology, "How else

should it be done?" His answer was "exactly in the opposite way that it is done today!" His maxim: "Comprehend and Copy Nature!" From his precise observations of the processes of Nature, Schauberger pioneered a completely new understanding of the nature of water as the most important life-giving and energy-empowered substance on the planet. This led him to develop a radical new science which flew in the face of conventional scientific thinking but which, today, is being increasingly recognized for its highly-relevant implications for civilization. Viktor Schauberger might have made a career as a brilliant inventor. Forced, for a time, to develop radical new forms of propulsion for the Third Reich, he went on to work on devices utilizing the principles of implosion - hundreds of times more powerful than conventional power sources. Even in the weeks just before his death, US government and commercial interests were exerting pressure on him to reveal his secrets. Schauberger's deep insights in the special properties of water and nature hold immense implications for future technology and ecology. On VHS tape, two tapes.



Two Products That I Endorse are the "Electron 3 & 4 Living Water Machine" and the "Wellness Filter Line":



FutureTech Today introduces the [Electron 3 & 4 Living Water Machine](#). This machine is being marketed through Future Tech Today, made by "For Health Reasons" of Chicago Illinois, USA. (makers* of quite probably the best water filtration system, based on victor Schauberger's ideas, of coarse, on the planet! Purer Distilled Drinking Water:

When vapor turns to rain, it passes through temperature gradients where the temperature is continually changing with oxygen. This process stretches and contracts the H bonds that hold the molecules together...this creates ENERGY! Plant diseases are caused by viruses and bacteria, and our method of autoclaving them, using INTENSE HEAT, DESTROYS THEM (NOT just boiling).

The research chemist and others spent thousands of dollars on every product on the market, and ONLY OUR METHOD prevented the diseases in plants and caused incredible growth by just dropping plant buds in the water. Root growth 2 1/2 inches long compared to 1/8 of an inch in any of the others

during the same time frame...even compared to water with nutrients added to the it!! This test was REPEATED over a period of three YEARS ...so there is no mistake!. The BOTTOM LINE is that today's ordinary water is DEAD! Why would ANYBODY want to use DEAD water, and yet most people do! If you can afford the rather steep price of their units, it is well (no pun intended!) worth the price, from personal use, on my end.

*The company that originally produced this unit is listed below - "For Health Reasons" of Chicago, IL. The company SELLING (marketing) the unit is [FutureTech Today](#)... "Future Tech Today was founded in 1998 with ambitions to break the latest energetic healing technologies to the general public while maintaining a research and development program allowing them to bring tomorrow's technology today. The idea was to represent the latest technological research in the fields of energetic medicine, water vitality, and EMF (electro-magnetic field) protection products. They represent products and technologies from all over the world, many of which are in very early stages of production or still in research phases; in this way they give the general public a preview of technologies to come..." (from their website, and used here for endorsement sake) FDG

water-revitalizer.com

ozonedetox.com

rife.biz



[FutureTech Today introduces the Wellness Filter!](#) This is the **Wellness Filter®**, and comes in various sizes to suit individual needs. In my humble opinion - it's the best on the market, today. Pricy, but well worth it. Again, this product is offered through FutureTech, Today. For website info, use either their link - [FutureTech Today](#) - or <http://www.wellness.com.au> (If you go to wellness.com.au directly, you can even become an associate, an affiliate, or a partner-type program with them if you meet their strict company requirements).

"The Wellness Filter® offers you and your family a quality of water that Nature has provided to only a select few. By using natural purification processes in combination with advanced technology, the Wellness Filter® produces what many believe is the best drinking water on Earth. The Wellness Filter® not only removes harmful contaminants but it also enhances the water through a patented process that creates a quality of water beyond the reach of conventional water filters. Clean water plays a vital role in your health, fitness and appearance..." (from the FutureTech Today website).

[\[the Telsa & Schauburger Bookstore\]](#)

VIKTOR SCHAUBERGER:

[\[Water Power - Vortex Theories-\]](#)[\[Water Power II\]](#)

[\[Viktor Schauberger -1-\]](#)[\[Viktor Schauberger -2-\]](#)[\[Viktor Schauberger -3-\]](#)[\[Viktor Schauberger -4-\]](#)

[\[Vortex Science\]](#)

[[Implosion Technology Report](#)]

[\[Christian Links\]](#)



"The Cycloid-Space-Curve-Motion Cycle of Atomic Transitions"

as discovered by the Austrian Physicist,

Viktor Schauburger

[[PAGE ONE](#)] [[PAGE TWO](#)] [[PAGE THREE](#)] [[PAGE FOUR](#)] [Implosion Technology](#)]
 [[HELP FRANK GERMANO!](#)] [[Vortex Science](#)]

The screenshot shows an Amazon.com storefront with a yellow header. On the left, it says "shop now AND SAVE" and "Save big on thousands of products!". On the right, it says "amazon.com and you're done." and "Click Here". Below the header, there are several book listings:

- Living Water** by Olof Alexandersson... New \$18.27!
- Hidden Nature** by Alick Bartholomew. New \$35.00! Used \$23.00!
- Living Water** by Olof Alexandersson... New \$11.95!
- Living Energies** by Callum Coats. New \$17.79!
- Living Energies** by Callum Coats. New \$19.95!
- The Water Wizard** by Viktor Schauburger... New \$12.89!
- Det levande vattnet** by Olof Alexandersson...
- The Fertile Earth** by Viktor Schauburger... New \$13.57!
- Energy Evolution** by Viktor Schauburger... New \$13.57!

At the bottom, it says "(Prices May Change)" and "[Privacy Information](#)".

Very briefly, Schauburger engineered several types of machines that would create an up-current of axially-spinning air so powerful that the up-current's drag force would speed the whole machine higher and higher into the air. Of the many different types of air turbines he made several of them boasted a thrust force of nearly 10,000 bhp - simply by moving air. Some designers have utilized Schauburger's special turbines for flight (see fig. 1) and new research (see below) suggests that there indeed is a strong case for the continuation and re-establishment of Schauburger's research into these hugely beneficial technologies.

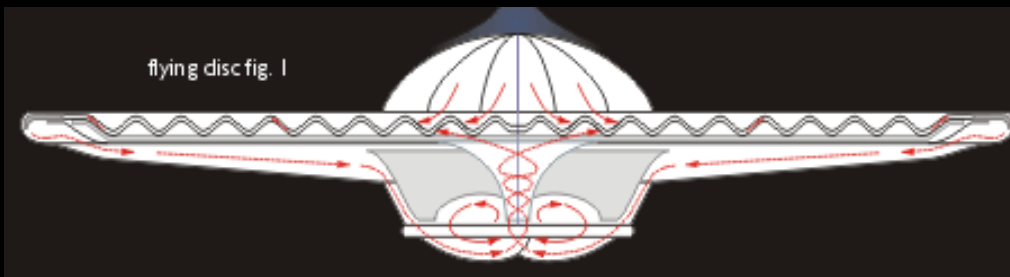

Unfortunately Schauburger was an Austrian caught up in the inhumanities of war-stricken Europe, and at the peak of his creativity was forced to work for the German war effort until the end of WW II. Under orders from Himmler he was to carry out research-and-development for the Germans at Mauthausen

concentration camp where he worked with twenty to thirty prisoner engineers on secret projects centered around 'higher atomic' energies. He received special dispensations from the German SS, for both himself and his prisoner engineers, to carry out this research work. In 1944 he and his engineers were moved, again under the direct orders of the SS, to Leonstein in Austria. At that war's end most of his machines at Leonstein were sequestered by American and Russian 'engineers' and cul-de-sac'd. After the war he moved to Salzburg, but found no-one willing to help him further his researches. Schauburger wanted purely to help humankind make a better world for itself. In return his life's work was taken from him by the arts of businessmen, and he died a broken man in 1958. Perhaps as a gesture of good-will, both the

Russian and American 'engineers' should return these research documents and prototypes to the Schauburger family at PKS Austria, or at least publish the voluminous research works that are, after all, the legacy of one of the greatest engineers of all time.!

But for a collection of notebooks, design-board sketches, and articles published in German periodicals (see [note 1](#)), and a smattering of published patents all of this great man's contribution to New Physics would have been lost to the world.

The subject of Viktor Schauburger's discoveries has no handy starting point, so I'm going to jump straight in where it suits best the overall subject of flying aircraft.

The Pipe - Stage One

Central to any understanding of Schauburger's levitating force is his use of the cycloid-space-curve. This he used to generate a dual flow of fluid through a pipe - of an inner axial flow which moved faster through the pipe than did its peripheral flow which was especially directed into a cycloid path (see fig. 2).

In this flow-separation lay the secret of the inducement of what Schauburger referred to as implosion - a force opposite to but many more times more powerful than ex-plosion. This unique force though was merely one stage in a whole cycle of transitions resulting in a thermo-electric process that transformed ordinary air, water, or sea-water into a super-biomagneto-kinetic force.

The pipe gives one example of how Schauburger brought about what he referred to as a "fermentation" and a "cold-oxidizing" of, as in this case, natural water. The same principle, as will be seen further below, could be applied to atmospheric air. Using Schauburger's terminology, his task was to segregate the *carbone* and the *oxygene* particles of water or fluid, process them, and then reconstitute them with a different energy configuration - with a much higher energy quota than was normal. Then, by using certain characteristics of a vortex, in conjunction with the implosion effect, it would channel the resulting release of repulsion energy and use the energy for kinetic propulsion of the generating device.

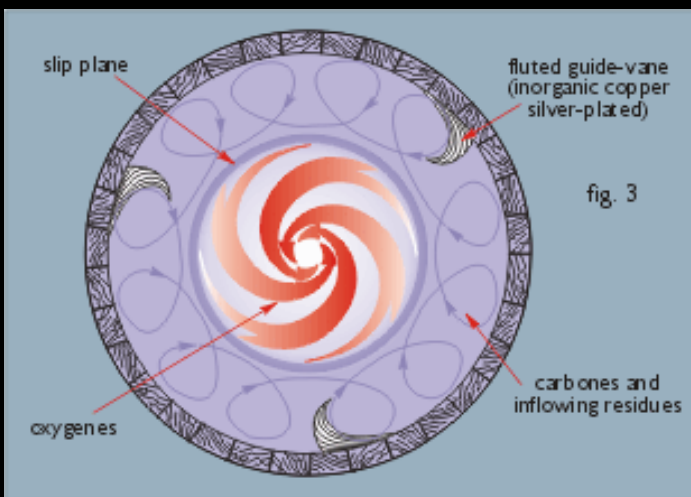
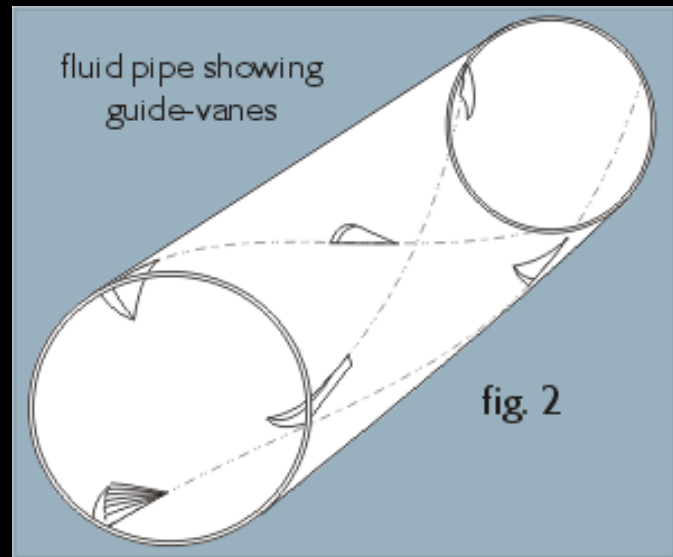

This is how he did it: If you look at the flow patterns drawn into fig. 3, it can be seen that what this pipe created was a peripheral cycloid flow which acted centrifugally, close to the pipe wall. This motion would begin to draw out and harness the organic carbones of the through-flowing water. Correspondingly, tight to the centre of the pipe was drawn the inorganic oxygenes rotating under a centripetal reactive force. His discovery that water's (and air's) carbones react to a centrifugal influence, while oxygenes to a centripetal one having come from many years of previous experimentation and observation (see [note 2](#)).

The special guide vanes secured into the pipe to rotate the peripheral fluid flow were also specifically placed lengthwise at specific intervals, over the whole length of the pipe, to instill an alternating increase and decrease in the flow-pressure along the pipe, which resulted in a general cooling in temperature of the whole water-mass (another one of Schauburger's discoveries - [Viktor Schauburger British Patent: Water conduit, #415280, of 1934](#)).

What occurred under the influence of these opposite motive forces, within the water, was a metabolic process of transformation (see [note 3](#)), or as Schauberger explains, *"It is also known that dissociation and re-combination, therefore the rearrangement of the atoms, can be effected in the substrate with the aid of catalytic processes. In this regard it has been observed that these processes take place in a characteristic cycle or oscillating rhythm until a new state of equilibrium is established"* (see [note 4](#)). The processes that he could generate by using the cycloid-space-curve-motion within an enclosed space would lead to the almost instantaneous production of a lower and a higher product of synthesis (see [note 5](#)), which constituted the *dissociation* part of the process.

Fission and Fusion

Through the cooling of the water the density increases, and as the differentially rotating central core (of oxygenes) and peripheral spiraling carbones rotate about each other their bipolar ingredients constantly abrade at the intervening slip plane and against the outer-wall guide vanes. This breaking down or refining process further induces a dissociation of the micro-particles of the two separated fluid flows, firstly by a process Schauberger named the *oligo-dynamic effect* (see [note 6](#)) of decomposition and hence a liberation of supplementary influences, and secondly, by a shriveling up and densifying of both the oxygene and the carbone elements, thereby creating a reduction in volume. Thirdly the *carbones*, or rather the residues of the carbones, are rendered unipolar (and potentially different from the oxygenes).

As a result, the axial core of the fluid accelerates ahead of the peripheral (spiraling) flow thereby increasing the potential-difference between the two flows. Then, in what can only be described as a highly complicated triggering of bio-electric chain-reactions, there occurs an energetic interchange between the residues of the abraded carbones and the axially-flowing oxygenes. Whereby, as Schauberger stated, "If this state [of interchange] is reached at the anomaly point [of 3.98°C or 39.164°F], then the highly energized organic residues (the former particles of the carbones) bind their fertilizing counterparts (the oxygenes), and the naturalesque product of synthesis is complete" (see [note 7](#)).

One would suppose that this 'charged water' would be likened to a fluid in colloidal form, whereby its molecules would have instilled into them a strong, negative electrical charge, but, according to Schauberger, this was not the case. He proved that the product of this process was a much higher form of energy.

"If on the other hand a tri-polar mass is split up by suction-intensifying and temperature-reducing dynamic influences, then the true creative substance (residues of carbone) will be exposed to revitalizing (cooling) temperatures. In this case the formative pulp-matter becomes free, unipolar and so highly active that it binds, consumes and digests the oxygen, which has become passive under this other dynamic influence. The end product of this magnetolytic dissociation is the predominantly magnetically charged ion, whose original formative and levitative force, which as everything else in Nature is to be understood as an indirect effect, can be intensified by up to 96%. Imbued with levitative force, these ions suck up the inferior matter and the generating device in their wake..." (see [note 8](#)). This was a discovery previously unknown to science at the time.

In conclusion then, from the above delineation of what happens inside this special pipe, at this stage in the transition-process there is a RADIAL-TO-AXIAL (centripetal) force, and chain-reaction, which performs a highly dynamic transformation upon the pipe's through-flowing fluid, whose reaction is to accelerate in a perpendicular motion along the longitudinal axis: By way of an electronic analogy, it is somewhat similar to an outer ring-electrode and a central axial electrode, whereupon a non-uniform electric field exists to create an oscillating combination of *electrophoretic* and *streaming potential* reactions. the reactions of which upon the fluid would be to alternately *generate* electro kinetic energy and be *accelerated* by electro kinetic energy.

One More Step For Mankind - Stage Two

But the Pipe discovery was only the first step toward a Schauberger-type flying aircraft. The next step can be found in Schauberger's centripulser Repulsine machine. When I first saw the drawings of a **Repulsine** prototype made by Schauberger in the 1940's, I thought there *must* be a turbine inside that rotated to create the centrifugal force it required to process it's fluid - but - it seems this prototype didn't work like that. In fact, the whole machine rotated as one unit to create it's centrifugal effect. This rather bulky and cumbersome machine has been

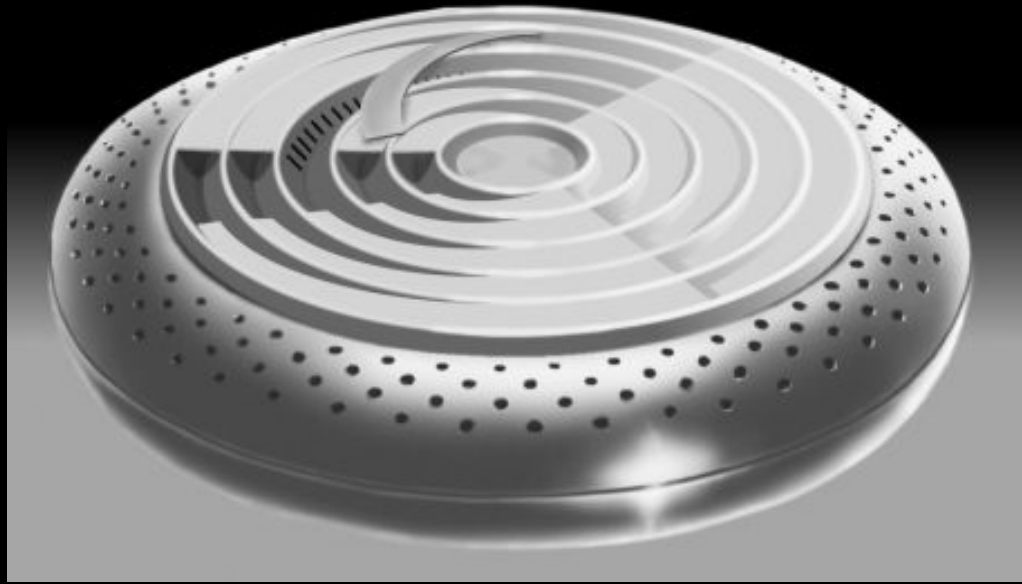

thought, by some researchers, to hold the secrets of gravity-manipulation. This machine was however, more likely to have been built merely as a demonstration model to show others some of the principles of his (Schauberger's) discoveries.

From the sketches for his *other* centripulser turbines such as the *Klimator turbine* and his *Repulsator turbine*, there can be seen the next 'basis', which Schauberger designed into his atom-transforming and levitating machines. For in these machines, the above Pipe processes were transferred to, and configured as, a centrifuging air chamber that alternately braked and pulled upon the air-fluid moving through it.

Inside this Repulsine, the discoveries Schauberger made in the PIPE process, above, were transferred to, and configured as a multi-plated, rotating turbine, with an amazing amount of skill and brilliance. It has to be said, Schauberger and his team of engineers did this task with a creativity and engineering prowess that the old Newtonian physicists of today can only dream of. On close inspection of this machine (in the figures shown here and shown in Schauberger's other patent applications and sketches for his 'centripulser' turbines) can be seen the next 'basis' upon which he designed his atom-transforming and levitating machines.

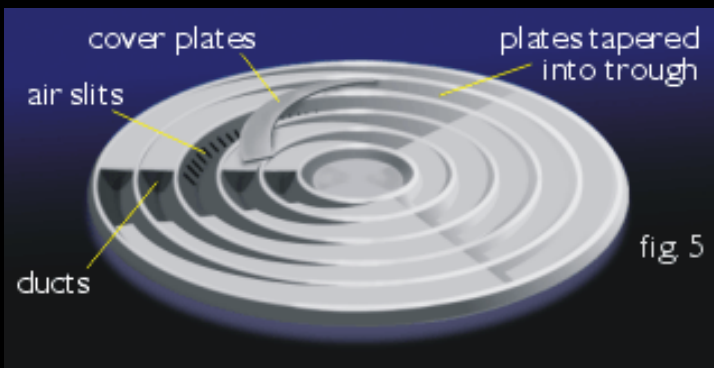

In these centripulser machines, close regard was paid to the principles of the Pipe processes, in that, when the chamber was rotated at above 10,000 rpm a considerable suction was created at the chamber's central inlet ducts as a result of the centrifugal forces dragging the fluid radially outwards (see [note 9](#)). The water, or fluid drawn in, is accordingly, "sucked" through the machine's low-pressure chamber, wherein this flow is 'pummeled' by it's traverse around flow-restrictors (which, for instance, could comprise concentric rings) located inside the chamber in such a way as to shape and to momentarily *exert* pressure on the fluid flow. Additional to these centrifugal (axial

to radial) forces are the *rotational* forces, operating perpendicular to the centrifugal forces, dragging upon the air-fluid inside the low-pressure chamber. Rotating anti-clockwise, the Repulsine's tapering pressure chambers (where the cover plates taper down from the crests into the troughs) acted as a 'multi-stage centrifuge' to create a considerable suction at these 'ducts' (the Repulsine was rotated at around 10,000 rpm) (see [note 9](#) again), the air drawn in was then sucked centrifugally through the two (interconnected) waveform plates, made of inorganic silver-plated copper (see the removed cover plate in fig. 5).

Here then is what Schauburger called the *transition-promoting planetary motion* together with a rhythmical alternation of suction and braking-pressures. This alternating motion causes the dissociation process of the oxygenes and carbones of the through-flowing air into two *separate* components.

For, essentially, there are two forces involved here; the *centrifugal* suction-pressure-suction (which can be made into a rhythmical force), and the rotating *frictional force* of the turbine's low-pressure chamber (spinning at around 10,000 rpm). With these forces, Schauburger used to great advantage the fact that the carbones react more readily to a centrifugal force than do the oxygenes. When the normal (atmospheric) air has entered into the mechanism at the air intakes around the centre and has begun the dissociation process, the oxygenes in the air flowing through will react less to the centrifugal forces than will the carbones (as in the Pipe explanation above) and so the oxygenes will get dragged more by the rotating frictional force inside the low-pressure chamber than will the carbones... meaning that the oxygenes will follow a longer radial curve than will the carbones on their radial flow outwards. There will be a dual flow, just as in the example of the Pipe above, where there will exist an expulsion of a higher and a lower form of this synthesis, which is now ready for the next stage of the process; the process of reconstitution (see [note 10](#)).

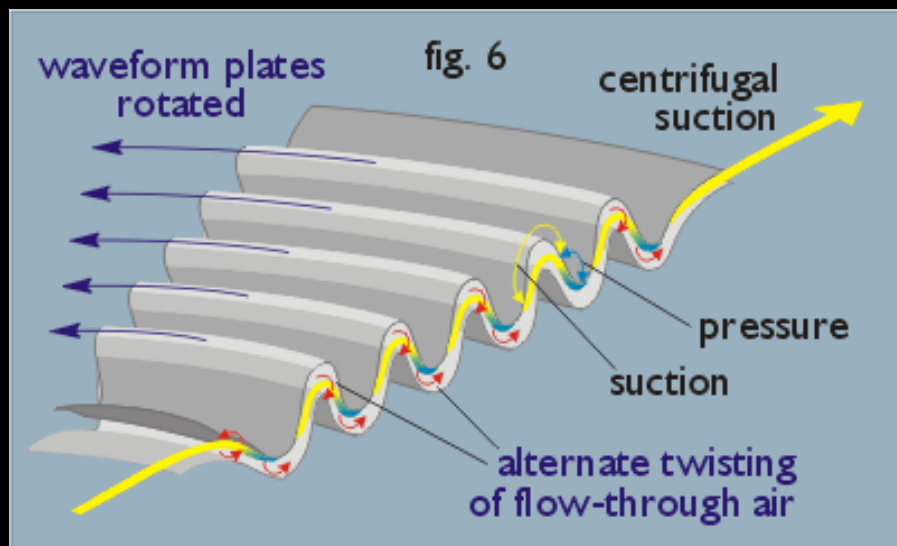

What exits from the turbine at this stage is the 4% carbone + 96% oxygene i.e., the predominantly negatively potentiated energy.

The Work of a True Genius

In order to backtrack a little and show more clearly the process that occurs through the waveform plates, I have drawn in (fig. 7) an exaggeration of the separation effect which takes place (note that on some of Schauburger's prototypes, all five of the concentric waveforms had air intake ducts, while others utilized only two. For the sake of clarity, I have diagrammed here only two such rings of air intakes). Essentially there are two forces involved here; one - the centrifugal suction (which, as we have just seen, is a rhythmical force), and two - the rotating frictional force of the turbine's waveforms (spinning at around 10,000 rpm) in an anti-clockwise direction.

With these forces Schauburger has used to great advantage the fact that the carbones react more readily to a centrifugal force than do the oxygenes.

In (fig. 7) it can be seen that the normal (atmospheric) air enters into the mechanism at the air inlet slits around the center. The oxygens in the air, which react less than the carbones to centrifugal forces (as in the Pipe explanation above) get pulled, or rather dragged, more by the rotating frictional force inside the waveforms, than do the carbones, and so the oxygens follow a longer radial curve than do the carbones on their flow outwards. The carbones (represented in fig. 7 as the wider band on the right) exit through the gaps between the blades on their inside curve, which if you look closely are of a larger radius of curvature than those on the outside, meaning that the air-flow speed will be greater for the oxygens than for the carbones - this provides the slip separation and a slip pressure - just as in the example of the Pipe so as to force the same sort of transformation process... When you then take into consideration what happens at the Repulsine's circumference, where the super-charged air exits, you can see that each pair of higher and lower forms of this synthesis will be squeezed together into a very tightly condensed 'skirt' of energy - ready for the next stage of the process.

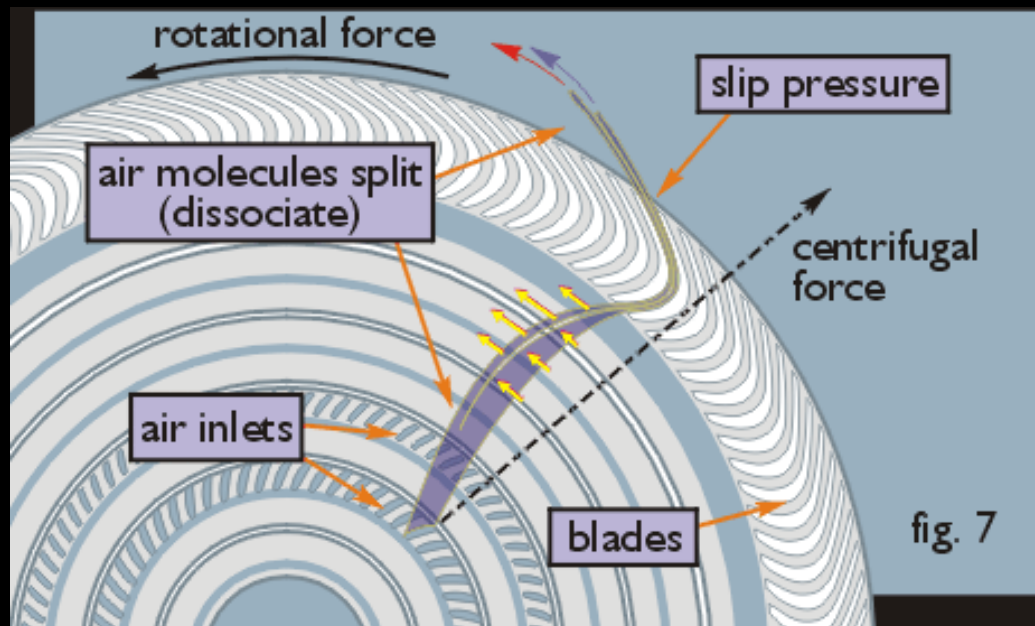

With such ingenuity this man Schauberger should have won the Nobel prize in physics for the Repulsine alone ! But then, seeing as Nobel was the inventor of high explosives, perhaps not...

This is why, when this machine was spun-up a blue-white luminescence could be observed glowing around the outer cowling.

But this stage, as mentioned above, is still only one of potential energy, a potential energy that can be intensified at a ratio of 4 : 96, according to the great man himself.

Stage Three - To Infinity and Beyond...

Now, following on from the above two stages, we have a highly energetic force at the periphery of the machine, which is absolutely crackling with energy. If a suitably curved vessel is located below this rotating peripheral force, and which can turn and guide this force back towards the machine's axis - to transform this energy flow into a centripetal force - then, just as Schauberger describes its effect, it becomes an accelerated radically-to-axially in-winding rotational force.

And we are back at the same situation with what happened inside the Pipe in stage one, where it resulted in the axial fluid being accelerated at great speed through the pipe - well not quite. In this configuration, there is a lot more energy involved, and it has already gone through one stage of synthesis. Now it is being mechanically forced centripetally in towards the centre for its final transformation, the reaction to which is very forceful. This is IMPLOSION.

This is one of Viktor Schauberger's descriptions of what happens next to this energy;

"As the end product of a natural or unnatural sequence of motion, it will be accelerated along either the longitudinal or the transverse axis. In the naturalesque - formative - direction of acceleration, which must take place along the longitudinal axis (centripetally), so-called electricism acts as the absolutely indispensable resistance for all motion. As the formative velocity rises, the resistance increases commensurately in order to provide the additional frictional (resisting) surfaces required by the accelerating matter. The actual loss of formative energy associated with this amounts to about 4%, i.e. in this case

approximately 96% of the formative energy (= magnetism streaming upwards at enormous speed = levitism) is freed, which sucks up its generating device and a portion of its immediate environs in its wake" (see [note 10](#)).

Indeed, in all of Schauberger's descriptions of this levitative force he nowhere describes it as either a propulsive effect i.e. created by a pressure-force, or as an electrical effect i.e. an electrokinetic force.

May the Force be Levitative

This force was one that streamed in spiral fashion upwards above the machine from the machine at high speed, and which drew the generating machine or craft up in its wake - an inverted vortex or black hole if you will. Schauberger variously referred to this projectile of force as a "magnetism", a "biomagnetism", an "organic vacuum", an "all-attracting force" or, as it was most often called, a "diamagnetismus" (see [note 11](#)).

Essentially it seems to have been the second stage of implosion. The first stage of implosion is the densifying effect (where the products implode under the centripetal cycloid motion and are squeezed into an ever-decreasing space where, as he says, they become increasingly densified) but there must follow on from this a repulsion force - as the next natural progression - which, just like in the Pipe process, shoots the product out of this densified core like a bullet high into the air (see [note 12](#)).

Stage Four - Flying Disc:

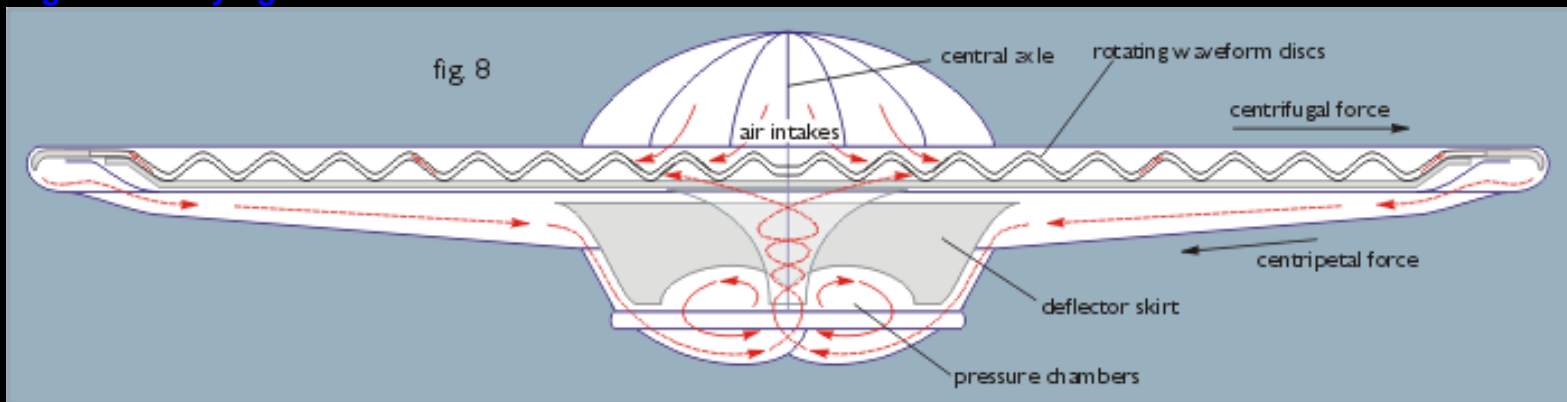

Archimedes displaced...

When Schauberger strove to explain his principles of levitating energy he drew upon the famous observation made by the Greek Archimedes and gave it a new twist, which I will try and duplicate here. Here is what Archimedes would like to have said:

One - Since every body loses weight in proportion to the degree to which it is displaced by a specifically densifying medium (see [note 13](#))... then,

Two - Sit in bath = loose weight (displacement of water).

Three - Sit on floor = loose no weight (no displacement of medium).

Four - If medium surrounding is more dense then it determines motion.

Five - Schauberger's trout (see [note 14](#)) expulses a densified fluid about its rear, as it expands it squeezes the trout forward.

Six - If you create a situation where normal air is more dense than the air directly above or ahead of the craft - the normal air will move the craft !

Seven - There are two sorts of 'levitational motive force' featured in the many machines of Viktor Schaubberger...

Eight - One, a spinning upwards force would provide a NEGATIVE (vacuous) air density above the craft. Two, if the craft utilized only the centrifugal force, as in a Repulsine, it would propel a POSITIVE (increased) air density below the craft. Both these motive forces will send the craft up into the air. May his work continue...

After reading through this webpage, some of you must be wondering - WHY - this amazing technology hasn't seen the light of day, so to speak. Well, the answer is not as easy to explain as one might think. With the help of remnants from my former company, "International Turbine And Power, LLC, we are pioneering the use of the Tesla-type bladeless turbine. We have also begun the design phase for the Schaubberger implosion motors. The turbine, as far as a commercially viable product is one thing. The Schaubberger "free" energy devices are quite another. I invite you to click on this link for a few surprising thoughts and ideas that should startle you. [For the answer: click here](#). After you've had the chance to read this great article, return to this webpage. Further down the page you will find some great books covering all of the information presented on this page. Below that, you will find links to products that utilize the Schaubberger principles. Enjoy. FDG

NOTES:

I must here say a special thanks to Callum Coats for his unstinting dedication toward his goal of getting out into the world an English translation of at least some of the writings of this great man Viktor Schaubberger, certainly without Callum's books I would not have understood Viktor's valuable contribution to the re-alignment of scientific knowledge.

Note 1 - While Viktor was still alive he worked with Aloys Kokaly in Germany to write articles about the many discoveries he had made throughout his life, these were collected and published in German in the "Implosion" magazines, which can now be obtained from Klaus Rauber at: Geroldseckstr. 4, 77736 Zell a.H., Germany
Another source of Viktor's scientific work is the "Mensch und Technik - naturgemäß" German periodical.

Note 2 - See his Fluid Pipe patents Austrian 134543 (1933), 136214 (1934), 138296 (1934). And too the explanation of them in "Living Energies" by Callum Coats p180-2. Also patents Austrian 196680, and French 1057576 (translated in "The Energy Evolution" by Callum Coats p104-114). Note that my fig. 3 is different from that shown in Callum's books because I believe it more accurately portrays Viktor's own explanation. For the difference in reaction between the oxygenes and the carbones to centrifugal forces see Viktor's text translated in "The Energy Evolution" p102 and 57.

Note 3 - Another of Viktor's explanations for this transformation is; *"Like the beads of carbon-dioxide in water that has been warmed, through the strong influence of heat the residual substances shrivel up after the separation and precipitation of the higher quality constituents. Due to the high pressure the outer envelope or the carrier substance will be crushed and in this way the de-energized elements released.*
The opposite primary elements, the varieties of so-called oxygen, will be physically released at higher temperatures, i.e. they attain the so-called charged state that enables them to consume, or as the scientist says, to bind their as it were 'devoted' condensed counterparts" (from Viktor's text translated in "The Energy Evolution" p100).

Note 4 - This is from the patent application Austrian 146141, and from its English translation in "The Energy Evolution" p189.

Note 5 - From Viktor's text translated in "The Energy Evolution" p100.

Note 6 - The oligo-dynamic effect is a necessary stage in the cycle-of-action of a substance's rejuvenation, whereby the

substance is broken down (decomposed) in readiness for its next stage of development. See also Viktor's text translated in "The Energy Evolution" p102/3 and p70-3.

Note 7 - From the English translation in "The Energy Evolution" p103.

Note 8 - From the English translation in "The Energy Evolution" p83.

Note 9 - See the implosion machines featured in "Living Energies" p275-293 where Callum Coats gives the rotational speed as between 10,000 and 20,000 rpm, and an English translation of the Repulsine patent document in "The Energy Evolution" p189-195. The 'basic' concept is to be found in "Mensch und Technik - naturgemäß" Special edition Vol 2, 1993, section 7.5, whereupon the English translation of it can be found in "The Energy Evolution" p165.

Note 10 - From the English translation in "The Energy Evolution" p82.

Note 11 - It was probably a big mistake to call this force "diamagnetismus", which Viktor meant as '*through an attracting force that moved in a magnetic flux-like curve*' to describe an involuting motion, which always converges toward a line, while at the same time curling back in on itself... because it got miss-translated in English (and especially by the American scientists after the war) to represent DIAMAGNETIC as in the Hall effect or the attribute of a bismuth or a copper - which is a miniscule effect detected only in micro-electronic semi-conductors. A lot of people get fooled by that one, I certainly did - a long time ago!

In some cases, more with regard to the implosion of water than of air, Viktor refers to this "*attracting magnet for the surrounding air-masses*" as *dissociated (H)*, where H referred partly to a suctional force, and partly to an atom of the least amount of density, more from the fact that there just wasn't a better way of describing this previously unrecognized force.

Note 12 - This second stage of implosion describes the process of inter-atomic repulsion, where the atomic lattice (and the inter-atomic spacing therein) can collapse only so far, because whoever constructed this universe ensured that when the inter-atomic spacing reaches a certain level of compression the atoms gain a repulsion force - and the greater the compression, or densifying, the greater the magnitude of repulsive forces the atoms gain. Viktor does actually say that at the formative stage (of implosion) the up flowing force does encounter a resistance which increases "commensurably in order to provide the additional frictional surfaces required by the accelerating matter" (from the English translation in "The Energy Evolution" p81/2).

Note 13 - From the English translation in "The Energy Evolution" p214.

Note 14 - Viktor used the example of the trout's swim upstream as the foundation for his research into Implosion - biologists and scientists would do well to learn from it. Also see "Living Energy" p142.

END

Suggested Books: "Energy Evolution", and "Living Energies", below.

Lastly, continue to "[Implosion Technology Report](#)" for my views on how to implement this amazing technology into today's society. Below, you will find books on Viktor Schauburger, from Amazon.com, and five websites that I highly rate for their work with Schauburger type products. These are all listed here as I have tried and thoroughly enjoy all of their products. Yep...THAT is an endorsement ! FDG

[Subscribe to viktorschaubergergroup](#)

Powered by [groups.yahoo.com](#)

[Learn more about Viktor Schauberger...purchase the books below, from Amazon.com](#)

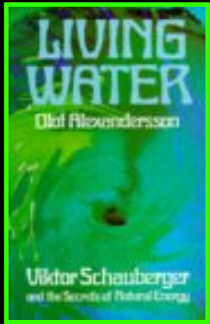

The original translation of Viktor Schauberger's work, "[Living Water](#)", by Olof Alexandersson...start here, and get each one in order. This is an excellent, brief introduction to the thought of Viktor Schauberger, and I hope it inspires works which are more complete. Callum Coates' books reach in this direction, but what is really needed are more people to read these books, synthesize their information, and come up with new and original books which take us further into depth in these areas. This will probably involve synthesizing the work of Schauberger, Grandier, Bienveniste, and others. An understanding of Schauberger is very important for those attempting to reconstruct an Indigenous European Perspective. Schauberger has the elements of a modern water shaman, and his shamanic / intuitive techniques of letting his body float with the water should be closely correlated with what Hans Peter Duerr has to say about "out of body" experience in his tome "Dreamtime". Although Schauberger lived in the 20th Century, his perspective allows us to imagine back what earlier indigenous practitioners may have been like. The Colonial, Imperialist Europe is only one side of the coin of Europe. We must also include the suppressed indigenous, pagan, and green sides. Significantly, the Inquisition represents a watershed in European history where a great deal of the indigenous healers and theorists were wiped out in holocaust proportions. An understanding of Schauberger, coupled with an appreciation of Steiner, Hildegard of Bingen, Hans Peter Duerr, and others, will allow us to reconstruct what a noncolonial, nonimperialist Europe was like. Understanding water's nature is essential in this regard, for water forms the basis of our understandings of flow. Furthermore, understanding water's energetic qualities will help us understand how it interacts with the body. Traditional Chinese Medicine, for example, would benefit from an accurate and holistic understanding of water's qualities. In short, this book is an excellent appetizer.

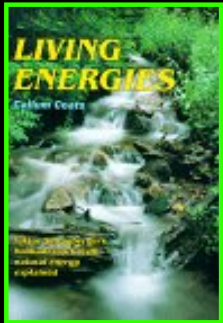

The book that started it all...[Living Energies](#), Callum Coats first Viktor Schauberger book. If you only buy one book, this would be the one to get. Fantastic. Living Energies, May 23, 2001

Reviewer: Frank D Germano, from Tafton, PA United States: This book started it all! Callum Coats basically brought to "light" the resurgence of interest in Viktor Schauberger's theories. This is truly a brilliant work. Water as a carrier of vital energy information, trees as bio-condensers of energy between the deep earth and the sun, how self-cleansing rivers nourish the landscape, how the future of the earth depends on the replanting of natural forests, revolutionary agricultural implements, free energy heater-coolers, jet engines and gravity defying machines invented by Schauberger in the 30's and 40's, home power generators...it's pretty much all here. It was a hard book for me to put down once I started reading, and I go back to it continually for reference. This book pretty much sums up Schauberger's work, which Coats then compartmentalized and expanded in the "Eco-Technology" series with four other books. I would highly advise getting this book, first, and reading it thoroughly, before moving on to the series, as it is a fascinating preface into discovering who Viktor Schauberger WAS, and learning just how far-reaching his theories were, and applicable to us, today. FDG.



1,) The first book of the "Eco-Technology series" - [The Water Wizard](#) - This book gives a lot of history on Schauberger. The nature of water, May 23, 2001

Reviewer: Frank D Germano, from Tafton, PA United States: This is the first book of the "Eco-Technology" series, and as so, gives you the foundation of the theories presented by Viktor Schauberger, and amplified by Callum Coats. It DOES contain quite a lot of previous information written in Living Energies (Coat's first Schauberger book), however, the discussion and the text is much more thoroughly covered. The substance of water, water supply, deep-sea water, the consequences of drinking purely mechanically treated water, notes on the secrets of water, high-frequency water, the pulsation and healing power of water, river regulation, groundwater tables, temperature and movement of water...notice my use of the word WATER. Yes, this book is about water, but, by reading it, just wait until you discover what you DID NOT know about "water". It is a very good start, and as I said, a foundation for understanding the theories of Viktor Schauberger. FDG.

2.) Part two of the "Eco-Technology series" [Nature As Teacher](#). A great book on living with nature. A very nice read.

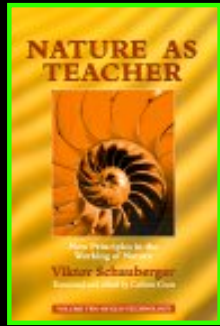

Our Senseless Toil, May 23, 2001: Reviewer: Frank D Germano, from Tafton, PA United States: I had to use a title from one of the books' opening chapters. This book is going to annoy some people. Callum Coats presents Viktor Schauberger's theories in a modern light. The laws of Nature, Questions for Science, Nature as Teacher, the fish-eagle, the swing, the trout, the ox, dancing logs and stones, the Genesis of water, the coming bio-technical age, the secret of the egg form...these are elucidated...then comes the fun stuff... the age-old secret of the atom, implosive breathing, life-force and animated breathing, is there perpetual motion (?), organic syntheses, the false world view, the mechanical equivalent of heat, plasmolytic motion; this volume gives tremendous insight into what is happening in the world, today, and practical solutions on HOW we may yet save our world. Most telling is Schauberger's inane gut feelings on the powers at work in the environment, and living water. Hey, it's only volume two of the series. Get all four, and see how these books will influence YOU to change the way we look at the earth . FDG

3.) [The Fertile Earth](#) , part three of the "Eco-Technology series. Pure drinking water, how to make it, the benefits produced in the body...the natural flow and paths of rivers, and how man has disturbed nature...organic, natural farming...trees as the life giving force on the earth...it's all here! Are you trying to save Mother Earth?, May 23, 2001

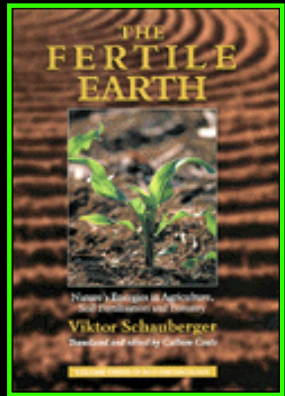

Reviewer: Frank D Germano, from Tafton, PA United States: If you are in any way interested in the environment, then this book will appeal to you. This is the third book in the highly acclaimed "Eco-Technology" series by Callum Coats. Not only does the book delve into what man is doing to harm the environment, it also offers "fresh" ideas on what we can and should DO about it. I can't believe "Green Peace" or some other pro-environmental group doesn't have this book as part of their by-laws! Fascinating. Of coarse, the entire book is based on the revolutionary work of Viktor

Schauberger. This one, if you are into farming, just have a back-yard garden, or are a hard core pro-earth person, will keep you reading till the end...and want to read the entire series. A very well written and inspiring book. A different view of natural phenomena, the influence of temperature and water movement, forestry, agriculture, the energy industry, the dying forest, timber and water in the building industry, soil fertilization, increased productivity...wow! Again, whether you are just into learning what's happening to the earth, and why, or you are serious about trying to DO something to stop the damage already done, this book will open your eyes. FDG

4.) [The Energy Evolution](#) , the final book of the "Eco-Technology series" (If you are interested in the designs and patents on Schauberger's devices, this is the book. Culmination of the Eco-Technology Series, May 23, 2001

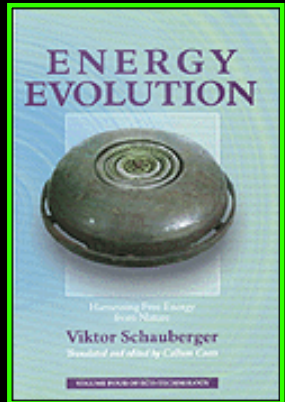

Reviewer: Frank D Germano, from Tafton, PA United States: This book, being the fourth and last of the Eco-Technology series, is an incredible finish. Naturally, all of the book deals with Viktor Schauberger, and his theories on living water, and the environment. This book, however, goes deeper into the actual inventions than the previous ones. It contains almost all of Schauberger's patent information, most of which, even though "lost" originally, is now amplified and explained by Callum Coats. The Trout Motor, the Repulsine, and the rest of Viktor's inventions fall in place like a well stacked deck of cards. You could very easily build these wonderful engines, yourself (with some help from a good machine shop, of coarse!). If you have waited for the conclusion of the series, your wait will be well worth the time. I highly suggest you pick up this copy. FDG

Sacred Living Geometry:

The Enlightened Environmental Theories of Viktor Schauberger: Our Price: \$39.95

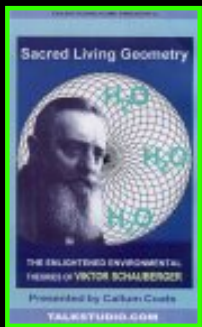

Editorial Reviews: The research of Callum Coats takes us on a journey through the life and inventions of Austrian ecologist Viktor Schauberger (1885-1958). Now, for the first time, you can view the evidence in this detailed, three-hour illustrated lecture presentation on this two video set. Viktor Schauberger was a genius whose ideas were far ahead of his time. He worked as a "forest-master" in the Austrian Alps when they were still a true wilderness. This experience was to influence his entire life's work. Schauberger prophesied the environmental crises we are seeing today, predicting that unless we start to cherish rather than exploit our world, we would surely destroy ourselves. He demonstrated how deforestation would deplete the world of water, causing deserts and climatic chaos. Asked about our technology, "How else should it be done?" His answer was "exactly in the opposite way that it is done today!" His maxim: "Comprehend and Copy Nature!" From his precise observations of the processes of Nature, Schauberger pioneered a completely new understanding of the nature of water as the most important life-giving and energy-empowered substance on the planet. This led him to develop a radical new science which flew in the face of conventional scientific thinking but which, today, is being increasingly recognized for its highly-relevant implications for civilization. Viktor Schauberger might have made a career as a brilliant inventor. Forced, for a time, to develop radical new forms of propulsion for the Third Reich, he went on to work on devices utilizing the principles of implosion - hundreds of times more powerful than conventional power sources. Even in the weeks just before his death, US government and commercial interests were exerting pressure on him to reveal his secrets. Schauberger's deep insights in the special properties of water and nature hold immense implications for future technology and ecology. On VHS tape, two tapes.



[BACK TO INDEX](#)

FIVE websites that I highly rate for their Schauberger based products. I am not associated with them, but simply love their products. Check 'em out for yourself...!

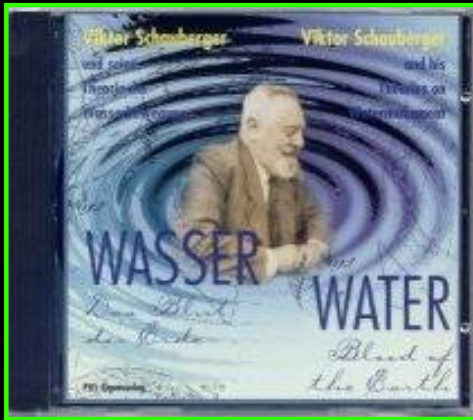

In the 1920s the Austrian forester, hydrologist, hydraulic engineer and inventor Viktor Schaubberger (1885-1958) developed an entirely new view of water as the carrier of life. As an eco-technologist he was able to turn his amazing discoveries into practical applications and enjoyed Europe-wide successes in hydraulic engineering. His inventions for improving water quality caused quite a stir internationally. Today, after decades of obscurity, disregard and suppression, his discoveries are receiving the attention they deserve.

On this CD-Rom, 200 pages of original documents from the Viktor Schaubberger archives at the **PKS** (Pythagoras-Kepler School), Lauffen/Bad Ischl, Austria are published for the first time. The texts, private research findings, patents, as well as 60 graphic images and sketches by Viktor Schaubberger from 1929-1948 exclusively focus on his theories on the movement of water, water quality, the hydrological cycle and naturalesque river engineering. They are cross-referenced in the form of a handbook with hypertext functions. Index and search functions enable easy access.

EARTH TRANSITIONS

Furthermore, the CD contains 8 audio sequences of Viktor Schaubberger's voice (this recording is the only surviving audio document of Viktor Schaubberger), plus 4 video clips with extracts from an historical film about a log-flume erected by Viktor Schaubberger. The CD is in both German and English language. Order through: **Earth Transitions**, or the **Center For Implosion Research**...your choice.

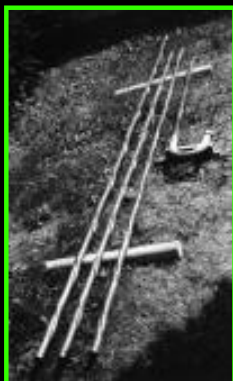

Viktor Schaubberger's "Whorle-pipes"

It's not too often that I will include links to products, other than books on this website. This is one exception. Pictured to the left is a pipe that replicates Viktor Schaubberger's "Whorle pipe" and is of extraordinary construction. I won't waste time, here, with much more of a description. Just click on this (translated by "BableFish") link and go to the website...order one today, and hook it up to your home's water supply: you'll be glad you did. Note: unless you have a translation program on your browser, you'll be stuck in German. Here's the scoop:

Areas of application: The tubes are intended for the energetic revaluation of drinking water. As long as an official examination of the tubes is not present by the TÜV yet, we recommend for the moment only the transfer in accessible areas. For a firm installation under plaster we take over no guarantee. The tubes are checked after distortion random check-well-behaved for 10 cash pressure. The tubes are supplied as bars with different lengths, maximally 2.5 m.

[Association for implosion research and application inc.](#)

This is the link, above, to the Association for Implosion Research website
If you have trouble opening this page, or, if you do not have a German to English Translation program...use this link, below.
Copy/Paste THIS link - (<http://home.t-online.de/home/Klaus.Rauber/verein.htm>) into the "AltaVista - BabelFish" url translation spot...

[BableFish Translation Page](#)

Contact address& email: Klaus Rauber , Geroldseckstr. 4 , 77736 cell a. H. Tel./fax: 07835-5252...email: Klaus Rauber (Klaus.Rauber@t-online.de) use THIS email address to reach Klaus. It is listed incorrectly on the rest of their website.

FDG



ECOWORLD - The Company

ECOWORLD NEW ZEALAND LIMITED, was launched in June 1993 as an environmental marketing company for natural bacterial products. The Grander "Living Water" Systems were soon added to ECOWORLD's list of environmental products once the far-reaching impacts of this technology were known.

Specific treatment protocols for the natural bacterial products have been tested and developed by ECOWORLD to suit various applications, and service persons are trained in the use of the products. The Grander "Living Water" Technology has been trialed in many different countries and industries with satisfactory results, and a set of installation criteria has been developed for New Zealand conditions.

Both technologies of Bio-Remediation and Grander "Living Water" Treatments are environmentally friendly, they are world-renowned, and they compliment and enhance each other. ECOWORLD are proud to bring these technologies to our part of the world. ECOWORLD operates nation-wide, using mail order and telemarketing methods, and has developed a network of personnel working both in marketing and servicing.

All personnel are environmentally conscious and keen to play their part in promoting New Zealand's clean green image. I've ordered quite a lot of their products, and am thoroughly impressed with the quality. I really like the "Pendant" (you wear this little super ionized water encasing pendant...hey, what the heck...it looks nice, and it makes you feel "good"! I even have given serious thought about becoming one of their distributors. FDG



Centre For Implosion Research

The "CIR" was founded in December 1997 by Dolly Knight, MBBS, GCHM and Jonathan Stromberg, BSc, MSc, DIC, FGS. Dolly holds a degree in Medicine and in

Homeopathy and has cared for and healed many people and animals since the age of three. Jonathan holds a Bachelor of Science in Environmental Geology and a Master of Science in Engineering Geology and is a Fellow of the Geological Society. Both are members of the Scientific and Medical Network.

They believe we have a duty to do whatever we can to improve our ailing planet's environmental condition. Their aim is to realize Viktor Schauburger's goals and develop technologies, which are simple, pollution free and work in harmony with Nature. We hope that their work and products will help to reverse some of the damage already done.

Check out their "Vortex Energizer" series products, and the "Water Egg". All of their products are based in some way on Viktor Schauburger's ideas. This link will take you to their home page...from there, click on the "products" link. The Center For Implosion Research, United Kingdom . FDG



FutureTech Today introduces the **Electron 3 & 4 Living Water Machine**. This machine is being marketed through Future Tech Today, made by "For Health Reasons" of Chicago Illinois, USA. (makers* of quite probably the best water filtration system, based on victor Schaubeger's ideas, of course, on the planet!
Purer Distilled Drinking Water:

When vapor turns to rain, it passes through temperature gradients where the temperature is continually changing with oxygen. This process stretches and contracts the H bonds that hold the molecules together...this creates ENERGY! Plant diseases are caused by viruses and bacteria, and our method of autoclaving them, using INTENSE HEAT, DESTROYS THEM (NOT just boiling).

The research chemist and others spent thousands of dollars on every product on the market, and ONLY OUR METHOD prevented the diseases in plants and caused incredible growth by just dropping plant buds in the water. Root growth 2 1/2 inches long compared to 1/8 of an inch in any of the others during the same time frame...even compared to water with nutrients added to the it!! This test was REPEATED over a period of three YEARS ...so there is no mistake!. The BOTTOM LINE is that today's ordinary water is DEAD! Why would ANYBODY want to use DEAD water, and yet most people do! If you can afford the rather steep price of their units, it is well (no pun intended!) worth the price, from personal use, on my end.

*The company that originally produced this unit is listed below - "For Health Reasons" of Chicago, IL. The company SELLING (marketing) the unit is **FutureTech Today**... "Future Tech Today was founded in 1998 with ambitions to break the latest energetic healing technologies to the general public while maintaining a research and development program allowing them to bring tomorrow's technology today. The idea was to represent the latest technological research in the fields of energetic medicine, water vitality, and EMF (electro-magnetic field) protection products. They represent products and technologies from all over the world, many of which are in very early stages of production or still in research phases; in this way they give the general public a preview of technologies to come..." (from their website, and used here for endorsement sake) FDG

water-revitalizer.com ozonedetox.com rife.biz



FutureTech Today introduces the Wellness Filter! This is the **Wellness Filter®**, and comes in various sizes to suit individual needs. In my humble opinion - it's the best on the market, today. Pricy, but well worth it. Again, this product is offered through FutureTech, Today. For website info, use either their link - **FutureTech Today** - or <http://www.wellness.com.au> (If you go to wellness.com.au directly, you can even become an associate, an affiliate, or a partner-type program with them if you meet their strict company requirements).

"The Wellness Filter® offers you and your family a quality of water that Nature has provided to only a select few. By using natural purification processes in combination with advanced technology, the Wellness Filter® produces what many believe is the best drinking water on Earth. The Wellness Filter® not only removes harmful contaminants but it also enhances the water through a patented process that creates a quality of water beyond the reach of conventional water filters. Clean water plays a vital role in your health, fitness and appearance..." (from the FutureTech Today website).

*FOR HEALTH REASONS
P.O. Box 528492, Chicago, IL. 60652
773-434-5020 / Voice , 561-658-6414 / Fax

Never change another water filter again!



Clean Water, of Denmark, with Erik Lavigne: [The Living Water Vortex Jug](#) - Water is the essential component of all life. It comprises 70% of the Earth's surface, 75% of the human body, 90% of blood and sap. 97% of Earth's water is in the oceans, 2% is frozen in icecaps, 1% is fresh, but much of this is inaccessible, deep in the Earth. From what is left, we use 98% for industrial purposes and agriculture, only 2% for the nutrition and health of every living organism.

Water's reputation as a powerful solvent derives from its ability to absorb energy vibrations and its particular electromagnetic and chemical qualities, being able to break down substances into their constituent parts. Naturally flowing water creates complex structures: micro clusters of vibrating energy centres, constantly receiving and transmuted energy from every contact the water body makes; and laminar structures which generate energy from the interaction of the planes against each other.

Healthy water carries nutrients, the building blocks of growth, healing energies, disposes of waste and is constantly cooling, cleansing and purifying itself. We depend on water as a catalyst, a transport system, to maintain our correct body temperature, to supply nutrients and

electrical impulses. Dehydration is a common source of illness - we need to drink 1-2 litres of good water every day, more especially as we grow older. Tea, coffee and alcohol all dehydrate the body, therefore, if we drink them we need to drink more good water to compensate.

We need to protect and care for our water; our survival depends on it. As population increases and industrial growth proliferates, good water is getting perilously scarce. (from Erik Lavigne's site). Pricing is around 60 UK dollars. Ordering info is found on his site.

Books Music	Enter keywords...
	

[HOME](#)

[SITE INDEX](#)

[[the Telsa & Schauburger Bookstore](#)]

VIKTOR SCHAUBERGER:

[\[Water Power - Vortex Theories-\]](#)[\[Water Power II\]](#)[\[Implosion Technology Report \]](#)[\[Vortex Science!\]](#)
[\[Viktor Schauberger -1-\]](#)[\[Viktor Schauberger -2-\]](#)[\[Viktor Schauberger -3-\]](#)[\[Viktor Schauberger -4-\]](#)

[\[Christian Links\]](#)



Christian Bible Study: a starting point for study



This page is laid out in sections.

As you scroll down, you will find study tools, my favorite appendixes of the Companion Bible (E.W. Bullinger's), and a very extensive listing of links to other Christian websites (used by permission from "The Plough"), towards the bottom of the page

May God Bless you in the study of His Word. FDG.

CHRISTIAN BIBLE STUDY TOPICS

(each of these links will take you to a "new" page, from which you can view the topics, below, and return to this section)

[I Garden of Eden | Three World Ages | the Rebellion of Satan | What is the Mark of The Beast ? |](#)

[I Rapture of the Church Bible study | Rapture of the Church: the LIE that leads to the Beast |](#)

[I Christmas | Gentile and the Jew | The Two Figs |](#)

[The Wheat and the Tares](#)

[\[The Cross\] \[The Serpent of Genesis\] \[The Two Great Prophecies of the End Times\]](#)

[[SIGNS! A Witness In The Stars - new -](#)]

[The Shepherd's Chapel, with Pastor Arnold Murray](#)

STUDY TOOLS



The image shows a screenshot of the Amazon.com website. At the top left is the Amazon logo with the tagline "amazon.com and you're done." Below this is a large blue banner with the text "Shop Now & Save" in white. Underneath the banner is a yellow button that says "Click here". To the right of the banner is a list of product categories, each preceded by a blue dot and underlined text. The categories are: Electronics, Books, Music, DVD, Video, Toys & Games, Today's Deals, Kitchen & Housewares, Tools & Hardware, Computer & Video Games, Outdoor Living, Apparel & Accessories, Camera & Photo, and More... At the bottom left of the screenshot, there is a link for "Privacy Information".

- [Online Audio Bible](#): Yes, you can listen to the entire Bible on the Internet! You can also buy Audio Bible as commercial software for your Windows PC.
- [Strong's Concordance](#): use the best available KJV word for word translation and study tool.
- [KJV Online](#): New International Version, New American Standard Bible, New Living Translation, King James Version, New King James Version, Amplified Bible, Revised Standard Version, 21st Century King James Version, NIV (verse by verse), Worldwide English (New Testament), Young's Literal Translation, Darby Translation, American Standard Version, on-line, plus a fantastic verse and word search program - hosted by BibleGateway.com.
- [Interlinear Bible](#) (Greek & Hebrew - a fantastic on-line study aid - Crosswalk.com's Bible Study Tools® are designed to facilitate in-depth study and exploration of God's Word. As the largest resource of its kind on the Internet, this powerful free resource embodies our corporate mission: to equip people to grow in their faith and apply it practically in their lives.)

- [Linked Word King James Bible](#): an entire KJV Bible at your internet fingertips. Simple, direct and straight-forward.
- [Pilgrim's Path](#) (Bible Reference Notes): BIBLE QUICK-REFERENCE - BY TOPIC - an "A" to "Z" listing of most topics with Biblical commentation.
- [Christian Classics Ethereal Library](#): Classic Christian books in electronic format, selected for your edification. There is enough good reading material here to last you a lifetime, if you give each work the time it deserves! All of the books on this server are believed to be in the public domain in the United States unless otherwise specified. Copy them freely for any purpose. Outside of the US, check your local copyright laws.
- [E.W. Bullinger's 198 Appendixes; the Companion Bible](#) ; 198 Appendixes of the Companion Bible: host ; " The Olive Branch ". The Companion Bible with appendixes is quite probably one of the most thorough study tools ever made available in one place. Bullinger takes the reader on a verse-by-verse in depth study of the scriptures, and all without the "classic" bias associated with most study Bibles. Here on line is the complete 198 Appendixes for your convenience and study aid.
- [E.W. Bullinger's 198 Appendixes; the Companion Bible](#) ; this site is hosted by "The Rain" and contains the same 198 appendixes, however, it may be (a bit easier to read) better for some due to the colors of the pages and the size of the print. They have also tried to capture the original "feel" of Bullinger's writing.
- [Passover & the Resurrection of our LORD Jesus Christ](#) - its "miss-translation" into the incorrect word of "Easter"; why our traditional time frame of days just does not add up correctly with God's Word. How many days would Jesus be in the tomb? Scripture tells us three days and nights. See for yourself on a verse-by-verse study. For a quick overview -
 EASTER: from Webster's Dictionary -
 (ê's'ter) n. [[ME ester < OE eastre, pl. eastron, spring,
 Easter; original name of **pagan vernal festival** almost coincident in date with **pashcal** festival of the church < Eastre, dawn goddess. < PGmc *Austro (> Ger Ostern) < IE base *awes-: see EAST]]
 1.) an annual Christian festival celebrating the resurrection of Jesus, held on the first Sunday after the date of the first full moon that occurs on or after March 21st.
 2.) the Sunday of this festival: also
 3.) Easter Sunday
 From the Bible, it appears one time, in **ACTS 12:4** - "intending after *Easter* to bring him..."
 The word in the Strong's Concordance is # 3957 - **pascha**. pas'-khah; of Chaldean or (comp. 6453); **the Passover** (the meal, the day, the festival or the special sacrifices connected with it):
 - Easter, Passover. The King James translators, for who knows what valid reason took the word "pascha" and translated it "easter" and we have been stuck with that name - through the traditions of men - ever since. The highest day of the Christian year, and we call it by a pagan goddess of fertility, taking it even further by allowing our children to roll easter eggs and have cute little bunnies (the signs of the goddess and her fertility rituals!)...do what you like, however,
it is the Passover, and the resurection of our LORD and Saviour, Jesus Christ - not

bunnies and easter eggs...

These three study bibles are, in my opinion, the best available for the study of God's Word.

Available through Amazon.com

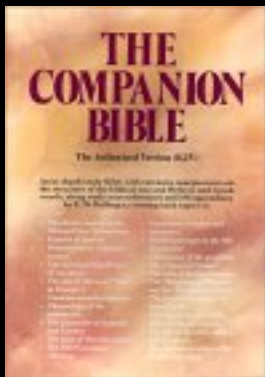

The Companion Bible, by E.W. Bullinger: Thumb indexed, Black Bonded Leather.

List Price: \$88.99 Our Price: **\$62.29**

You Save: **\$26.70 (30%)**

Black Top Grain Leather, Indexed: This beautiful reference work is excellent ., April 10, 1999 Review:

In this generation where technology abounds and biblical works are polluted with man's traditions, I am glad to see that a great work such as the Companion Bible by E.W. Bullinger remains unchanged. Of course, there may be very small flaws in this work but we must remember that the author was not privy to the prophecy that has taken place since its' writing. To the beginning Christian, this work offers a great amount of knowledge in providing you a plan on how to study our Fathers word as well as providing a excellent study on the meaning of Hebrew, Chaldea, and Greek words that have different meanings than what the English rendition would have you to believe. To the in depth student or scholar it provides a excellent source for studying the languages and meanings since it brings in to play text from the MASSORAH and figures of speech that are sometimes misunderstood. It also provides a section of appendixes which are rich in research and information from the only CHRISTIAN SCHOLAR that GINSBERG allowed to proof read the MASSORAH. Take it from a student and a follower of our Fathers word when I tell you that this work along with a good Strong's Exhaustive Concordance of the Bible is invaluable. It is like having a set of the original manuscripts that our Fathers word was translated from. God Bless you all. Now, be a little careful with these links (and prices) from Amazon.com - I will list three links, all to Amazon, but each may have a different price - all are basically the identical Bible - you choose!

[[Companion Bible #1](#)] [[Companion Bible #2](#)] [[Companion Bible #3](#)]

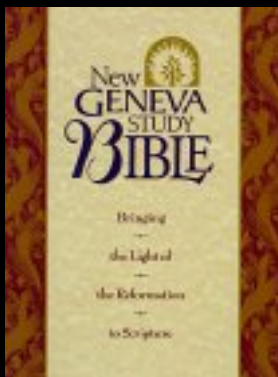

The New Geneva Study BIBLE: Black top-grain leather. Indexed.

Our Price: \$69.95

Book Description

The first Geneva Bible opened the pages of Scripture to readers in the vernacular of the day and provided helpful notes to assist the laity in understanding its message. **The New Geneva Study Bible**, under the editorial leadership of reformed scholars such as R.C. Sproul and J.I. Packer, offers a modern restatement of Reformation truth. The NGSB was a great

addition to my personal library. Not only is the NKJV incredibly easy to read and less watered down than most popular Bibles it is closer to the original than most. I would recommend the NGSB not only for the version it is written in but also because it contains excellent reference notes and scripture explanations. For any reformed Christian who desires to get more in-depth in their personal walk with our Living Savior I would challenge them to view or purchase the NGSB and see for themselves. Taste and see how sweet the Word of God is through this well prayed for text. R.C. Sproul is an incredible teacher of the scripture and it is all laid out for the reader in the NGSB...I've been using study bibles for two decades and I've **never** found a better one. Finally, we have a fully theologically-sound, Grace-centered study bible, with notes and essays from the best scholars (Packer, Sproul, Boice, etc.). Everyone in my church either has one or is getting one.

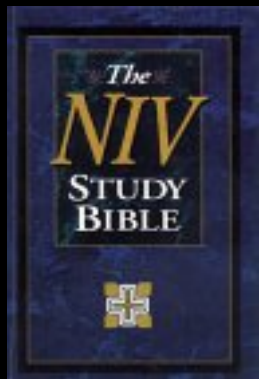

NIV Study Bible, Black Top Grain Leather Indexed

by Kenneth L. Barker, (Editor)

List Price: \$89.99 Our Price: \$62.99

This limited edition is part of the Fall '99 NIV Bible Sale. We are only printing 25,000 units.

Feature for feature, The NIV Study Bible is far and away the finest study Bible available. It is like getting a Bible and a reference library (concordance, atlas, chart book, Bible survey book, topical reference, and a verse-by-verse commentary) in one easy-to-use volume. The NIV Study Bible, which has sold over 4 Million copies, combines the world's best-selling Bible translation--the New International Version--with an astonishing wealth of information. Its 20,000 notes, in-text charts and maps, and comprehensive book introductions have made it a favorite, keeping it on the Bible best-sellers list since its release over 11 years ago. This limited edition will meet the needs of customers who want the full-featured NIV Study Bible in a durable, affordable binding. Since it makes a perfect Christmas gift, it will be a main feature of the NIV Christmas Sale this Fall. This edition is available only as a one-time print run of 25,000 units.

* 20,000 in-text study notes * 100,000 center-column cross references * 80 in-text charts and maps * 62-page subject and note index * 23 pages of full color maps and timelines * A 145-page concordance * Comprehensive book introductions and outlines * Archaeological and historical backgrounds * Study icons * The words of Christ in red * ***The world's best-selling Bible translation: the NIV***

Although this book, below, is not a Bible, it offers more in-depth and truthful commentary than anything I have yet seen. I highly recommend getting a copy and reading it for yourself. I doubt you will be disappointed!

The Bible As It Was

by James L. Kugel

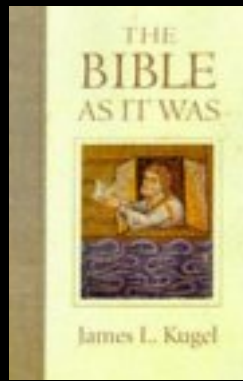

List Price: \$35.00
Our Price: **\$24.50**
You Save: \$10.50 (30%)

The New York Times Book Review, Phyllis Tribble Interpretation is as old as Scripture itself.... Kugel, the Star Professor of Hebrew Literature at Harvard University, shows that what Scripture began, its readers continued. His main purpose is to provide a detailed look at how the Torah, the first five books, was interpreted in antiquity, most particularly from the third century B.C. through the first century A.D.

James Kugel's *The Bible As It Was* is an eye-opening study of early scriptural interpretation. Kugel focuses on readings of the Torah (the first five books of the Hebrew Bible) from 100-300 A.D., particularly the Jewish tradition of midrash--a practice of filling in the narrative gaps where biblical stories are ambiguous or unclear. Kugel's interest in midrash is more than academic, however. He wants readers to consider the ways these early readings of the Bible affect today's popular understandings of scriptural texts (such as the sacrifice of Isaac or the creation in Genesis); and he provides a convincing description of the richness and complexity that informs what seem to many like simple, commonsense readings of scripture. "The Bible as it was" is a wonderful and exhaustive work regarding scriptural interpretation and the first five books of the Bible. Early Jewish tradition was to fill in interpretive information when necessary to resolve items that were ambiguous or unclear. In addition, notes and commentary were often passed along with the texts and over time tended to become a part of the text. As a result, the Bible of today includes a lot of commentary as well as the original texts.

Kugel's purpose is to try to reconstruct the Bible as it was in its original form as closely as possible. While we all know that no copies of the original Bible exist today, the King James version was based on the Textus Receptus which was a Greek translation of the Bible and considered the oldest reliable source at the time. Since then there have been many archaeological finds of manuscripts from earlier points in time and in the original Hebrew language. Many of these passages differ somewhat from current translations. In theory, the older versions should be closer to the original version. Working from the oldest texts he examines some of the differences in the way passages were interpreted and what that could mean. This gets us closer to an original version without all the intervening thoughts and interpretations that earlier writers had added in an attempt to make it more understandable and applicable to the people of their time. Dr. Kugel thoroughly documents his work complete with quotes, sources and annotations as appropriate. A fascinating book that sheds new light onto many passages it should be read by anyone attempting a serious and scholarly study of the Bible



GET THIS BOOK! Here's a review from someone named only as "Bob" and,

I'll tell ya - it's about as accurate as it comes: "I must confess I was a rapture believer prior to absorbing this book, but now I'm free of this deception thanks to Mr. Crux. Not only am I free of the lie, but all those years I was not attending church, I feel I made up for in this one book. From this single book "Beguiled by rapture deception" I have gained more knowledge and understanding of bible than the majority of my friends who have attended churches on a regular basis their entire lives. Few books offer such profound insight as this one. I have been around a long time and know a best seller when I read it, and this has best seller potential written all through it. I know the bias's that exist in the industry between the self and traditional publishing market, and it's to bad because every so often a self published book arises that demands the same recognition and attention of those quality traditional published materials and beguiled by rapture deception certainly is one of them.

I'll put my reputation on the line and say "if you stock this book I guarantee it will sell."

No store wants deadwood sitting on their shelves, space is valuable and something that isn't selling is costing money. This book however I guarantee if presented in view of patrons along with the other new releases will fly off the shelves before many others do. I would also encourage everyone who reads it to support it on the internet thru advertising in homepages, websites, links etc.

The cover carries the title of the Christian theme...as the serpent beguiled eve...the tile reflects the books content as does the picture...the font is elegant being easy to read...containing the crimson word "Rapture" in grabbing attention as a notable sine of warning. The cover while simple does the job in supplying all the necessary elements in proper cover design. While the cover picture could have been more hi-tech and possibly questionable or more subdued as in a Garden of Eden theme, I don't feel it could have been any better in describing the books intent and subject.

I recommend this book to everyone because the value of the content out weighs everything else. I myself plan on giving copies to others as my personal witness, so I too can gain those works Mr. Crux pointed out, that I may be clothed in works not being found naked and ashamed having none when the Lord returns, as everyone one should strive to do the same. Give a copy as your personal witness."

Below are some of my favorites, from Bullinger's Companion Bible ([the appendixes of the Companion Bible](#))

Scroll down the page further, for a very extensive list of more Christian website links.



Why our "traditional" Good Friday through to "Easter" time-frame just doesn't add up in God's Word.

Think about this...how many days are there between "Good Friday" and "Easter" Sunday? I count two. Yet, the Bible specifically states that Christ would be in the tomb for *three* days and nights. Let's see what God's Word - The Bible - has to say:

156. "SIX DAYS BEFORE THE PASSOVER" (John 12:1).

We are furnished by Scripture with certain facts and fixed points which, taken together, enable us (1) to determine the events which filled up the days of "the last week" of our Lord's life on earth; (2) to fix the day of His crucifixion; and (3) to ascertain the duration of the time He remained in the tomb.

The difficulties connected with these three have arisen (1) from not having noted these fixed points; (2) from the fact of Gentiles' not having been conversant with the law concerning the three great feasts of the LORD; and (3) from not having reckoned the days as commencing (some six hours before our own) and running from sunset to sunset, instead of from midnight to midnight.

To remove these difficulties, we must note :--

I. That the first day of each of the three feasts, Passover, Pentecost, and Tabernacles, was "a holy convocation", a "Sabbath" on which no servile work was to be done. See Lev. 23:7, 24, 35. Cp. Ex. 12:16.

"That Sabbath" and the "high day" of John 19:31, was the "holy convocation", the first day of the feast, which quite overshadowed the ordinary weekly Sabbath.

It was called by the Jews *Yom tov* (= Good day), and this is the greeting on that day throughout Jewry down to the present time.

This *great* Sabbath, having been mistaken from the earliest times for the *weekly* Sabbath, has led to all the confusion.

II. This has naturally caused the further difficulty as to the Lord's statement that "even as Jonah was in the belly of the fish three days and three nights, so shall the Son of man be in the heart of the earth three days and three nights" (Matt. 12:40). Now, while it is quite correct to

speaking according to Hebrew idiom of "three days" or "three years", while they are only parts of three days or three years, yet that idiom does not apply in a case like this, where "three nights" are mentioned *in addition* to "three days". It will be noted that the Lord not only definitely states this, but repeats the full phraseology, so that we may not mistake it. See the subject fully discussed in Ap. 144.

III. We have therefore the following facts furnished for our sure guidance :

1. The "high day" of John 19:31 was the first day of the feast.
2. The "first day of the feast" was on the 15th day of Nisan.
3. The 15th day of Nisan, commenced at sunset on what we should call the 14th.
4. "Six days before the Passover" (John 12:1) takes us back to the 9th day of Nisan.
5. "After two days is the Passover" (Matt. 26:2. Mark 14:1) takes us to the 13th day of Nisan.
6. "The first day of the week", the day of the resurrection (Matt. 28:1, &c.), was from our Saturday sunset to our Sunday sunset. This fixes the days of *the week*, just as the above fix the days of *the month*, for:
7. Reckoning back from this, "three days and three nights" (Matt. 12:40), we arrive at the day of the burial, which must have been before sunset, on the 14th of Nisan; i.e. before our Wednesday sunset.
8. This makes the sixth day before the Passover (the 9th day of Nisan) to be our Thursday sunset to Friday sunset.

Therefore Wednesday, Nisan 14th (commencing on the Tuesday at sunset), was "the preparation day", on which the crucifixion took place : for all four Gospels definitely say that this was the day on which the Lord was buried (before our Wednesday sunset), "because it was the preparation [day]" the bodies should not remain upon the cross on the Sabbath day, "for that Sabbath day was a high day", and, therefore, not the ordinary seventh day, or weekly Sabbath. See John 19:31

IV. It follows, therefore, that the Lord being crucified on "the preparation day" could not have eaten of the Passover lamb, which was not slain until the evening of the 14th of Nisan (i.e. afternoon). On that day the daily sacrifice was killed at the 6th hour (noon) and offered about the 7th hour (1 p.m.). The killing of the Passover lambs began directly afterwards. Thus it is clear, that if the killing of the Passover lambs did not *commence* until about four hours after our Lord had been hanging upon the Cross, and would not have been concluded at the *ninth* hour (3 p.m.) when "He gave up the ghost;" -- no "Passover lamb" could have been eaten at the "last supper" on the previous evening.

V. With these facts before us, we are now in a position to fill in the several days of the Lord's last week with the events recorded in the Gospels. By noting that the Lord returned to Bethany (or to the Mount of Olives) each night of that week, we are able to determine both the several days and the events that took place in them.

**THE SIXTH DAY BEFORE THE PASSOVER, THE 9TH DAY OF NISAN.
(Our Thursday sunset to Friday sunset)**

	MATTHEW.	MARK.	LUKE.	JOHN.
The Lord approaches Jerusalem from Jericho		19:1-10	
He passes our Thursday night at the house of Zacchaeus			19:5	
And delivers the Parable of the Pounds			19:11-27	
He proceeds toward Jerusalem			19:28	
He sends two disciples (<i>apenanti</i>) for an "ass" and a "colt" (two animals)	21:1-7			
And makes His first entry from Bethphage (not Bethany) (Ap. 153)	21:8, 9			
He is unexpected, and they ask "Who is this?"	21:10, 11			
He cleanses the Temple	21:12-16			
He returns to Bethany	21:17			12:1

**THE FIFTH DAY BEFORE THE PASSOVER, THE 10TH DAY OF NISAN.
(Our Friday sunset to Saturday sunset.)**

The Lord passes the Sabbath at Bethany; and after sunset (on our Saturday), the first of three suppers was made, probably at the house of Lazarus, in Bethany (Ap. 157)	12:2
--	-------	-------	-------	-------------

At this supper the first of two anointings took place (Ap. 158)				12:3-11
---	--	--	--	---------

THE FOURTH DAY BEFORE THE PASSOVER, THE 11TH DAY OF NISAN.
 (Our Saturday sunset to Sunday sunset), the Gentile "Palm Sunday".

The second, or triumphal entry into Jerusalem. He sends two disciples (<i>katenanti</i>) for a colt (one animal). See Ap. 153	11:1-7	19:29-35	12:12-
The Lord starts from Bethany (not Bethphage) and is met by multitudes from Jerusalem (Ap. 153).		1:8-10	19:36-40	12:12-19
He weeps over the city.			19:41-44	
He enters the Temple, looks around.		11:11-		
And Returns to Bethany.		11:11		

THE THIRD DAY BEFORE THE PASSOVER, THE 12TH DAY OF NISAN
 (Our Sunday sunset to Monday sunset).

In the morning (our Monday a.m.) the Lord returns to Jerusalem.	21:18	11:12		
The Fig-tree cursed.	21:19-22	11:13, 14		
The Temple. Further cleansing.		11:15-17	19:45, 46	
In the Temple. Further teaching. "Certain Greeks".			19:47-	12:20-50
Opposition of Rulers.		11:18	19:-47, 48	
He goes out of the city (probably to Bethany; see Luke 21:37, 38, below).		11:19		

**THE SECOND DAY BEFORE THE PASSOVER, THE 13TH DAY OF NISAN.
(Our Monday sunset to Tuesday sunset).**

In the morning (our Tuesday a.m.) on the way to Jerusalem, the question of the disciples about the Fig Tree.		11:20-26	
In Jerusalem again; and in the Temple.	21:23-27	11:27-33	20:1-8	
In Jerusalem teaching in Parables; and questions.	21:28-23:39	12:1-44	20:9-21:4	
The first great prophecy, in the Temple (Ap. 155).			21:5-36	
(Parenthetical statement as to the Lord's custom during this week).			21:37, 38	
The second great prophecy, on the Mount of Olives.	24:1-51	13:1-37		
The second great prophecy, continued (Ap. 155).	25:1-46			
"After two days is the Passover".	26:1-5	14:1, 2		
He returns to Bethany, and is present at the second supper in the house of Simon the leper. The second Anointing. See Ap. 157 and 158.	26:6-13	14:3-9		

**THE DAY BEFORE THE PASSOVER -- THE 14TH DAY OF NISAN --
"THE PREPARATION DAY" -- THE DAY OF THE CRUCIFIXION.
(Our Tuesday sunset to Wednesday sunset).**

The plot of Judas Iscariot to betray the Lord.	26:14-16	14:10, 11	22:1-6	
---	-----------------	------------------	---------------	--

The "preparation" for the last supper (*1).	26:17-19	14:12-16	22:7-13	
"The even was come" (our Tuesday after sunset) when the plot for the betrayal was ripe for execution.	26:20	14:17		
The last supper, commencing with the washing of the feet.				13:1-20
The announcement of the betrayal, &c.	26:21-25	14:18-21		13:21-30
The supper eaten, the "New Covenant" made (Jer. 31:31). The lamb abolished, bread and wine substituted.	26:26-29	14:22-25	22:14-23	
The first prophecy of Peter's denials (Ap. 160).				13:31-38
The strife; who should be the greatest, &c.			22:24-30	
The second prophecy of Peter's denials (Ap. 160).			22:31-34	
The final appeal to His first commission (Luke 9:3).			22:35-38	
The last discourse to the eleven, followed by His prayer.				14:1-17:26
They go to Gethsemane.	26:30-35	14:26-29	22:39	18:1
The third prophecy of Peter's denials (Ap. 160).		14:30, 31		
The agony in the garden.	26:36-46	14:32-42	22:40-46	
The apprehension of the Lord (Ap. 165).	26:47-56	14:43-50	22:47-54	18:2-11

The escape of Lazarus (see notes on Mark 14:51, 52).		14:51, 52		
The trials: continued throughout our Tuesday night.	26:57-27:31	14:53-15:19	22:54-23:25	18:12-19:13
About the sixth hour (our Tuesday midnight) Pilate said "Behold your King".				19:14, 15
Led away to be crucified.	27:31-34	15:20-23	23:26-31	19:16, 17
And "led with Him" two "malefactors" (<i>kakourgoi</i>) (Ap. 164).			23:32, 33	19:18
Discussion with Pilate about the Inscriptions (Ap. 168).				19:19-22
The dividing of the garments.	27:35-37	15:24	23:34	19:23, 24
"It was the third hour, and they crucified Him" (our 9 a. m. Wednesday).		15:25, 26		
"Then were there two robbers" (<i>Iesta</i>) crucified with Him" (Ap. 164).	27:38	15:27, 28		
The revilings of the rulers, both "robbers", and one "malefactor".	27:39-44	15:29-32	23:35-43	
The Lord's mother and John.				19:25, 27
"The sixth hour" (our Wednesday noon) and the darkness (Ap. 165).	27:45-49	15:33	23:44, 45	
"The ninth hour" (our Wednesday 3 p.m.) and the expiring cry (Ap. 165).	27:50	15:34-37	23:46	19:28-30

Subsequent events	27:51-56	15:38-41	23:47-49	19:31-37
Buried in haste before sunset (our Wednesday about 6 p.m.), before the "high day" (the first day of the Feast began), our Wednesday sunset.	27:57-66	15:42-47	23:50-56	19:38-42

**"THE FIRST DAY OF THE FEAST" - "THE HIGH DAY" (Yom tov) - THE 15TH DAY OF NISAN.
(Our Wednesday sunset to Thursday sunset.)
THE FIRST NIGHT AND FIRST DAY IN THE TOMB.**

**THE SECOND DAY OF THE FEAST - THE 16TH DAY OF NISAN.
(Our Thursday sunset to Friday sunset.)
THE SECOND NIGHT AND SECOND DAY IN THE TOMB.**

**THE THIRD DAY OF THE FEAST - "THE (WEEKLY) SABBATH" - THE 17TH DAY OF NISAN
(Our Friday sunset to Saturday sunset.)
THE THIRD NIGHT AND THIRD DAY IN THE TOMB.**

**"THE FIRST DAY OF THE WEEK" - THE 18TH DAY OF NISAN
(Our Saturday sunset : "the third day" of Matt. 16:21, &c.; not the third day of the Feast.)**

Thus the Resurrection of the Lord took place at our Saturday sunset or thereabouts on "the third day"; cp. "after three days" (Matt. 27:63. Mark 8:31.).	28:1-10	16:1-18	24:1-49	20:1-23
---	----------------	----------------	----------------	----------------

[For the sequence of events connected with and following the Resurrection, see Ap. 166.]

It will be seen from the above that we have neither power nor authority to alter or shift any day or date; or to change the order or position of any of the events recorded in the Holy Writ.

Each day is marked by a return to Bethany during the last week (up to the Preparation Day); and each day is filled with the recorded events.

It follows, therefore, that the Lord was crucified on our Wednesday; was buried on that day before sunset; and remained "three days and three nights" in the tomb, as foretold by Him in Matt. 12:40; rising from the dead on "the third day", "the first day of the week".

The fixed days and dates, at either end, hold the whole period as in a vice, and place the whole subject on a sure foundation.

(*1) The words in Mark 14:12 and Luke 22:7 refer to "the first day of unleavened bread", which was the 14th day of Nisan, and therefore "the preparation day". That is why the Lord goes on to tell the two disciples to go and *make preparation for the Passover*.

148. "THE THIRD DAY."

In the first mention of His sufferings (Matt. 16:21) the Lord mentions the fact that He would be "raised again the third day". In John 2:19 He had already mentioned "three days" as the time after which He would raise up "the Temple of His body".

The expression occurs eleven times with reference to His resurrection (Matt. 16:21; 17:23; 20:19. Mark 9:31; 10:34. Luke 9:22; 18:33; 24:7, 46. Acts 10:40. 1Cor. 15:4.).

We have the expression "after three days" in Mark 8:31, used of the same event. This shows that the expression "three days and three nights" of Matt. 12:40 must include "three days" and the three preceding "nights". While it is true that a "third day" may be a part of three days, including two nights; yet "after three days", and "three nights and three days" cannot possibly be so reckoned.

This full period admits of the Lord's resurrection on the third of the three days, each being preceded by a night, as shown in Ap. 144 and 156. But, why this particular period? Why not two, or four, or any other number of days? Why "three" and no more nor less?

1. We notice that the man who contracted defilement through contact with a dead body was to purify himself on the third day (Num. 19:11, 12).
2. The flesh of the peace offering was not to be kept beyond the third day, but was then to be burnt (Lev. 7:17, 18) as unfit for food.
3. John Lightfoot (1602-75) quotes a Talmudic tradition that the mourning for the dead culminated on "the third day", because the spirit was not supposed to have finally departed till then (Works, Pitman's ed., vol. xii. pp. 351-353).
4. Herodotus testifies that embalmment did not take place until after three days (Herod. ii. 86-89).
5. The Jews did not accept evidence as to the identification of a dead body after three days.

This period seems, therefore, to have been chosen by the Lord (i.e. Jehovah, in the type of Jonah) to associate the fact of resurrection with the certainty of death, so as to preclude all doubt that death had actually taken place, and shut out all suggestion that it might have been a trance, or a mere case of resuscitation. The fact that Lazarus had been dead "four days already" was urged by Martha as a proof that Lazarus was dead, for "by this time he stinketh" (John 11:17, 39). We have to remember that corruption takes place very quickly in the East, so that "the third day" was the proverbial evidence as to the certainty that death had taken place, leaving no hope.

164. THE "OTHERS" CRUCIFIED WITH THE LORD (Matt. 27:38 and Luke 23:32).

Mislead by tradition and the ignorance of Scripture on the part of medieval painters, it is the general belief that only two were crucified with the Lord. But Scripture does not say so. It states that there were two "thieves" (Gr. *lestai* = robbers, Matt. 27:38. Mark 15:27); and that there were two "malefactors" (Gr. *kakouryoi*, Luke 23:32).

It is also recorded that *both* the robbers reviled Him (Matt. 27:44. Mark 15:32); while in Luke 23:39 only *one* of the malefactors "railed on Him", and "the other rebuked him" for so doing (v. 40). If there were only *two*, this is a *real* discrepancy; and there is another, for the two malefactors were "led with Him to be put to death" (Luke 23:32), and when they were come to Calvary, "they" then and there "crucified Him and the malefactors, one on the right hand and the other on the left" (v. 33).

But the other discrepancy is according to Matthew, that *after* the parting of the garments, and *after* "sitting down they watched Him there", that "THEN" were there two *robbers* crucified with Him, one on the right hand and the other on the left" (Matt. 27:38. Mark 15:27). The two malefactors had already been "led with Him" and were therefore crucified "with Him", and *before* the two robbers were brought.

The first two (malefactors) who were "led with Him" were placed one on either side. When the other two (robbers) were brought, much later, they were also similarly placed; so that there were two (one of each) on either side, and the Lord in the midst. The malefactors were therefore the nearer, and being on the inside they could speak to each other better, and the one with the Lord, as recorded (Luke 23:39-43).

John's record confirms this, for he speaks only of *place*, and *not of time*. He speaks, generally of the *fact*: "where they crucified Him, and with Him others, two on this side, and that side, and Jesus in the midst" (John 19:8). In Rev. 22:2 we have the same expression in the Greek (*enteuthen kai enteuthen*), which is accurately rendered "on either side". So it should be

rendered here: "and with Him others, on either side".

But John further states (19:32, 33) : "then came the soldiers and brake the legs of the first, and of the other which was crucified with Him. But when they came (Gr. = having come) to Jesus, and saw that He was dead already, they brake not His legs." Had there been only two (one on either side) the soldiers would not have *come* to the Lord, but would have passed Him, and then turned back again. But they came to Him after they had broken the legs of the first two.

There are two words used of the "other" and "others" in John 19:32 and Luke 23:32 (See Ap. 124. 1). In the former passage we read, "they brake the legs of the first and of *the other*." Here the Greek is *allos* which is the other (the second) of the two *when there are more* (see Matt. 10:23; 25:16, 17, 20; 27:61; 28:1. John 18:15, 16; 20:2, 4, 8. and Rev. 17:10).

In the latter passage (Luke 23:32) the word is *heteros* = different (See Ap. 124. 2) : "and others also, two were being led with Him." These were different (*1) from Him with Whom they were led, not different from one another; for they were "in the same condemnation", and "justly", while He had "done nothing amiss" (vv. 40, 41).

From this evidence, therefore, it is clear that there were four "others" crucified with the Lord; and thus, on the one hand, there are no "discrepancies", as alleged; while, on the other hand, every word and every expression, in the Greek, gets (and gives) its own exact value, and its full significance.

To show that we are not without evidence, even from tradition, we may state that there is a "Calvary" to be seen at Ploubezere near Lannion, in the Cotes-du-Nord, Brittany, known as *Les Cinq Croix* ("The Five Crosses"). There is a high cross in the center, with four lower ones, two on either side. There may be other instances of which we have not heard.

"In the Roman Catholic church ... the altar slab or "table" alone is consecrated, and in sign of this are cut in its upper surface five Greek crosses, one in the center and one in each corner ... but the history of the origin and development of this practice is not fully worked out" (*Encycl. Brit.*, 11th (Cambridge) ed., vol. i, pp. 762, 763). This practice may possibly be explained by the subject of this Appendix.

(*1) Cp. Matt. 6:21, 24; 8:21; 11:3. Luke 5:7; 6:6; 7:41; 9:56; 14:31; 16:13, 18; 17:34, 35; 18:10; 28:40.

What are true dates of our LORD Jesus Christ's birth and conception ?
Click on each link, below.

1.) [The conception: December 25th](#)

2.) [His birth: September 29th](#)

This is a fantastic message for believers at "Christmas" time.

For further study:

1. [\[The Cross\]](#)
 2. [\[The Serpent of Genesis\]](#)
 3. [\[The Two Great Prophecies of the End Times\]](#)
-

Christian Links

These links, and comments, are used by permission from

"The Plough" ...please take the time to visit this wonderful site.

[The Shepherd's Chapel](#), with Pastor Arnold Murray - my teacher...one of the most informative learning experiences concerning the truth of God's Word that I could ever recommend.

[Bible Prophecies for the World Today](#) , This index leads to more than 60 articles, on the Bible, our past, our present and our future. All our information is free, I believe the Lords words should always be free. There are hundreds of Bible quotes explained. There are no fancy graphics or pictures. Read your Bible, check up on me, time is growing very short, wipe the dust from your Bible, it contains a wealth of information. I sincerely hope that the material contained on these pages will help you to understand the Bible better, and that you will make every effort to do so. It will require much reading of the Bible, many times over, before you will understand it. Many people believe that a last minute effort is enough to protect them,.....it isn't. All material may be used for personal use only, and may be printed out for your use without written permission. All pages are printable. May God bless you and yours, and drop in often. The world will never end, but what you see today, when you look out your window, will, and very soon. North America will soon come under attack from an unexpected country,...and we will loose. Australia and the Pacific will come under the control of China. Russia, the Asian countries and the Arab countries will unite as a single fighting unit. These articles contain thousands of reference's so that you may read it in your own Bible, at you own pace. Check it out for yourself. I do not expect you to believe me, but with the many references that are supplied to you, you can see it for yourself, and read it for yourself, in your Bible. Are you open-minded enough to set aside your beliefs? to accept what the Bible actually says?. Can you

choose between what you have been taught to believe and what the Bible says. Religion and the Bible do not in many cases say the same thing. Religion has turned to telling you what you want to hear, if they told you the truth you would leave. Perhaps you can.... but it will not be easy for you. The King James Bible is used in all cases.

[The Plough](#) - This site is an excellent Christian website. On-line Bible study, and wonderful insight on God's view.

[The Org for Biblical Studies](#) - A very well organized site of Biblical references and studies. This site keeps getting better and better! The studies take into account the manuscripts as well as Hebrew, Greek, and Aramaic idioms, symbols, and figures of speech which are too often lost in translations. This site does not disappoint! If you are searching for truth, you will find yourself spending much time at "the Organization for Biblical Studies".

[Bible.net](#) - This is my personal favorite. Complete with on-line study tools, on-line bibles, thesaurus...just about everything you could want in a truly Christian based web page. Definitely worth a visit.

[ShepChap Home Page](#) - A very special ministry and dear to my heart is the Email List and fellowship of Gil and Sher's "SHEPCHAP Group". Working in His field is a blessing when you have company like this! What am I speaking of? You will have to click on the link to find out!

[Israelsregathering.com](#) - Solve the mystery on the TRUE House of Israel. This site features excellent study tools and maps which help trace the migrations of the lost sheep of the house of Israel ([sitemap](#)). Do not miss this truly artistic treasure-trove of Israel's heritage! Beautifully done!

[Battle Hymns](#) - Battle Hymn Ministries is a web site called to teach The Truth as it is revealed through the Holy Spirit. Learn the truth about the twins of Genesis, and the two fig trees! Meditate upon their excellent study entitled "Dispelling the Myths" which unravels things taught contrary to truth. The battle is on!

[Shepherd's Corner](#) - Are you interesting in reading a study with extensive translations to the original languages? This Webmasters simple and accurate style brings forth the Word rightly divided.

[TheRain.Org](#) -This site is designed for the young In Christianity, to help the beginner find a place to start plowing. A growing section at this site not to be missed is that of the Companion Bible Indexes, by E.W. Bullinger. There is also a section of suggested reading for the beginner, and for children. If you need a clear path to truth this site will help keep your footing sure.

[The Olive Branch](#) - The Rainbow's end! Enter this colorful site which contains a vault of truth surely equal to a pot o' gold! Learn the parable of the fig tree - what does it mean to you living

in this generation? Examine a reprint of the letter from Pontius Pilate to Tiberius Caesar describing the Physical appearance of Jesus - take a moment to spend some time at this glowing site, you will be glad you did! Includes Bullinger's appendixes to the Companion Bible, also.

[Study God's Word](#) - Interested in downloading Bible Software? Or a Biblical trivial pursuit? This growing site offers both!

[Kings Chapel](#) - Whether you are a new student of the Bible or a well educated scholar you will find some of Lance's unique style of teaching to be educational, inspiring, relevant to the times we live in, and sometimes humorously uplifting. If you would like to receive a lesson by e-mail, each Monday through Friday, simply send King's Chapel an e-mail request to subscribe. Back issues are available online or in booklet form. This online Chapel is a "chip off the 'ol block" (SC)!

[Across the Rainbow Bridge](#) - This Webmaster answers some deep questions. Studies include; "The Seven Thunders of Revelations", "The Nephilim", "Figures of Speech in the Bible". These are not to be missed! When you are not in study at this site you may send an electronic Christian Greeting, or check out the Midi files, Bible Resources and graphics. A truly wonderful web destination!

[Bible Student Resources](#) - Have you wanted to view the ancient solar calendar? This site offers an explanation and look at this unique yet rare accurate clock. Interested in Studies about the symbolism of God's creatures? Read their Biology section about insects, reptiles and amphibians. Other highlights of this site are the lists of astronomical events along with some Scriptural clues, and a study on the medical terms used in the book of Luke. This site truly lives up to it's name of Student Resources!

[GOD's Hidden Mysteries](#) - Are you one of the more curious people when it comes to unsolved mysteries? You will want to pause at this cyber tour of pyramids, star alignments, visions in smoke, and yes, even crop circles! This site attempts to answer some puzzling questions of this place we call earth with God's Word as the perfect compass.

[Three World Ages](#) - This site lays excellent groundwork in God's Word on the three earth ages. Open God's truth to you by understanding the overthrow of Satan in the first earth age, the plan of the current earth age and what lies ahead because of your own understanding in the third earth age. To further your studies, you may also enjoy the depth of **[a study on the number 666](#)** which clears up much confusion on the mark of the beast. This opportunity is knocking! Don't pass it up.

[Smyrna Chapel](#)

[In-Depth Bible Studies](#) with Dragnslayer - (Note: this is one of my personal favorite sites...it appears to be "off-line." If anyone can find the correct url, and email it to me, I would be deeply

appreciative. Thanks.)

God Did Not Create Evil, Cold or Darkness:

Romans 1:18 The wrath of God is being revealed from heaven against all the godlessness and wickedness of men who suppress the truth by their wickedness, **19** since what may be known about God is plain to them, because God has made it plain to them. **20** For since the creation of the world God's invisible qualities--his eternal power and divine nature--have been clearly seen, being understood from what has been made, so that men are without excuse. **21** For although they knew God, they neither glorified him as God nor gave thanks to him, but their thinking became futile and their foolish hearts were darkened. **22** Although they claimed to be wise, they became fools.

Conversation:

1 Peter 3:14 But even if you should suffer for what is right, you are blessed. "Do not fear what they fear ; do not be frightened." **15** But in your hearts set apart Christ as Lord. Always be prepared to give an answer to everyone who asks you to give the reason for the hope that you have. But do this with gentleness and respect, **16** keeping a clear conscience, so that those who speak maliciously against your good behavior in Christ may be ashamed of their slander.

The Shepherd's Chapel,
Pastor Arnold Murray

frank@germano.com



[[Christian Links](#)]



E n d

Prior historical works of

International Turbine And Power, LLC (1999 - 2003)

Frank Germano, Martin Dorantes, Tad Johnson and Guy Letourneau, P.E.

Functional Tesla-type turbines

Click on the thumbnail pictures for larger viewing.

Functional Tesla Turbine (the "BDT" - bladeless disk turbine) on location: operative medium - Propane Combustion. The pictured Tesla-type turbine and the pictures of its assembly components depict our "third-generation" designs. This BDT Tesla-type turbine can be run on combustion (propane, methane, hydrogen, etc.) steam, water powered, or from compressed air. Tests have been run from combustion, steam, compressed air and water. To date, the turbine has been fully operational since October of 2000, running without any component failure.

This BDT features 304 Stainless Steel construction, throughout, magnetic shaft seals, ceramic high-speed bearings, and Stainless Steel Casing. Total weight of the unit is 104 pounds, including mounting and Combustor. A variable inlet geometry is used allowing true multi-fuel operation. Maximum rated RPM is 18,000. Total maximum HP is approximately 130 SHP. Disk diameter is 10" with 29 primary active disks, plus two tapered end disks. Static labyrinth seals are used for internal case-to-rotor exhaust sealing. For engineering performance figures, see below.



Internal Components of ITP's Tesla-type Turbine - the "BDT", below:



CAD renderings of the Delta-type Tesla Turbine, below

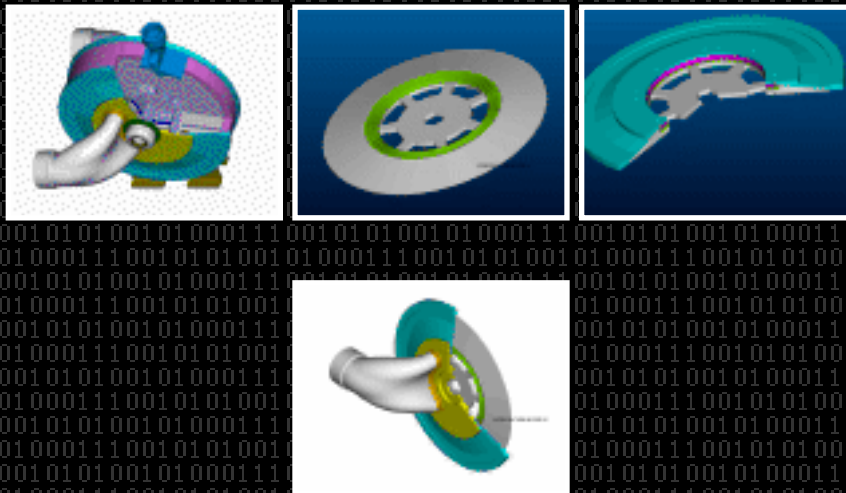

For full disclosure on the Centrifugal Molecular Implosion Turbine (CMIT) please contact us. No representation will be posted on this website, as it will interfere with our potential patent applications and hinder its development.

Engineering Report and Performance Figures



Historical perspective - our BETA, CHARLIE, and Early DELTA series turbines, below. All units are fully functional. These picture represent only a small sampling of the units we have designed and worked on to date, and are offered as a taste of what we can design for qualified individuals and companies. No other company to date has built as many successful, fully operational Tesla Turbines as Frank Germano and International Turbine And Power, LLC



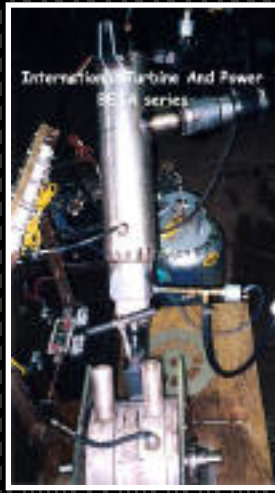

**International Turbine And Power, LLC
931 Rumsey Avenue, Box 550
Cody, Wyoming 82414**

The corporate entity of International Turbine And Power, LLC has ceased operations, effective as of August 2003.

Copyright 2002/2003 No figures or pictures may be copied or otherwise used without explicit permission!

[Return To Index](#)

[HOME](#)

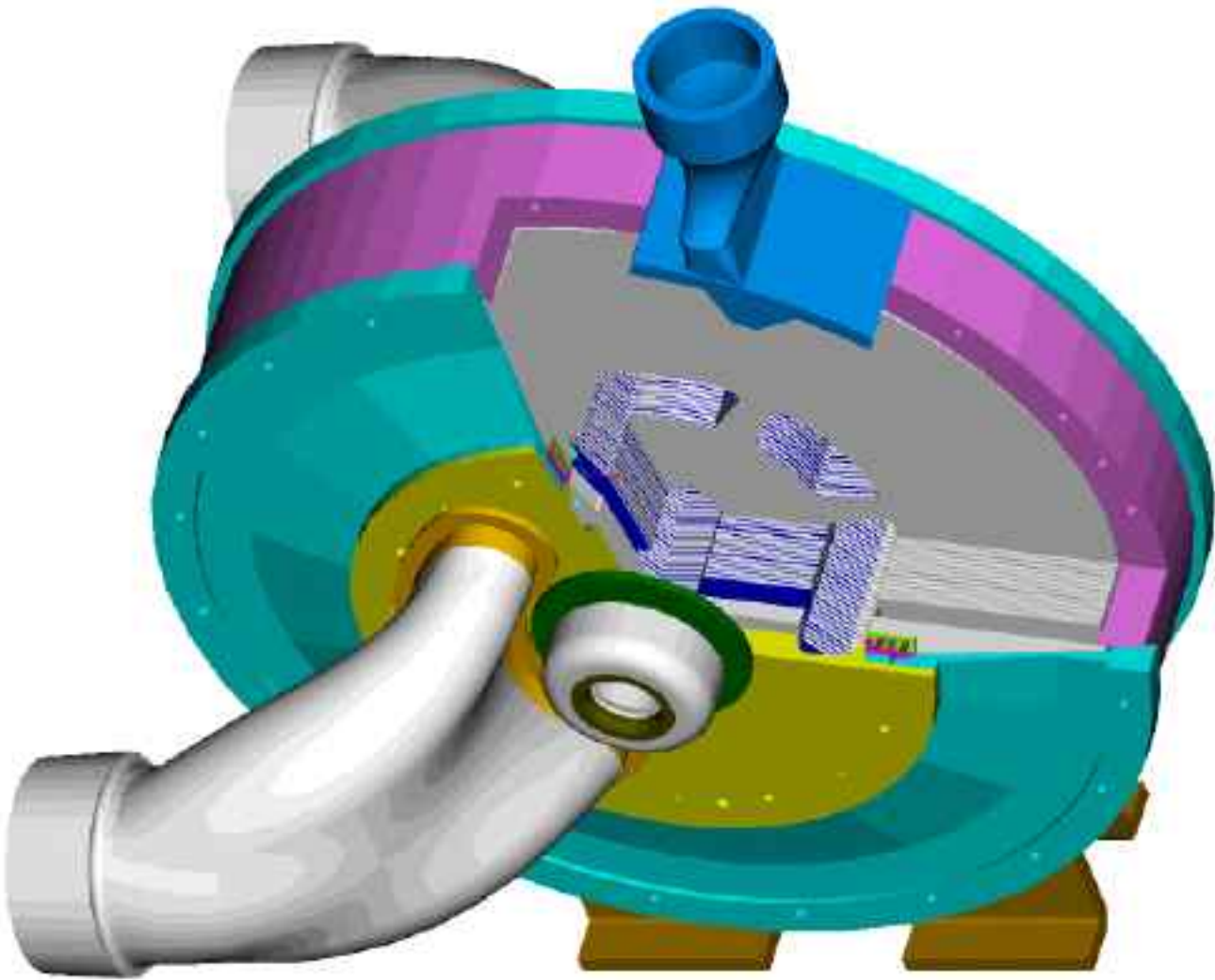

The Tesla/Schauberger based Bio-Airship, Bio-Submarine, and the Biosphere Blimp

Frank Germano (President of the former International Turbine And Power) proudly presents a view of aerial transportation of the future, and submersible technologies. All concepts are complete, self-contained crafts, and with the technology at hand, can be built today. Click on thumbnails for larger view of each rendering; all renderings provided by our good friend, Mr. Frank Chase.

The Airship (blimp) - helium filled superstructure, outboard control pods, and internal vortex accelerating Bladeless Disk power system



The Schauburger based **BioSubmarine**:



The True Airship: Schauburger based propulsion system, internal vortex accelerated thrust, outboard mounted control pods, internal structure, with luxury cruise appointments. Top speed, 240 knots, approximate @ 10,000 feet. 571 feet length; 145 feet diameter.

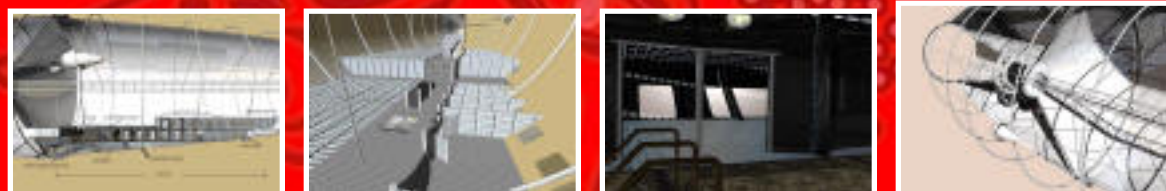

Some history of the design of our crafts:

For commercial and industrial aerial transportation of goods and products, Frank Germano has designed an economical system that incorporates Schauberger and Tesla ideas - we start with a large, helium-filled, aluminum structure; a "blimp" (much larger than the blimps of the recent past - This blimp is shaped in the form of an elongated egg. (see the book "[Living Energies](#)" by Callum Coats - a detailed description, foundation and history of the theories of Viktor Schauberger for a complete description as to "why" we chose this shape)

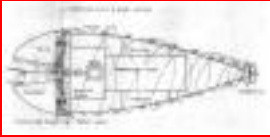

At the frontal section is an intake area opening, which draws in the atmospheric air, which is accelerated via a BDT Tesla-type hybrid system (click on image - left - for a detailed drawing of Viktor Schauberger's original concept for a submarine design.)

This super-accelerated and pressurized air is now forced out slits in the forward third sides of the blimp (think of a fish's gills), and the now de-oxygenated, pressurized, velocitized air forms vortices along the sides of the blimp, allowing for reduced friction and a "slip" effect as the craft travels through the air. This is an application of our "InVAID®" technology to its fullest. A high degree of mobility is thus afforded, and the craft is capable of lifting an incredible amount of tonnage (products and goods), and traveling at unbelievable speeds approaching 250 knots. Additional outboard pods, fitted with smaller BDT propulsion systems are installed in several location around the craft offer a high degree of directional control and stability in any weather or conditions, particularly effective for maneuvering and landing the craft.

Having only done basic, preliminary calculations, this system, when adapted to carry freight (commercial and industrial shipping applications) would drastically cut and lower the cost of shipping products from and to overseas markets. This system is not only more cost effective, in terms of the cost of the shipping, itself - it would also save "time" (drastically faster than any ship or tanker/carrier; 250 knots vs. 25 knots max with a standard ocean transport ship) - it is also immune to changes in weather or ocean storms.

This craft can easily be designed to carry passengers, and could be outfit for luxury cruises continentally. Imagine going back to the days of yore, and floating silently in the lap of luxury over the continents or the Earth's oceans...blimp travel was once considered to be the most luxurious way to travel - it could be so again. With the abundant supply of relatively cheap helium gas, and the speed afforded by our Tesla-type systems, this could become the wave of the future. Investors are welcome to contact us and we will present a thoroughly detailed plan for this system of transportation.



This exact process and design can be utilized in submersibles, as well. This creates some unique possibilities in regards to ocean-going transportation. Since the craft would now operate under the water's surface, it would effectively be mostly immune to weather conditions on the surface. Speed would be greatly increased over standard ship's ocean surface speeds, as well. Initial renderings provided by Frank Chase.

Who would we love to see interested in this application? For starters, Mr. Richard Branson (Virgin Mobile, Virgin Air Lines, Virgin Records creator)...he has already shown his daring and interest in around-the-world balloon flights...why not get active in Air Ship technology?! Also, "The Donald" - Mr. Donald Trump. With his accute business sense, and his now more-than-ever notariety with his hit TV show...could you imagine a floating Trump Casino in the sky - talk about luxury and out (or rather - above) this world status!!! Come on in, Mr. Trump. The sky could be yours...

Viktor Schauberger's Biological Submarine - originally appearing in "KeelyNet" 03/25/02

From Journal Of Borderland Research - Sep/Oct 1990, page 9.

The biological submarine once had the attention of the German War Lords, but Viktor Schauberger made it look as though it were not very useful, as in his opinion, bio-technology is for supporting progress and not for destruction. This submarine idea was taken from the observation of fish, especially of trout, which can stand motionless in a flowing stream, just by taking water in and out.

This process has two functions, first it creates a vacuum in front of the mouth into which the fish gets sucked, and at the same time provides food, as the water contains all that the fish needs. While the food goes into the digestive system, the water is forced through the fan-like structure of the gills, which not only absorb the oxygen needed, but also push the water backwards. This specially compressed water does not mingle right away with the rest, it glides along the conical body like a wedge and shoves it forward. In addition, on the scales it forms little whirls which enhance the push further.

However, Viktor Schauberger was not the sole observer of this phenomenon. Before him others not only formed the same idea but even constructed prototypes with some results. One inventor, A. Borner, came to the conclusion that the speedy motion of the fish is relative to the size of its gills. He constructed a boat with a precise opening in its bow, where a turbine sucked in water like a fish, and pushed it out through slit-like exit ports in such a way that it glided along the hull like a sheet, not only separating it from the friction of the outside water, but also giving it an additional push forward.

Further, he applied skin depressions like sharks have on his ship's hull, presuming that they cause small swirls, and so increased the forward motion. Borner even incorporated the slippery skin layer that fish have by applying oil to the hull to reduce friction. He hoped all this would bring a 60-80% reduction in fuel. Indeed, experiments with his boat FORELLE, meaning 'trout', achieved twice the speed, while still using the same amount of fuel. Apparently, Borner did not know about the spiral-vortex, which is an invention of Viktor Schauberger. If properly applied, it will not only increase speed, but also reduce fuel consumption to a minimum!

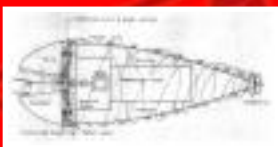

The drawing (left) by **Dipl. Ing. Walter Schauberger**, Viktor's son, shows such a submarine. His bio-technical submarine has a moveable bow, which gives the boat the flexibility fish have. The conical and rifled (rippled) water-intake permits a variable step-up, creating a strong torque on the water, which, after entering the implosion turbine, will be intensified to such a pitch, that now its recoil (resonance) is driving it instead of the motor, as bio-technical applications always have a pull and push action. Such a turbine consists

of tapered-down pipes with inside rifling which are bent into spirals. Such FREE ENERGY is not a question of time, rather the will to USE IT, as it already exists, giving us a chance to move on water, under it and in the air using only a fraction of the energy we use today! Click thumbnail to enlarge image.

We've taken the time to "modernize", if you will, Viktor's craft, and come up with both the Bio-Technical Submarine, and the Bio-Airship - click the thumbnail images, shown throughout this page for a larger view. Both operate on the same principals set forth in Viktor's patent - with the exception of using our Bladeless Disk systems as the propulsion: renderings provided by our friend, Frank Chase.

Thanks for your time; investor input is always welcome!

Frank Germano

Bladeless Disk, Vortex And Implosion Technologies

[HOME](#)

[SITE INDEX](#)

[COMPANY HISTORY](#)



[home](#)

[manage my account](#)

[webmail](#)



Whoops!

The file you were looking for on **www.frank.germano.com** was not found.

With over 15,000 popular names like Daniels in our library, we're sure to have the perfect email and web address for you.

search for your name

@

or, search for a different name

[» Go](#)

consider the benefits

- » Register Domain & Email Address for \$29.95 or Email Only for \$24.95 / yr.
- » POP, Webmail, Forwarding, No Spam, No Taglines.
- » Add Enhanced Features such as IMAP, Storage, Web Hosting and More.



[\[support \]](#) [\[contact us \]](#) [\[about \]](#)

© 2000 NetIdentity 350 South Center Street, Ste. 500 Reno, NV 89501

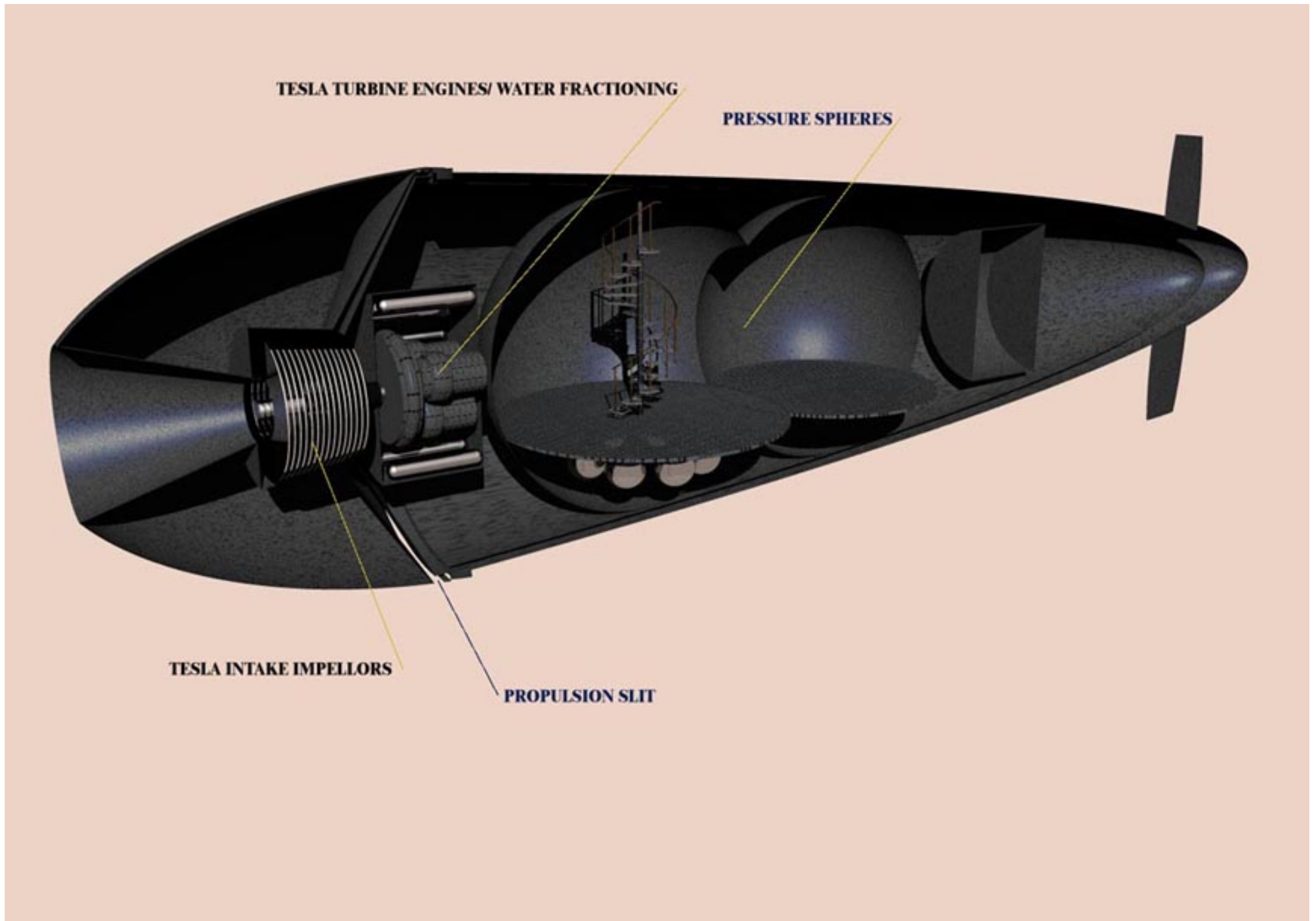

Frank Germano; Tesla & Schauberger Technologies

Bladeless Disk, Vortex & Implosion Technologies

By Frank Dominic Germano

Background:

The world's appetite for affordable energy continues to grow. Advanced economies can afford to impose strict environmental standards and either pay to import a substantial portion of their clean energy requirements or use technology to clean their indigenous energy resources. However, economic growth in developing countries is often powered by fuels produced using readily available, low-quality, indigenous energy resources (e.g., sub-bituminous coal, brown coal, lignite, peat, wood waste). As the quality of the world's environment becomes an increasing concern, there is international pressure to implement stringent environmental standards worldwide. This will require new technologies and processes that will upgrade low-grade energy resources to efficient, clean-burning fuels.

There is a vast market potential for technologies that convert low-quality energy resources to high-quality energy products. In order to meet the requirements of the United States Clean Air Act of 1990 within the next 10 years, there will be a 100 to 150 million ton per year market for compliance coal in the United States that serves power generation and industrial facilities where emissions are not scrubbed. This market is equally impressive abroad; total world coal consumption in 2010 is forecast at 7.5 billion tons per year, 80 percent of which will be used outside the United States. Additionally, the world market for renewable resource fuels (e.g., bagasse, biomass, municipal solid waste, sludge, wood waste) is rapidly expanding as users recognize that renewables have significant benefits that can result in long-term lower cost service, less environmental degradation, and reduced risks.

Over the past six years, Frank Germano, Guy Letourneau, P.E., Tad Johnson, and Martin Dorantes [(formerly with) "International Turbine & Power, LLC" (ITP)] has positioned itself for a role in the emerging worldwide market for solutions that enhance energy output and preserve the environment. The world's appetite for affordable energy continues to grow. Advanced economies can afford to impose strict environmental standards and either pay to import a substantial portion of their clean energy requirements or use technology to clean their indigenous energy resources. The problems to date have been dealing with "how" to harness and use these energies in the most effective and cost-conscious manner. Enter **Frank Germano - "InVAID Induced Flow Systems"; Bladeless Disk, Vortex & Implosion Technologies** - with our *Bladeless Disk Technology* ("BDT"), *Implosion* and *Vortex Technologies* ("InVAID", and "FreshCool" systems) - we can effectively utilize

these improved fossil fuels and natural resources to the fullest.

As a technology and marketing company, **Frank Germano, of Induced Flow InVAID Systems** manages the affairs with a minimum of full-time staff. The Company believes that the best management approach at this time is to utilize consulting, subcontractor and strategic partner alliances to supplement its management team and qualified board of directors, who also bring diverse resources from which to draw. This approach allows access to highly skilled individuals who would not be available as employees and organizations that cannot fully dedicate their resources to. It also keeps fixed costs under control. **Mr. Frank Germano** resides near the shores of Lake Wallenpaupack, in north-eastern Pennsylvania. Frank handles the daily corporate business affairs, as well as leads the scientific design programs. Germano is now forming the new company based on designing and creating systems using the revolutionary concepts and ideas of **Viktor Schauburger** and **Nikola Tesla**; "InVAID Systems" - Initiated Vortex, Accelerated Implosion Drive - "Induced Flow InVAID Systems."

The applications listed below could be implemented with very little investment monies. All technologies presented are systems that we have previously worked on in depth. All applications are also "Earth-Friendly" and would present an enormous advance in pollution free power generation. We can provide the technology; we only await the necessary funding from investors that are far-sighted enough to realize the implications of what will happen if we DON'T do something soon.

APPLICATIONS

STEAM POWER; Geothermal And Solar Powered systems:

The **BDT** (Bladeless Disk Turbine), powered by steam, generated from a solar intensifying system, is an answer to "free" energy...Steam drives the BDT, which runs a generator, supplying electricity... a Tesla-type pump re-circulates the water supply...the initial cost of the equipment is minimal, owing to the relatively low cost of the units. Also, this is steam driven system...which equates to zero pollution, and it is 100% "off - grid" (no need for the electric , or gas companies, here!). An added benefit of such a system is the ability to desalinate water, thus, the system, by its very nature, provides clean and pure drinking water.

Almost a quarter of the air pollution today comes from the coal being burned to generate electricity. Fuel consumption, resulting in air pollution and acid rain, could be significantly reduced simply by replacing the conventional blade steam turbines currently used by utilities with the Bladeless Tesla Steam Turbine (BDT). This also would have the added bonus of drastically reducing maintenance. But the *real solution* lies in using low temperature wet steam occurring naturally from the ground in the form of **geothermal energy**. This energy would destroy a conventional bladed steam turbine, unless expensive steam drying is employed. **However, the Bladeless Tesla Steam Turbine (BDT) requires no drying and can be connected directly to the geothermal source.**

It has been estimated that the geothermal potential in just Southern California alone, could power the entire North American Continent with NO POLLUTION! Add to this the large geothermal potential of Wyoming (think of the geysers in "Yellowstone National Park" - that's geothermal energy), Oregon, Washington, Idaho and Montana, and you will begin to get the picture of the enormous geothermal potential available in the Northwestern states alone. Large oil companies have comprehended the potential of geothermal energy and have purchased many of these large tracks of prime geothermal land. Due to the revolutionary concepts embodied in this engine, we can easily end the so called energy crisis and dramatically reduce pollution. Even the vested energy interests are beginning to understand that now is the time for change, realizing their future health and wealth is directly linked to that of the environment. Environmentally sensible usage of available resources - "some fresh air for a dying planet"; Germano's credo.

This system, when adapted for Geothermal heat sources, is quite probably the finest example of clean, non-polluting "green" power ever made available and offered commercially. The Tesla-type system needs no other alterations to take full advantage of geothermal steam sources. Whether coupled directly to the steam source, or if water is fed down via piping into the earth and the super-heated steam returning is used - **Our** systems can take the condensate or the steam directly, with no dehydrator connected. Yes; that statement is correct - our turbines can run through the entire adiabatic cycle (from water condensate to steam to super-heated steam and back to water) without any damage to our units. In fact, there are numerous advantages of allowing the turbine to run in a water saturated state. The incredible fact is that there are so many spots on the planet that can provide geothermal steam that we NEVER even had to use fossil fuels to generate electricity. This system is a totally non-polluting, sustainable, ecologically sensible electrical energy production solution.

Home Power Generators; portable and stationary

With the BDT engine coupled to a generator (50, 75 or 100 KW), your home or small business becomes the utility. After installation, whenever your home's electrical needs fall below the unit's rated output level, the surplus electricity is SOLD back to the utility company; in essence, they send YOU a check in the mail. The BDT runs on propane or natural gas (where available), or hydrogen gas, diesel, or standard pump gasoline. The BDT engine utilizes this gas as fuel to provide electricity for power for your house or small business. The emissions produced are rendered virtually contaminant free, due to our revolutionary combustion process. With electricity being produced on-site, transmission and distribution costs are reduced or eliminated, and both economic and environmental benefits are achieved. As a bonus, surplus power could be sold into the electrical grid, further improving the overall economics, as stated earlier. In our portable models, you can take your "power" with you, which is great for contractors, or second/vacation homeowners. These units are maintenance free, extremely quiet, efficient, and, with the prices of natural gas and propane (currently), the cost of operation is about one half that of using electricity from the utility grid source. The units can also be used as a back-up power generator, if utility grid connection is maintained.

After the events of August 14th and 15th, 2003 and 50 million people in the north eastern United States being left without electricity, we should become seriously aware of our waning electrical utilities ability to provide uninterrupted service. With the BDT power units being installed at your location, your electricity needs are guaranteed. These systems would also allow for "buffering" the utilities companies' lines - the units are designed to sense a potential line volt failure and send additional electricity into the system, thus preventing this situation from happening on a large scale ever again. *This goes without saying that enough of our systems have been installed in a given area.

LANDFILL SITES; Methane Powered, Electricity Generating Systems:

As urban populations grow, the treatment of the mass amounts of residential and commercial waste, often referred to as "the bio-mass" becomes increasingly difficult. Landfill and waste disposal sites generate methane gas through the natural process of biodegeneration. The handling of this low grade gas is a problem to municipalities and it is normally vented to the atmosphere. The BDT engine can efficiently burn this poor quality methane as fuel and in doing so reduces harm to the air quality as well as producing a revenue source - electricity. One of our first units was fully tested "on-site" in New Jersey, proving our claims, are, in fact, valid. It is entirely feasible, and practical to use Methane gas from landfills to supply the gas to drive a Bladeless Disk Turbine (Tesla Turbine). Considering the vast amount of refuse (waste) being dumped in the United States, and considering that this waste is useable, it would be a folly to simply let this "free" source of energy go untouched. With the abundance of landfill locations, and the methane gas that could be captured (the process of natural decay of waste matter), we could quite easily

meet our electrical needs simply by installing Tesla Turbines throughout each landfill and use the methane gas to fire high-efficiency combustors. The turbines would drive either DC or AC generators.

AGRICULTURAL AND FEEDLOT:

It has been recognized for decades that the livestock industry is a major contributor to global bio-waste. Mid and large size operations produce significant amounts of greenhouse gases, mainly from the breakdown of animal manure. This is a waste fuel source that Bladeless Disk technology can utilize and return multiple benefits to both the ranchers and the environment. Feedlots and farms consume electricity and are always looking for ways to reduce expenses.

WATER POWERED, ELECTRICAL GENERATION:

By utilizing the BDT engine, and the BDP® Tesla-type Pump with the theories of [Victor Schauburger](#) (Vortex theories), we have a truly nonpolluting, free energy source...simply divert the path of a river's flow, accelerate it by using our "InVAID®" technology vortex generator, and "tap" the potential energy of "living water" with the Tesla engine. This system can be built to any commercial size necessary, with an almost limitless power output, dependant only on the available water flow and energy available. What exactly are we talking about here? Take ANY flowing body of water, i.e. large river, anywhere in the United States or the world in general (for that matter), and, without building any dam or creating any reservoir, we can, through specific design, create a vortex-generating structure in the active water flow (a concrete reinforced structure that "aims" the water into a specially designed vortex generator - a funnel - which will then accelerate the water into a special type of Tesla Bladeless Disk Turbine). No environmental impact, no unsightly dams or reservoirs, no damage to the wildlife, no loss of acreage. This technology is available NOW. By simply using several of the available rivers in the United States, alone, we could easily supply all of our current electrical needs - all without ANY pollution. Free energy? Not quite, however, it's about as close as we are going to get. Non-polluting energy derived from an abundant supply of flowing water. Endless? Yes...as long as the water flows, there will be enormous power generated.

Another fascinating area of research and application is for supplying useable amounts of electricity to rural areas that would otherwise be considered too costly for utilities to run standard electric lines to.

REFRIGERATION & AIR CONDITIONING SYSTEMS:

"As an air compressor it is highly efficient. There is a large engine of this type now in practical operation as an air compressor and giving remarkable service. Refrigeration on a scale hitherto never attempted will be practical, through the use of this engine in compressing air, and the manufacture of liquid air commercially is now entirely feasible." (Nikola Tesla, 1911)

We could not have stated it better. Through the use of the **BDT**, coupled to a **BDP** Tesla-Type Pump, with a condenser between, we have quite probably one of the most efficient form of air refrigeration ever invented, and, without the need for harmful, environmentally 'unfriendly' gasses, Freon or otherwise. This system is also reversible, forming our patent pending "**Fresh-Cool®**" heating/cooling technology. When adapted to industrial, commercial, or home markets, as a "heat-pump" system - it is without equal. The electrical energy consumption alone makes it a very attractive alternative to conventional technology. Without incorporating a compressor stage (which ALL conventional systems must use), the BDT Tesla-based heat pump can cut more than 3/4 off your present electric bill. This is a conservative estimate. We are currently coordinating efforts to install these air-to-air Conditioning systems in several large commercial facilities. As an air compressor, the BDT/BDP-type units are without equal, both in their performance, and their cost of operation. As a pumping application, one such pump now in operation, with eight disks, eighteen inches in diameter, pumps four thousand gallons a minute to a height of 360 feet. Try accomplishing that task with a conventional pump of similar size. As an air blower or fan replacement, the Tesla Pump or our BDP are without equal. A simple fact - fans are inherently "noisy" due to the fan-blade "shearing" through the air, causing violent disruption of the air medium causing sound wave emissions. Bladeless Disk systems are inherently quiet, causing no disruption to the airflow other than its rapid movement. In the same space now occupied by a conventional fan (bladed) system, our systems can easily triple or quadruple the amount of air movement. Replacement fans, and blower replacements are just a few of the applications where Bladeless Disk Technology would be beneficial.

**INDUSTRIAL AND COMMERCIAL AIR TRANSPORTATION;
Luxury Cruises, Fire-Fighting, Industrial Cargo Carrying, Tourism
Industry:**

For commercial and industrial aerial transportation of goods and products, Frank Germano has designed an economical system that incorporates Schauberger and Tesla ideas - we start with a large, helium-filled, aluminum structure; a "blimp" (much larger than the blimps of the recent past - This blimp is shaped in the form of an elongated egg. (see the book "[Living Energies](#)" by Callum Coats - a detailed description, foundation and history of the theories of Viktor Schauberger for a complete description as to "why" we chose this shape)

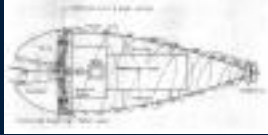

At the frontal section is an intake area opening, which draws in the atmospheric air, which is accelerated via a BDT Tesla-type hybrid system (click on image - left - for a detailed drawing of Viktor Schauberger's original concept for a submarine design.) This super-accelerated and pressurized air is now forced out slits in the forward third sides of the blimp (think of a fish's gills), and the now de-oxygenated, pressurized, velocitized air forms vortices along the sides of the blimp, allowing for reduced friction and a "slip" effect as the craft travels through the air. This is an application of our "InVAID®" technology to its fullest. A high degree of mobility is thus afforded, and the craft is capable of lifting an incredible amount of tonnage (products and goods), and traveling at unbelievable speeds approaching 250 knots. Additional outboard pods, fitted with smaller BDT propulsion systems are installed in several location around the craft offer a high degree of directional control and stability in any weather or conditions, particularly effective for maneuvering and landing the craft.

Having only done basic, preliminary calculations, this system, when adapted to carry freight (commercial and industrial shipping applications) would drastically cut and lower the cost of shipping products from and to overseas markets. This system is not only more cost effective, in terms of the cost of the shipping, itself - it would also save "time" (drastically faster than any ship or tanker/carrier; 250 knots vs. 25 knots max with a standard ocean transport ship) - it is also immune to changes in weather or ocean storms.

This craft can easily be designed to carry passengers, and could be outfit for luxury cruises continentally. Additionally, the craft could easily be outfit to fight fires. With the enormous lifting potential of lighter-than-air crafts, the units would be ideally suited to carry water or fire-retarding materials and could easily be maneuvered over large land-based fires and drop their load on target. For personal transportation, imagine going back to the days of yore, and floating silently in the lap of luxury over the continents or the Earth's oceans...blimp travel was once considered to be the most luxurious way to travel - it could be so again. With the abundant supply of relatively cheap helium gas, and the speed afforded by our Tesla-type systems, this could become the wave of the future. Investors are welcome to contact us and we will present a thoroughly detailed plan for this system of transportation.





This exact process and design can be utilized in submersibles, as well. This creates some unique possibilities in regards to ocean-going transportation. Since the craft would now operate under the water's surface, it would effectively be mostly immune to weather conditions on the surface. Speed would be greatly increased over standard ship's ocean surface speeds, as well.

Initial renderings provided by Frank Chase. I truly wish that **Mr. Richard Branson** (Virgin Air Lines, Virgin Records, Virgin Mobile creator and avid balloonist!) would take an active interest in this particular application. We could do some amazing things with these air ships. Mr. Branson - are you listening?! If someone reading this webpage knows how to contact Mr. Branson, please feel free to do so on my behalf. You would gain my eternal gratitude for doing so. The only other person I would guess might be interested in this might just be **Mr. Donald Trump**. Tourism on an unheard of level - or - luxury **Casinos in the sky**...what a way to fly! "The Donald" might just also be interested and the same goes for contacting him regarding this exciting technology.

HELICOPTER RETROFITS:

This system simply replaces the standard rotors on an existing helicopter with our Tesla-type disks. These disks are contained underneath and inside of a specially designed "Frisbee" shaped, lightweight unit. The incredible thrust developed by the Tesla bladeless disk system is re-directed by the "Frisbee" shaped shroud, and is forced downward. At the same time, the incoming air from above, is sucked so violently into the system that a vacuum is created above the craft, enabling an almost amazing amount of lifting forces to be generated. The advantages of this type of system are obvious - the helicopter with no other modifications than those mentioned above, now has approximately 10 times the lift capacity, and is now capable of almost any forward velocity (dependant on its thrust capability - it can easily go to MACH speeds, if so designed!).

Honestly, *I truly wish a government representative or military official would contact us for more details on this amazing application. This system will radically alter the way helicopters could be used in the modern warfare arena.* The advantage of this type of system is quite obvious vs. conventional bladed technology. Without any further modifications, the new "X-Plane" from Lockheed (or the losing prototype from Boeing) could easily be outfitted with a Tesla-type BDT. What would this do? In relatively the same physical space now occupied by the conventional bladed lift (thrust) impellor, almost five times the lift would be realized by switching to our type of system. Not too bad...if only one of these companies would listen.

NANO & MICRO TURBINES; micro-sized engines/generators

Owing to the relative simplicity of our BDT engine's design, and the drastically lower production costs, it is inevitable that the BDT-micro engine will surpass and replace all existing "micro" engines and pumps. The application of this technology will be rapid and direct. Two areas where we can immediately compete are in the laptop computer and hand-held power tool battery replacement markets. This is also an environmentally responsible application (the replacement of batteries that would otherwise end up as landfill waste and contamination of the ground-water base with harmful battery acid products). There is virtually no limit, other than available technology itself, to the micro size of the engines that we can build for these applications.

An engine smaller than the size of an average postage stamp or shirt button and ¼ inch thick, fueled and fired by our revolutionary combustion process (running on propane or butane) could easily replace the bulky battery packs of most hand-held tools, with this same unit driving the power for your laptop computer. Another area of importance will probably be in the space/satellites arena where weight savings are tantamount. ***We are currently seeking interested parties for either joint venture partnering or direct investment funding for this technology development. [Please contact us for full details.](#)***

AUTOMOBILE COOLING SYSTEM PUMP:

These are four inch diameter water pumps. It is specifically designed to pump cooling water for internal combustion engines of all sizes and types. It has an inch and a quarter inlet and a one inch outlet. It will pump approximately 1,000 gallons of water per hour at 12 PSI. It is driven by a flat pancake type D. C. motor that is only 1/2" thick. It's power requirement is 100 watts. The pump itself is fabricated from 6061 aluminum, hard anodized, which is equivalent to a type of stainless steel that is capable of going through a 200 hour salt spray test. The bladeless pump can pump boiling water without cavitation without losing its prime. Conventional pumps cannot pump boiling water, leading to engine damage if the cooling system does reach the boiling point. This will allow a new type of cooling system for automobiles that will replace the belt driven water pump. The electric motor that drives this pump will not operate when the temperature of the engine indicates that it is not required. The pump will only operate when it is needed. The operating temperature can easily be adjusted in the field from 180 degrees to 200 degrees without having to replace a mechanical thermostat as is the normal procedure. The conventional lifting surface centrifugal pump that is normally used requires from 6 to 10 HP to drive it off a belt. The new bladeless pump will operate only when needed and then consumes less than one HP. Another example of reduction of parasitic horse-power. This pump is currently not available for commercial sale but has been fully tested and awaits investment funding. This same pump could easily be retrofit for use as a power steering pump, similar in design to the "Cybrid" power steering system used by Subaru in their XT6 line of cars...***Anyone from the "big-three" automobile manufacturers out there listening?!***

HYBRID ELECTRIC DRIVE VEHICLE TECHNOLOGY:

This system is just plain simplicity in itself. Owing to the extremely efficient operation of our Tesla-type engine, the BDT, the engine is coupled to a high-speed electrical AC generator. Any type of combustible fuel may be used to drive our turbine such as methane, butane, diesel, gasoline, or hydrogen (preferable). The BDT drives the generator and supplies the necessary power to drive an electric AC motor. Classic regenerative braking is used to re-charge the battery packs, which are also in continuous charge via the BDT when heavy loads are not encountered. On low-load driving, the BDT simply "idles" and, owing to its "stingy" fuel use, a ridiculously high MPG is achieved. ***Tesla stated long ago (1933 to be exact) that he could retrofit a standard auto of the day, and, using his Tesla Turbine, and an AC generator (of his own design) and an AC motor - drive from New York City, NY to San Francisco, CA on one 20 gallon tank of gasoline! Can we duplicate that feat? Yea...I think we can. IF hydrogen is used as the fuel source, the condensate is recaptured, and the outlet of the BDT itself, is - get this - water vapor! Yep...this one is a no-brainer. Again, is anyone from Detroit out there listening?!!!***

- [!\[\]\(95b42f0077faf7439a26242a54e021ec_img.jpg\) Researching A Shockwave Tesla Turbine](#)
- [!\[\]\(e097ab4c08b8186dd0908330bbc2dc28_img.jpg\) A Thermo-Pneumatic Tesla Turbine Locomotive](#)

PUMPING APPLICATIONS:

We can design pumping systems which can handle the most demanding pumping conditions. **One such pump now in operation, with eight disks, eighteen inches in diameter, pumps four thousand gallons a minute to a height of 360 feet.** Try accomplishing that task with a conventional pump of similar size. Owing to the fact that the bladeless pumps can work effectively pumping virtually any fluid or gas, they can easily be built to any performance level required. One of the most intriguing areas is in the Ocean dredging applications. Current technology is woefully ineffective. By using a bladeless disk pump, unbelievable efficiencies with ocean-bottom sand removal and relocation could be attained. The pumps are self-priming, and by the action inherent in the pumps themselves - boundary layer adhesion and viscous drive - minimal contact with the internal disks occurs, thus enabling operation where other pumps would quite simply fail. Here is just a **sampling** of the conditions where our Bladeless Disk Pump can operate:

Pharmaceutical and Medical Industry: living cells and human blood cells; plankton; bacteria. New, highly efficient and totally reliable heart replacement pumps, again, with no damage to the living cell.

Agricultural Industry: agricultural sludge and slurries; fertilizer and salts, both liquid and dry; pumping of fruits & vegetables in water without damage.

Ocean bottom dredging; Sea-bottom "**treasure hunting**" applications; Sand-bar removal & relocation, high-pressure water-jet cutting and drilling. We would love to be part of your next treasure hunting adventure, and can design superior systems that would aid you in all ocean-floor recovery operations. For coastal areas, we can design systems that will not only cost less than current dredging operations - our systems will operate without failure,

and remove virtually all sediment, sand, aggregate and the like, **without clogging**, and move it in incredible volume to the site of your choosing. With our knowledge of Viktor Schauberg's ecological and environmental studies, we can easily recommend solutions for beach replenishment that will drastically alter current trends and provide stunning results. In the same process, as stated above, we can easily design wave-powered electrical generation systems that will provide continuous power for your community during the same operation.

Municipal Water Transport and Water "Re-vitalizing." :Simply by replacement of conventional types of pumps with our Bladeless Disk Pumps, an enormous savings in electricity use costs can be realized due to the efficiencies inherent in the Bladeless Disk Pump designs. There is also a savings associated with "zero" maintenance costs (only one moving part, and virtually no wear). along with the substantial improvements in cost of operation, we can provide specially designed piping, which incorporate our "whorle-pipe" fittings which induce a vortical flow inside of the pipe itself, forcing the water to for spiral vortex flows - the greatly reduces, if not eliminates, all sediment build-up inside the pipes, and greatly reduces inner pipe wall friction and accelerates the flow. Our systems can be designed for commercial as well as household use. Contact us for further details.

***As stated in many different locations on this site and webpage, all of our units are in the prototype stage! However, until qualified, interested investors (Angels, VC's or corporate funded entities) are located, and investment monies applied, commercial availability of these units is still some time away. The cost for each of these units and systems is, therefore, based on applying our *standard engineering fee* (\$165.00 per hour for design services) plus the individual cost of manufacture, shipping and installation.**

**** For qualified individuals and investors interested in making a commercial release feasible and profitable, please see below for further information.**

**CLICK HERE FOR MORE INFORMATION ON THE HISTORY OF NIKOLA TESLA'S
BLADELESS DISK TURBINES AND PUMPS.....**

Contact Frank Germano by email

**Hydroelectric Power
Turning water's mechanical energy into electricity**

Since the time of ancient Egypt, people have used the energy in flowing water to operate machinery and grind grain and corn. However, hydropower had a greater influence on people's lives during the 20th century than at any other time in history. Hydropower played a major role in making the wonders of electricity a part of everyday life and helped spur industrial development. ***Hydropower continues to produce 24 percent of the world's electricity and supply more than 1 billion people with power.***

Evolution of Hydropower

The first hydroelectric power plant was built in 1882 in Appleton, Wisconsin to provide 12.5 kilowatts to light two paper mills and a home. Today's hydropower plants generally range in size from several hundred kilowatts to several hundred megawatts, but a few mammoth plants have capacities up to 10,000 megawatts and supply electricity to millions of people. Worldwide, hydropower plants have a combined capacity of 675,000 megawatts and annually produce over 2.3 trillion kilowatt-hours of electricity, the energy equivalent of 3.6 billion barrels of oil.

Hydropower in the U.S.

With a capacity of more than 92,000 mega-watts— enough electricity to meet the energy needs of 28 million households—the U.S. is the World's leading hydropower producer. Hydropower supplies 9 percent of the country's electricity and accounts for 49 percent of all renewable energy used in the U.S.

The nation's largest hydropower plant is the 7,600 megawatt Grand Coulee power station on the Columbia River in Washington State. The plant is being up-scaled to 10,080 megawatts, which will place it second in the world behind a colossal 13,320 megawatt plant in Brazil.

How Hydropower Works

Hydropower converts the energy in flowing water into electricity. The quantity of electricity generated is determined by the volume of water flow and the amount of "head" (the height from turbines in the power plant to the water surface) created by the dam. The greater the flow and head, the more electricity produced. This is where the similarity between "conventional" hydro-power sites and our systems ends.

Germano & Dorantes uses a proprietary system based on the works of [Viktor Schaubertger](#) and [Nikola Tesla](#). Our systems do not require dam construction, nor the invasive reservoir thus created. Our systems offer a "zero-impact," environmentally sensible approach to hydro-power electrical generation facilities. We can take any average water flow from a medium to large river, divert part of that flow into a vortex-inducing structure, and capture the water's energy via a Bladeless Disk Turbine.

A typical hydropower plant includes a dam, reservoir, penstocks (pipes), a powerhouse and an electrical power substation. The dam stores water and creates the head; penstocks carry water from the reservoir to turbines inside the powerhouse; the water rotates the turbines, which drive generators that produce electricity. The electricity is then transmitted

to a substation where transformers increase voltage to allow transmission to homes, businesses and factories. Short of the creation of a dam and reservoir, our systems operate on identical principals. However, with our revolutionary system, the beauty of the environment is not disturbed in any way!

Types of Hydropower Plants:

1. **Conventional** - Most hydropower plants are conventional in design, meaning they use one-way water flow to generate electricity. There are two categories of conventional plants, run-of-river and storage plants.
2. **Run-of-river plants** - These plants use little, if any, stored water to provide water flow through the turbines. Although some plants store a day or week's worth of water, weather changes - especially seasonal changes - cause run-of-river plants to experience significant fluctuations in power output.
3. **Storage plants** - These plants have enough storage capacity to off-set seasonal fluctuations in water flow and provide a constant supply of electricity throughout the year. Large dams can store several years worth of water.
4. **Pumped Storage** - In contrast to conventional hydropower plants, pumped storage plants reuse water. After water initially produces electricity, it flows from the turbines into a lower reservoir located below the dam. During off-peak hours (periods of low energy demand), some of the water is pumped into an upper reservoir and reused during periods of peak-demand.
5. **"Vortex Accelerated, Flow Induced Systems" (InVAID®)** - this type of system utilizes the vast energy that is stored in flowing water, acted on by the additional force of a spiral vortex system (a **Viktor Schaubberger design**), which further accelerates the water, at which point it is "collected" by a special type of bladeless disk turbine (of our Tesla based design). This system far surpasses other types in both its cost of installation, its power output, and the "zero-impact" ecologically on the surrounding environment.

Building Hydropower Plants

Most hydropower plants are built through federal or local agencies as part of a multipurpose project. In addition to generating electricity, dams and reservoirs provide flood control, water supply, irrigation, transportation, recreation and refuges for fish and birds. Private utilities also build hydropower plants, although not as many as government agencies.

Benefits:

Hydropower is a clean, domestic and renewable source of energy. Hydropower plants provide inexpensive electricity and produce no pollution. And, unlike other energy sources such as fossil fuels, water is not destroyed during the production of electricity—it can be reused for other purposes. Our systems carry an added advantage - "re-vitalized" water is

supplied at the outlet. For some (presently) unexplained reason, water run through a Schauberger vortex inducing pipe system exhibit revitalized properties, similar to the best deep spring water in characteristics.

Obstacles:

Hydropower plants can significantly impact the surrounding area—reservoirs can cover towns, scenic locations and farmland, as well as affect fish and wildlife habitat. To mitigate impact on migration patterns and wildlife habitats, dams maintain a steady stream flow and can be designed or retrofitted with fish ladders and fish-ways to help fish migrate upstream to spawn. The advantages of our non-invasive systems are quite obvious - ***no dam and no reservoir (!)*** - clean, non-polluting energy, without the invasive dam and reservoir associated with conventional systems. The run-of-the-river is maintained, as is the natural beauty of the existing environment.

Potential:

The best sites for hydroelectric plants are swift-flowing rivers or streams, mountainous regions and areas with heavy rainfall. Only 20 percent of potential U.S. hydro-power has been developed, but unfavorable terrain and environmental concerns make many sites unsuitable for hydropower plants.

However, since only 2,400 of the nation's 80,000 dams are currently used for hydropower, new projects do not necessarily require building new dams—many existing dams can be retrofitted to produce electricity. At existing hydropower plants, advanced technologies can be installed to increase efficiently and energy production.

Are they available, now?

Yes...and a demonstration of the technology can easily be arranged at our Austin, Texas location. The cost of each individual unit is still quite high, however due to the fact that until investment monies and larger scale production take effect, we are still forced to design each unit on a "per order" basis.

Do Our Hydro-Power Systems work?

Yes - they work quite well! The simplicity of the system, and the lower cost make them quite an attractive alternative to conventional hydro-power systems. Hydropower is an old established method of energy production. Water is captured via a filter / intake structure, accelerated through a Schauberger vortex inducing structure, and passes through a pipeline to the turbine. The water exits the pipe under pressure through a nozzle and strikes a water wheel (our Tesla based bladeless disk runner). The water flow spins the runner, which is direct-coupled to an electricity generating permanent magnet alternator or enhanced performance induction generator. The electricity is then electronically regulated and transmitted via cable for commercial utility use.

How much energy can be produced?

This depends on the water pressure and volume available. Pressure is measured in terms of "head". Head is the vertical distance, in meters, from the water take-off point to the turbine. Even though our systems are radically different from conventional hydro-power systems because they do not require a dam or drop in elevation, the system still requires pressure and suitable water flow (water velocity and water volume). The volume is measured as "flow" in cubic liters per second. Once accurate head and flow figures are available, potential energy can be calculated. Accurate site evaluations and system design

are just some of the services available to you.

How much of the creek flow or river flow should be used?

Generally speaking less than 50% of the flow at the driest time of year. This will allow water for the fish, other creatures and the environment.

How do I get more information?

[E-mail Frank Germano](mailto:frank.germano@frank.germano.com)

Our Technology is based, in part, on the work of Viktor Schaubberger Living Water: Schaubberger and the Centripetal Force

[Victor Schaubberger](#), born in 1885, set a modern precedence in the understanding of the nature of water. His insights came from observing natural phenomena such as the undulation of the water snake and the meandering nature of water. Some saw applications of his insights, hiring him to construct means of timber transportation. His understanding of cycloid spiral motion allowed him to build chutes and flumes (up to 50 kilometers in length) to float the logs off the mountain. Others tried and failed to duplicate this work. The log flumes were considered technological mysteries. He was officially appointed the Austrian State Consultant for Timber Flotation.

With access to new trees and no restrictions, large timber companies sprang up everywhere. The dangers of technological misuse became apparent. By the end of the 1920's he was promoting sustainable methods that were in harmony with Nature's motion. He realized the creative centripetal force, versus the destructive centrifugal force. In his time he became known as the water magician. WW II arrived. Resisting the political pressures of the time in a semi-coerced atmosphere, Viktor refrained from disclosing vital aspects of his research. The Russians burned down his lab and house before the Americans got a chance to investigate. He spent his remaining years working with the ancient highland farmers of Austria, uncovering mysteries of magnetism, soil, and water in relation to crop growth, vitality, and strength.

Viktor Schaubberger's central theme was: ***"Prevailing technology uses the wrong forms of motion. Our machines and processes channel such agents as air, water and other liquids and gases into the type of motion which Nature only uses to decompose and dissolve matter. Nature uses another form of motion for rebuilding. When our technology only uses the decomposing motion, it becomes a dead technology, a***

destructive one, dangerously affecting all of Nature."

This is where the past meets the future. This is today. This is the satori where the rational illusion of a fixed three dimensional space and of an unwavering linear time become no more. This is the infinite mystery of which WATER is the greatest metaphor.

This is part of my PERSONAL website, at "Frank.Germano.com".

END

[HOME](#)

[INDEX](#)

[TESLA TECHNOLOGY, TODAY! :](#)
[THE DEFINITIVE BLADELESS DISK TURBINE WEBPAGE](#)



IMPLOSION TECHNOLOGY

AN ALTERNATIVE , SUSTAINABLE, NEW BASIS FOR MODERN TECHNOLOGY.

Introduction:

This webpage is an altered version of, and an addition to, the basic report on implosion, by **Callum Coats** (author of Living Energies and the Eco-technology series books) and is intended to advance on his initial undertaking. Many thanks are due to Mr. Coats, in respect to the enormous work that he has already done. He has been the true pioneer, and, has single handedly brought Viktor Schauburger's theories into a new light and true public awareness. I have taken great liberty by modifying the original proposal by Callum Coats (CalCoats@dnet.aunz.com), and hopefully, by thrusting "**Frank Germano & Martin Dorantes**" into the mix, we can force large corporations, governments, and "big business" to take a serious look at Schauburger's amazing implosion devices.

In June of 2001 the proposal to do a report on Viktor Schauburger and "Implosion technology" was begun by Callum Coats; A number of planned steps are being made for the development of Implosion technology. Doing this report is one of those first steps, coupled to practical research and development undertakings in the United States, Austria and Australia. This report contains sufficient information to start with research and development and with the re-building of some devices designed and made by Viktor Schauburger, which applied Implosion technology aided by diamagnetism and anti-gravity. Frank Germano and Martin Dorantes, founding members of International Turbine And Power, LLC, will lead in the investigation and implementation of this technology, and explore the potential of large-scale commercial utilization of the devices. Several units have been designed and the necessary funding for this project is currently being located.

Individuals and groups of people are actively pursuing this area of interest world wide. Study and experimentation has continued after Schauburger's death, especially during the last 20 years. A substantial amount of information exist in his own writing, in books, articles, reports and historical accounts, including what took place during and after the Second World War. The motivation for this report is my focus on getting this Implosion technology and some of Viktor Schauburger's other inventions established and applied in our society. The many life threatening environmental deadlocks of our present time, are a legacy of the type of technology we currently employ, using fossil and nuclear fuels.

Finding scientific, practical, and sustainable solutions has now become a matter of survival, for us and for many plant and animal species, in the short term. Another motivation is my

determination to help break the "stalemate" situation which has held this Implosion technology from being developed for over half a century, in spite of today's environmental crises. The development of scientific knowledge cannot be halted indefinitely, but for a relative short period of time. Making a report, assimilating all the available information, and networking, is the first step towards that goal.

The objective of this report: It is the objective of this report to, 1.) provide extensive information on Implosion technology and on the inventor, Viktor Schauberger, and his numerous designs and devices. 2.) To establish networking and associated activities. 3.) To stimulate further research and development worldwide, and 4.) To assist fundraising applications for practical research and development work.

Basis of understanding: To do justice to implosion itself, it must be described within its full context. That context is "living water". In my view, this can logically not be otherwise! In order to understand Implosion technology and to successfully apply it, an understanding of the principles and mechanisms involved is required. These are displayed by all aspects of "living water", with all of its features and characteristics, and by its inherent qualities and potentials. Holistic thinking is required to understand what Implosion technology is, what is involved and how it works. Thinking in **processes**, rather than in fixed concepts, wherein the totality in which any natural phenomenon occurs, is understood and accounted for. Our more familiar **linear** way of thinking nowadays, thinking in terms of cause and effect, does not suffice! The existence of implosion and the nature of diamagnetism are known, to an extent, yet largely ignored by modern physics. Since Schauberger's time, any physical proof has all but disappeared, so they remain to be investigated and formally clarified.

Today's technology: The basis and primary mode of today's technology, is based on **explosion** - expansive, centrifugal movement. We have directed our attention on the **degenerative** forces in nature by using combustion, heat, friction and pressure. It is known that the efficiency of this energy base (fossil fuels and nuclear energy) is not more than 35%, that it exploits the natural resources, and is responsible for extensive pollution and damage to the natural world. It stands to reason that we now look the other way to a frictionless cooling and compacting of matter through the geometric coiling action of the cycloidal spiral movement in a VORTEX.

Until recent times, we have been incapable of clearly seeing the simplest natural phenomena, while being continuously surrounded and bombarded by them. We fail to notice and are unable to decipher a myriad of examples which illustrate the activity of the spiralic, imploding principle. There are many vortex examples: e.g. shells, galaxies, antelope horns, sunflowers, pine cones, tree branches, tornados, cyclones, hurricanes. These are the after-images of pure, creative activity, working through a specific movement. These are obvious and clear physical imprints of the imploding activity. This activity is the mechanism by which the "World of Energy" connects with the physical world.

Callum Coats' argument is that we should use this formative principle as an energy base. In short - The spiralic contracting movement, as in a vortex, has not been utilized technologically. An energy source, which sustains us and surrounds us in abundance remains untapped. There are very good, and urgent reasons for investigating this as yet untapped vortex energy **thoroughly**.

The principles involved with Implosion technology: All movement is the outcome of attraction or repulsion; between *expansion and contraction*. All life forms develop as a mirror image, or, as consequence of this activity, between polarities. By imitating the examples which nature shows us - both the **creative and formative** natural processes can be enhanced to a maximum output situation (e.g. the smaller a hole of the vortex is, the stronger the suction will be). When this natural principle is artificially accelerated, this energy source is made available.

This technology utilizes the levitational properties of water and uses diamagnetism, as raw energy, present within a biological vacuum. This technology copies creative processes, therefore it yields positive and sustainable results in excess. (Some of Schauberger's' inventions were "Free- excess energy" devices.) In Implosion technology, two types of motion are combined or simultaneously taking place - Centrifugence: which gives pressure, friction, temperature rise and biological deterioration. - Centripetence: giving suction, temperature drop and biological improvement.

The working mechanism: the double cycloid spiral curve (as in a vortex) concentrates , contracts and compacts the water. This contraction cools and this cooling creates a vacuum. This vacuum augments suction, the whole process generates a diamagnetic force. Compacting physical matter to point beyond which it "dissolves" into its energetic form and thus allowing it to return into the physical, can be achieved artificially or mechanically.

It is important to remember:

- 1.) the combination of the centrifugal - and centripetal movement
- 2.) the equatorial alignment of particles (diamagnetism)
- 3.) the negative electric ionic charge and the negative pressure (a gradual or sudden concentration of liquids or gasses produces a negative pressure and through this, implosion.)

"Comprehend and Copy Nature"

The principles which Viktor Schauberger adhered to and implemented in order to make the "Implosion motor" and other (levity) devices, were derived from having this attitude: **"Comprehend and Copy Nature"** or "C2".

Benefits and perspectives of Implosion technology: Should we be able to illustrate and prove the claims made here concerning Implosion technology, the consequences for modern society as we know it would be significant indeed. The re-development of this Implosion

technology would have more than a major impact on the way we live and on the way we do things. It will not have to take long for people in general and for our environment more importantly, to experience the unimaginable benefits from using Implosion technology.

Electrical power can be generated at home from spring water. Levitation devices will go six times faster than the Boeing 747 at a fraction of the running costs, without pollution or any noise; their possible size being unlimited. Good drinking water ("Wunder Wasser") can eliminate sickness and disease in the living organism. Implosion technology does potentially offer sustainable solutions to many of the environmental crises of today. The use of implosion technology allows us to eliminate the general need to use our current types of inefficient, exploitative and damaging technology which still use combustion. Implosion technology stands to revolutionize our entire social fabric.

There are some technical, organizational, and financial hurdles to be overcome to achieve our set goals for the development of Implosion technology, however, given the proper funding, rapid achievements can be expected. My estimation is that in two years (from now) we can start breaking into the market with devices, such as were made in Schauberger's time, which use Implosion technology. In the "Emerald Tablets" the "Tabula Smaragdina", the following can be found : ***"Combine the heavenly with the earthly in accordance with the laws of nature, and health and happiness shall be yours as long as you live"***

Research, education, and outcomes: Several groups of people are doing preliminary experimentation on liquid flow phenomena, and with Schauberger's concepts. As far as what is known to Coats now, the following initiatives are undertaken:

- in Austria: summer seminars are given at the "Pythagoras Kepler Schule" (or P.K.S.), the Schauberger family estate near Bad Ischl,
- in Germany: lectures are given and articles are published (e.g. by Ron Engert), describing the above,
- in The Netherlands: attempts are made to organize the planning, the funding, and the co-ordination for research & development and production. Together with the Australian team, some excellent results are expected.
- in Sweden: research is being done on various flow phenomena of water; free flowing and in vessels,
- in Germany: researchers are looking in libraries and archives for articles, news reports, eye witness accounts, and quotes on early facts of the "lost" data and Schauberger's earlier achievements (e.g. flying saucers),
- in the USA, an investigation, mainly by digging up any (hidden) information on the world-wide-web has started, mostly with the resurgence of interest in Schauberger technology from the Callum Coats books, and by individual websites. Additional views are being presented and all patent data is continuously being absorbed and published.
- in Australia: research and development has started on three proto type devices, which will demonstrate some of the principles of Implosion technology and which will then become

available as products.

- Contact is being maintained with the Schauberger family in Austria and with Mr. D. Feierabend in the US (who is in possession of one of the original devices), by Callum Coats.

- Frank Germano, has begun CAD work and renderings of the Schauberger implosion devices. Preliminary figures and computer mock-ups suggest that the devices will work as described. Investors and funding is being sought to further the research and development stages. Germano feels that a true working prototype implosion device is operational within six months of initial funding. Further research and development has been undertaken by Frank Germano and Martin Dorantes, individually. Professor J. Naudin (of [JLN Labs](#)) from France has duplicated this original pioneering work, as has Robert (James) Bailey, Dr. Eugene Sorokodum, PhD ([Vortex Oscillation Technologies](#), LTD from Moscow, Russia), and Prof. Alfred Evert, PhD (of [Evert Fluid-Tech, Inc.](#)) as well.

Networking: A sound network of people is building up world wide, with people and groups interested in the re-development of Implosion technology. The various activities should be coordinated in a cooperative and constructive manner, to achieve any desired results more quickly. Reports and articles are appearing steadily on the internet, which are monitored and filed by Callum Coats. The exchange of information and ideas is mutually beneficial, and therefore, I have taken up forming a central network. Once the network is fully operational, all parties involved will share and be connected to information, instantaneously.

Research and development of Schauberger's inventions in the United States and Australia: The Australian team is developing three Schauberger inventions. ITP is combining efforts to fund development on all of the Schauberger implosion devices, and the water purification systems, and the pumping systems. These form the first practical steps towards developing the necessary theoretical and practical knowledge to start with the Implosion motor. These first devices, are:

1.) **The "Energy body" for rivers:** egg shaped bodies creating longitudinal vortices in the central water flow. The longitudinal vortex creates a cooler, condenser, faster flowing central water mass which is the mechanism by which the river carves out it's own desired flow path, and which trout and salmon use to migrate up the rivers for spawning. Many problems we experience with rivers and streams, e.g. flooding after some rain, are a result of human interference with the forests and the actual flow-path of rivers. Canalization and dredging are about the worst things to do to a natural river. These problems can best be solved by helping such a river re-establish it's natural, dynamic flow pattern. These "energy bodies" are described by Schauberger to yield dramatic, positive, changes in the riverbed formation within a very short time span.

2.) **A vertical pump:** imitating capillary action of water and air bubbles much like across

between a tree and a ram pump. Lifting a water column higher than nine meters vertically has been impossible up to now (laws of physics-gravitation). There are places such as farms, where a significant change would be experienced if there would be a brake through, making water available where previously that wasn't possible, e.g. by pumping water straight up from a bank or cliff, out of a river. This development may be a brake through in terms of what is known about pumps and pumping water in different ways, however more importantly it demonstrates the "C2" principle in practical application. By utilizing TTI's vast knowledge of the Tesla-type pumping systems, and comparing them to the Schauberger systems, a proper evaluation of their worth can be attained. It may also be advantageous to combine the two systems in some form or another.

3.) **A water purifying device:** a purifier which is using the so-called "Wavy plates" to achieve centripetal movement. Some CO₂ is added in the process, separating and cool-distilling the water imbues it with levitation properties and makes it ready for human consumption (best at 4-5 degrees Celsius). The remainder of the water keeps being processed in this egg shaped device, which has a manometer to measure the vacuum created. These are the first serious steps towards development of the implosion motor, as, the "wavy plates" are used. These were designed by Schauberger after using a wheel of "Kudu horn" shaped tubes (these original devices are extremely difficult to construct). This "mark 2" design principle, once proven successful, is where the Australian team will pick up the development of the implosion motor. These relatively simple devices can come into production, offering direct, practical, sustainable solutions to existing problems.

4.) **Dorantes & Germano** will complete investigation into feasibility of Repulsine, Tornado Generator, Implosion Motor, and Trout Motor type engines and machines. As funding becomes available, they will build working prototypes of these machines and evaluate their effectiveness, performance and cost of operation and commercial viability. Germano is presently designing the first-ever, Schauberger-based vortex energy water-powered spiral generators. Through the use of ANY naturally flowing river (with a water flow greater than 30 cubic meters per second), we can harness the energy of the flowing river water, channel it into a "Spiral Vortex Generator" (using our newly developed "**InVAID**®" system - Initiated Vortex Accelerated Implosion Drive - patent pending), and direct the accelerated water flow into a modified Tesla-type water turbine. The results are very impressive. It is also a solution and a means of supplying almost unlimited, non-polluting electrical energy to any community, town or city. No ecological damage, in any way, results from the implementation of this type of river-flow based power system. Please see my report on "[Water Power](#)", and "[Water Power II](#)" for a complete explanation of the devices.

DESCRIPTIONS OF WATER

Water itself...What is water? We may truly ask!. Water is everywhere, and predominantly so. There are many answers to that question as there are as many types of water as there are

living organisms.. Maintaining the opinion that water is H₂O is merely reducing the matter to "the lowest common denominator" only. Of all the water on Earth, only 2-3% is available as drinking water. This should be kept in mind while we use and abuse that small amount! When we see water not merely as H₂O, but as versatile and highly mysterious substance, we might get closer to understanding the dynamics, the harmonics and potentials this medium displays to us.

Water was here first, so to speak. It is a mystery and a complete wonder in itself that it was created at all !!! If we would understand water, we would not have the many perilous environmental crises of today.

Some characteristics of water are:

1.) The dynamics of flowing, GOOD healthy water is bristling with levitational and healing qualities.

2.) Water is always in change. It flows down and moves about at varying speeds, shaping and folding itself in layers which slide over each other, thus fitting a greater volume into a smaller surface area and cooling it off. The forward movement of every particle is closely associated with a specific temperature. Schauberger made a big point about "the temperature gradients", which regulate movement.

3.) When flowing water warms up (e.g. by the sun), its tractive forces weaken. Cooling down occurs in the flow-axis. This core water mass moves fastest and thus deepens its' channel.. This higher flow-velocity, relative to the peripheral flow along the embankments, creates suction, which also releases pressure from these embankments. The higher the flow-velocity of the cooler core-water mass is, the higher the buoyancy.

Water Quality: Water is qualitatively not the same at different temperatures; Water can "go off" too. The anomaly point for water is at +4 degrees Celsius, where water is healthiest and densest. Water always carries other substances. The sea water contains mineral salts and silicon from eroding granite mountains. This silicon is associated with the waters' levitation properties, which is why Schauberger uses siliceous emulsions in his Implosion technology. (In Bio-Dynamics too, great importance is put on the role of silica, whereas in conventional agriculture it hardly gets a mention.) Water is electrically charged too, during and after a storm the drop size is enormous at times. As such, water can justly be called "The Blood of the Earth". It is rich in many ways and very much alive.

The Wave: What is a wave made of? The wave but momentarily shapes and uses the water after which it fades away to be replaced by another waves. The continuum, and re-entering of other waves without canceling each other out is an expression of energy. The seas' water mass, as a whole, rocks gently sideways, determined by the Earth's rotation, as well as the Lunar and Solar gravitational pull. In the sea, the wave goes through the water; the water itself doesn't travel far. In a river the water goes through the wave, here the wave is stationary. The ocean wave gets its energy mainly from the wind. In the river, the wave is formed by the rocks and sticks and banks. Is a wave really part of the objective world? A wave is made of energy; pure energy in motion.

The Meander: Water naturally flows down any gradient, however it does so seeking the long way down. It doesn't move downwards as a solid "body" of water in a straight line seeking the fastest way. On the contrary, it "wanders about" from left to right and forms an irregular snake-like, general flow pattern called a "meander". This meander is seemingly chaotic, and appears to be shaped at random without much order. The curvatures, however, correspond by and large with the curvatures that can be found in very many natural phenomena, (e.g. in tree branches, in lightning and in many proportions of our own body).

Flow Dynamics: There are a myriad of flow dynamics in such a stream of water, which would explain the creation of this long meandering pathway, which the water always seeks on its way down to the sea. E.g.: cooler water moves faster than water which is slightly warmer (i.e. 1/10th degree Celsius), thus creating drag and possibly suction. It is also more compacted or dense. Whereas the body of water as a whole might stream downwards at a certain flow rate, there are numerous places and occasions where water actually flows in the opposite way, or slower, or is momentarily at an apparent standstill. The essential point about the meander is the apparent chaotic- but specifically ordered- movement, from left to right and back. It is like a cross section of a spiral, with the mathematical base pattern: $1=1:1.618$.

The Vortex: We have all experienced vortexes in our lives. The best examples are found in rivers and streams. For most people who don't often get to experience and observe rivers or streams, there is the experience of a draining bathtub or sink. Gravity is a major aspect with the latter example, however these are still good examples of what actually takes place in such a vortex and serve to illustrate the processes which are involved.

A defined body of water (or air), with a certain mass and surface area, has a flow rate: the velocity of which increases in an accelerating fashion, while the surface area is twisted into the vertical plane around a hole and decreases. The physical mass gets compacted to a point beyond which it "dissolves" into its' "energetic form" or matrix, leaving the "space" and "energy" (from between the sub-atomic particles), which we call "vacuum" or "void", while resulting in negative pressure or suction. A biological vacuum is created, which again augments the suction. This whole process produces *diamagnetism*.

Sub-atomic energies such as the "Weak Nuclear Force" and diamagnetism are released, and, like the suction or levity, are potentially available. Aspects involved with this process are the specific characteristics of the medium. With water or air:

- 1) compaction when temperatures reach the "anomaly point".
- 2) the "dynamics of flow" (such as the "folding" in layers) and a flow rate-differential of water or air particles related to.
- 3) the "temperature gradient": successions of temperatures up or down (i.e. positive gradient or negative gradient), always aiming for the anomaly point. The anomaly point is where a substance or organism is "healthiest" or "best"; for water this anomaly point is at 4 degrees

Celsius, for us humans it is 36.5- 37 degrees Celsius

4) the actual pattern of movement; the shape, the proportions, and the curvature of it's pathway, is very specific. The harmonic of the double cycloid spiral curve is based on "PHI".

PHI: PHI is the specific formative principle expressed mathematically in the ratio: $1=1:1.618$, the so called "Fibonacci cycle", better known as: "The Golden Mean". (each number added to the next gives the following number, as in 3-5-8-13-21-34 etc. or multiplied by 1.618 = 0618-1.000-1.618-2.618-etc.). Daniel Winter (U.S.) calls this harmonic : *"The only permissive path from matter to energy and back. The Mathematical image of the condition of pure self reference"*.

The possibility for the development of Implosion technology exists, however, any physical proof of the success of Implosion technology by Viktor Schauberger has disappeared. Implosion technology can be easily developed because of the inherent simplicity of the devices. The current environmental crises leaves us no choice but to develop this type of technology. There are some basic uncertainties surrounding Implosion technology, e.g. unknown side effects (chain reactions?). There is a need for organization, coordination and cooperation to unite the various practical efforts world wide.

What is Implosion?: Today's technology is solely based on explosion. This is the process that has been adopted to use the energy stored in our planet's natural resources to heat our homes, drive our cars and to produce our electricity. The explosion process, however useful it may seem, is extremely wasteful and inefficient. Most of the chemical energy stored in fuel is lost in the conversion process into mechanical or electrical energy. To travel a distance of 1000 km (~600 miles) in an average car requires an energy expenditure of 1000 kW. This equals the energy requirement of one human being to live and do all his physical and intellectual activities for one year (Coats, 1996). Most of the energy is lost during an explosive process through frictional resistance, which produces useless waste heat. The waste heat from all industrial processes, which are almost exclusively somewhere along the line based on the explosive use of fossil or nuclear fuels, causes our planet to warm up. In nature (unlike conventional technologies) minute temperature differences will cause very large changes. If our own body temperatures go up by half a degree above normal we feel unwell. Our planet reacts to equally small changes in temperature.

Further to being heat generating, wasteful and inefficient, the combustion (explosion) of fuels produces by-products which harm us and pollute our planet. Furthermore, atmospheric oxygen, the element needed by all of us to breathe and exist, is wastefully consumed during the explosion process. An average car, driven at 50 kph (~30 mph) consumes about 750 times the amount of oxygen needed by a human being (Coats, 1996). At the same time, our oxygen producing global forests are being cut down at an alarming rate.

Implosion is a suctional process that causes matter to move inwards, not outwards as in the case of explosion. This inward (centripetal) motion, however, does not follow a straight (radial)

path to the centre, it follows a spiraling whirling path. This is called a vortex and is the secret of nature.

Have you ever wondered why bath water, when emptied, flows through the plug hole in this spiraling vortex fashion? Water will always try to follow the path of least resistance. This is what the vortex is enabling it to do. It is reducing resistance by curving more and more inwards thereby avoiding the confrontational resistance of straight motion. This is the fundamental reason for the plug hole vortex phenomenon. The Coriolus Effect due to the Earth's rotation determines the direction of spin of the vortex.

A characteristic feature of a vortex is that the outside of the vortex moves slowly and the centre moves fast. As water is imploded in a vortex, suspended particles which are denser than water are sucked into the centre of flow, frictional resistance is reduced and the speed of the flow increased. This was verified through experiments conducted by Professor Dr. Franz Pöpel at the Stuttgart Technical University in Germany in 1952 (Alexandersson, 1996; Coats 1996).

The vortex motion, which also causes a drop in temperature and increase in density, is paramount for water to stay healthy and disease free. Natural water courses are naturally spiraling and meandering and the water in them forms whirls and eddies, which are vortices. The vortex motion can also be observed in whirl winds. The suctional force generated within tornadoes is typically strong enough to lift houses and uproot trees.

In stark contrast to nature, the conventional technical motion along straight paths causes resistance to build up exponentially with speed. A small increase in speed causes a large increase in resistance. Pressure and temperature are increased. This means that the higher the speed the greater the losses to friction.

In nature there are virtually no straight forms, and whenever possible, vortices, spirals and curves are produced to reduce resistance. Yet in conventional technology, explosion/combustion and straight motion are employed, both of which increase resistance and temperature and are fundamentally against nature and every living thing. The realization of this caused the Austrian Viktor Schaubergger, the father of implosion technology, to proclaim emphatically in the early part of this century: 'Our technologists are moving matter incorrectly. Their technologies and interference with nature is detrimental to us and our planet'. His maxim in life was 'Understand and Copy Nature' (Callum Coats, 1996).

There is another not so apparent reason, why in the natural world around us there are so many spirals, as can be seen in shell-fish, snails, antelope horns, on a small scale in our spiraling DNA molecule and on a large scale in spiraling cosmic nebulae. I am now about to enter the realms of etheric energies, which are widely known and understood in many cultures. To our Western world, however, these concepts may still seem strange.

Etheric energy: The Greek derived word ether is defined in the Webster Universal Dictionary as a 'hypothetical medium, supposed to fill space, by means of vibrations in which light and

other forms of radiation are transmitted'. Up until the latter part of the last century the ether theory was an established scientific fact. The Michelson-Morley experiment, carried out in 1881, concluded that there was no Earth motion relative to the ether (Encyclopedia Britannica, Vol 8, p.98). This experiment discredited the ether theory and caused its rejection in favor of the theory that space is a vacuum and air is merely a chemical composition of Oxygen and Nitrogen plus other minor constituents.

It is argued here, that the ether theory was rejected too hastily, that it is basically correct and only requires some modifications. The established ether theory of most of the last century was that ether is a static medium. However, ether is dynamic vibratory energy. It is very much in motion. And this motion always follows a vortex path. All manner of different vortex sizes and shapes exist, but basically, etheric energy moves in a vortex. The American John Worrel Keely, the father of sympathetic vibratory physics, stated this in the late 19th century. He invented machinery, which was driven by this subtle etheric energy (Pond, 1996). His theories and inventions were opposed by organizations with vested interests, to which he eventually succumbed. His understanding was beyond that of his contemporaries. He was far ahead of his time.

Despite the problems he encountered, he and others like Nikola Tesla, Viktor Schauburger and Wilhelm Reich have shown that etheric energy, although invisible to most, is very real. It is the substance that is enabling the perpetual motion of planets, stars and universes. It is the driving force. Planets are moved within the flow of ether, similar to logs being moved by the flowing water of a river. This explains why there is no relative motion between Earth and ether (Senf, 1997).

Ether is a broad spectrum of vibrations which is composed of negatively charged planetary energy and positively charged cosmic energy. The planetary (Earth) energy has maternal nurturing qualities; the cosmic energy has paternal qualities. In Eastern knowledge these two energy counterparts are known as yin and yang. When these two types of energy are united in the right proportions they create an energy field, in which the ether is concentrated to such an extent that matter forms. Once matter has formed it emanates its own specific biomagnetic field (aura) which fuses with the original energy field.

All matter, on a sub atomic scale, is energy. The nucleus of an atom, its material core, is infinitesimally small in comparison with the size of the atom. If the entire space within an atom were to be filled with particles the size of its nucleus, one million billion (10^{15}) of such particles would be required to do so (Asimov, 1977). **Everything is space, and space is everything.** This space is ether - vibratory energy! Keely wrote in 1893, "there is no dividing of matter and force into two distinct terms, as they both are one. Force is liberated matter. Matter is force in bondage" (Dale Pond, 1996, p.90)

Etheric energy moves in a vortex fashion, because the vortex provides least resistance to the flowing motion. It follows that physical matter, which is materialized etheric energy, seeks the same low-resistance motion. As mentioned earlier, the natural mediums water and air have this intrinsic vortex motion. Our blood and the sap of plants, move in this way too. After all, our

veins, arteries and minute blood vessels are not straight channels. They are winding their way through our bodies just like a river is winding its way through the countryside. A short newspaper item in the Daily Mail from 8 May 1998 stated: "Medical scientists working with aeronautical engineers at Imperial College, London, found that blood 'swirls' as it rushes through an artery. Furthermore, nature has designed arteries with a helical 'twist' to encourage the swirl..."

Water needs the natural winding spiraling vortex motion to stay healthy. This is because this motion allows it to recharge and sustain its life force, which is apparent as the biomagnetic energy field surrounding it. Thus, water is etheric energy in bondage, but it has to move in this particular way, lest it loses its life force and becomes stagnant and lifeless.

VIKTOR SCHAUBERGER: DISCOVERY AND HISTORY OF IMPLOSION TECHNOLOGY

Introducing Viktor Schauberger:

" They called me deranged. I hope that they are right. It is of no greater import if another fool wanders this earth But if I am right and the science is wrong, then may the Lord God have mercy on mankind." Viktor Schauberger. Viktor Schauberger was born as a foresters' son in 1885 in Eastern Austria and lived until mid September 1958. He had no academic training but had a deep knowledge of biology, chemistry and physics. He also was a good drawer and craftsman and developed an exceptional understanding of water and its natural (flow) phenomena.

He had an uncompromising believe in his perceptions and concepts, was obstinate when opposed and had a choleric temper, which was frequently expressed in his writing. Viktor's deepest wish from early childhood, was to be a forester like his forefathers had been right back to the 15th century. He didn't finish school and spent his time in the forest before he became known through the building of water flumes for the transportation of big mature timber logs from the forests in the mountains.

He built and designed many other devices and tools after that, all based on fundamental, creative principles which he had observed to be at work in living nature. He was able to see the natural world holistically, unlike us who tend to concentrate on "the thing itself". He saw any natural phenomena: be it a river, a fish, a tree, or a bird in the context of the environment in which it occurs. He therefore discovered how specific archetypal principles and shapes are expressed consistently in any living organism, in design as well as in function. He brought this insight down to earth with his above mentioned skills and through quite advanced inventions.

Biography:

6-30-1885... Viktor Schaubberger is born in Holzschlag Eastern Austria...

1914-1918 has a job as a forester and is a soldier during the First World War.

1919 First he is a forester, then he becomes a forest master and game keeper in Brunnenthal/Steyrling, under jurisdiction of Kirchdorf, (on the Krems river, Eastern Austria) and of Count Adolf zu Schaumburg.

1922 Schaubberger designs and builds the water flumes at Steyrling and reduces logging costs to one/tenth. He is promoted to property forest- and game manager.

1924 He becomes State Consultant for logging flume installations.

1926 The "Riverbed fin" is developed and tested in Neuberg on the river Murz in Steiermark.

1928 Further Riverbed Finns in Austria- Yugoslavia and Bulgaria.

1929 First patent registration in the area of water technology and of turbine technology.

1930 Film "Carrying Water" about the Neuberg installation.

1931 First trials in generating electricity from water ("Wasserfaden Trial").

1932 Achieved the "Wunder Wasser" and water powered engines, implosion motor.

1933 First and only book "Our senseless toil" appears in Vienna.

1934 Meeting with Adolf Hitler on forestry and river management, refuses to work for the "3rd Reich".

1935 Air turbine patents are registered and the "lifting" of liquids and gasses into energy is achieved.

1937 The "Warm-Cold Engine" build by Siemens melts down after unauthorized testing.

1938 Viktor gives his son Walter authority to repeat the "Wasserfaden" Experiment; Walter achieves currents of up to 20.000 Volt.

1940 The "Repulsine" to obtain the "Wunderwasser", is constructed in Vienna.

1941 Difficulties and intrigues with the Vienna Engineering Association culminate, also increasing SS domination. Schaubberger works near Augsburg for Messerschmidt on engine cooling systems. There was some correspondence with Heinkel about aero plane turbine drive engines.

1942 The levitation device is started and crashes against the ceiling of the factory.

1943 Commencement of further design, research and development on the Repulsine at a camp near Mauthausen. The aim was developing a submarine drive engine.

1944 Further development on the "Repulsator" in Vienna, at the SS engineering college at Rosenhugel.

1945 Start on the "Climator". USA troops seize various devices and materials. Transfer to Leonstein.

1947 Further water purification devices are build in Salzburg.

1948 Co-operation with the Rosenberger Company in Austria, agricultural tools and the "Twister Pipe" are invented.

1950 Patent registration for agricultural tools made with copper.

1952 The "Double Twister Pipe" is tested at the Technical College in Stuttgart. Schaubberger's theories on altered friction in fluids are confirmed. The first copper plated plough is tested at Linz Agricultural College.

1954 The main part of the home power generator is developed, difficulties with first tests.

1955 Book by Leopold Brandstatter "Implosion or Explosion" comes out. 1957 Co-operation

with the Firm "Swarovski" in Tirol; further home power generators are build.

1958 An American consortium offers Schauberger financial means to research implosion technology. Journey to the USA with son Walter. After hardship and difficulties Viktor leaves the USA. After he had been forced to sign a contract which prohibited him from doing any further research and making any statements. Various devices and technical drawings are also to stay in USA. Viktor dies on the 25th of September in Linz, five days after his return from the USA.

Viktor Schauberger was a remarkable man, endowed with the ability to develop a technology based on natural, creative principles. He invented and built various devices for cleaning water and for electric power generation, as well as levitation devices. He designed dam walls, outlets for electric power plants, agricultural tools, special "twister" pipes, nozzles, distillation plants, "flow regulators" of various sorts for rivers, turbine engines and more. He did not however, have the gift of tact or patience when dealing with the establishment. He was continually annoyed and frustrated by academics, hydrologists, and engineers, and frequently lost his temper. Consequently his articles were banned from publication for some time.

Various designs and devices of Schauberger's inventions: water healing... flow regulation for agricultural use... Implosion technology... Spring Water Producer... River Log Flume... Wooden Twister Pipes... Home Power Generator... Repulsator... Emphore (water container)... hydro dams... fermentation chamber... Climator... Repulsine "a and b"... Longitudinal Vortex Generator... Manure Transformer... sterilization unit... Tornado Home Power Generator... Egg-energy Body... Spiral Plough... special "whorle-pipe" Nozzles... Implosion Motor... Trout Motor (submarines)... Flying Saucer.

Brief description of the Schauberger inventions:

- 1. Water healing:** The principle: Enhancement of the levitational properties of water.
The Spring water producer: Large water restorer created so called "*Wunder Wasser*".
The *Emphore* water container: Egg shaped water vessel to maintain stored water quality.
- 2. Flow regulation:** The principle: utilizing temperature differences and gradients.
The River Flume: Meandering wooden log transport canal build down mountain slopes.
Hydro dams: Designs for dam walls to reduce pressure and leaks.
Energy Bodies: Egg shaped river flow regulators, regeneration of longitudinal vortices.
Longitudinal Vortex generators: Concave- wedge shaped forms, for torrent confinement in rivers.
- 3. Agricultural:** The principle: utilizing flow dynamics, (also as radiation into the soil).
Wooden Twister pipe, or "*Whorl pipes*": Arrangement of little fins inside pipes, for spiral water flow for consumption water for people, animals and plants.
Fermentation chamber: Egg shaped vessel, placed under ground to enhance energy flow to

restore mineral imbalances in the soil.

Manure transformer: Egg shaped underground vessel for (aerobic) maturation of manure.

Spiral plough: Copper plated plough, for minimal soil damage and mineral restoration.

4. General use: The principle: utilizing electric charge and using flow dynamics in design.

Home power plant: Electric power plant for domestic use.

Climator: To acclimatize a room or house both cold and warm simultaneously.

Sterilization unit: One of many small designs, they illustrate the principles that Schauberger worked with.

Nozzles: Special fish shaped gold- or silver plated miniature nozzles for implosion motor.

5. Implosion: The principle: accessing the biological vacuum, utilizing diamagnetic force.

Repulsator: The second model water restorer, for break down of our body's excess acidity.

Repulsine: Vaporizes, purifies and distils the water through cold processes.

Tornado generator: Implosion motor, for electric power generation, using spiraled pipes.

Trout motor: "Biological submarine", also implosion motor design with wavy plates.

Flying saucer: Levitation device using rotating wavy plates and turbine technology. Also identified as the "Repulsine" in many reports and documents.

Historical developments 1940-1952:

The development of the Implosion technology takes place in a broader context than Viktor Schauberger only. Of particular interest is the fact that during the Second World War scientists like: Thule, Schriever, Habermohl, Bolenso, Miethe, Schauberger and others, were made to work together or in teams at several locations such as: engineering (war) factories throughout Nazi Germany like "Penemunde", "Mauthausen" (military camp Poland), and in laboratories, in Vienna-Austria and in Bavaria. Big firms such as BMW, Messerschmidt and Siemens, also took part in this technological development. There was a time squeeze...the war had already lasted three years; then there were some real achievements. During that last year of the war, the first test flights with different sized discs were taking place at the well known "Hanebu 2", above Prague..

In 1945 there were the reasonably well known "Foo Fighters", mounted with a "Klystron" microwave tube. These were small, semi ball shaped, pilot less, remote controlled flying objects. At the same time the World's first guided medium range missiles, the "V1" and the "V2", plus the "advanced" (model) fighter planes like the "Horten Ho 229", looking like the recent "Stealth" bomber were produced and used in Hitler's warfare machine. The doors had been opened to employing various forms of magnetism and electrical charge, as well as levity, (rather than having to overcome gravity!). Clearly the Nazi's were technologically ahead from the rest of the world as many new results were achieved. The Americans were keen to get on to this technology even during the war and to beat the Russians and the British to it!

At the end of the war the "Brains of Europe" were divided between the Russians and the USA. They "combed" Germany, and many Nazi's went to the States. This technology based on implosion consequently disappeared and was not seen again following the Second World War and Viktor Schauberger's death. There has therefore been a time gap of some 50 years, in the development of this Implosion technology.

A "science monopoly situation" was created and *upheld* by American political and industrial motives. ***The hard fact that the USA possess, and knowingly withholds this technology from being further developed as a sustainable alternative, was, until recent times, one of the most guarded secrets of the USA Government and it's Secret Services!*** Many reports were repressed. Inventors and scientists were ridiculed, and moreover, the first attempt to develop any aspect of this technology was directly halted (people were threatened and killed).

There have been numerous UFO sightings, especially during the 50's and 60's. The belief, or rather - cover-up - that these sighted objects had something to do with "Aliens" was successfully launched. This tabloid spoof diverted the attention. There were occurrences like the Spizbergen UFO crash 1952, which did get some publicity and which made it more difficult to conceal this hard fact. Today, with free flowing knowledge and information, particularly on the World Wide Web of Internet, this information can no longer be contained. Individuals and groups of people world wide are now inspired to pursue this matter further and to do practical experimentation. Basically...say "hello" and "hip-hip-hoorah" to the internet and the worldwide web!!! Just try to stop us now. ***People will no longer be intimidated.***

Summary:

The development of this technology stopped when the second World War came to an end. The Americans took all the technical data from places like "Penemunde" (Germany) as well as combing the existing libraries and patent registrations. This data has been kept secret until recent "internet years". Whatever information is still obtainable, is now being shared and studied world wide by a growing number of people. Some ecologists and farmers possess a degree of understanding of the phenomena and principles in nature which express the implosion principle. The available information plus the limited understanding of some people, is sufficient to study what Viktor Schauberger has achieved and to re-commence this work. The practical construction and application of these devices is necessary to study and confirm the principles and processes involved in Implosion technology.

Thank you for you time,

Sincerely,

Frank Germano

REFERENCE LIST:

This report is an altered version of the original, written by author **Callum Coats** (Living Energies, Eco-Technology Series, etc.) in 1997 and could not have been done without his considerable research. "Living Water" In partnership with nature, by Olof Alexanderson...Dr. J. Bockemühl New Physics (1991-92) ... Klystron (microwave source) ... The Spitzbergen Ufo Crash, 1952 ... The Borderlands Archives ... "Living Energies" - Water Wizzart ... Metamorphosis of the Plant Energy Potentials in Water Chronology 1933-1949... Tornado Energy Project... Magnet Light, Matter and Gravity... Dynamic Hydro Power - Viktor Schauburger - Water Purification and Free Energy (coll. of documents)... Music of the Spheres ...Operation Paperclip (Nazi's to USA), Secrets of Schauburger's Saucers;Implosion magazine... Path to Natural Energy; Implosion Magazine's "Rhythm of the Stars"... Sensitive Chaos, Cosmic Evolution: Thomas Bearden, George Caryotakis, Ole Jonny Braenne, J.W. von Goethe Ehlers, Sauerlach and Pfeiffer Freezone-Ewertverlag, Prof. Alfred Evert, David Hamal (design your UFO), Josef Hasselberger, Curt Hallberg, Hoffman and W.J. Eaton, Guay Murphy: Press Release Oct. 1995, Jorge Resine Riley, Crabb and Thompson (1985), Viktor and Walter Schauburger, Joachim Schültz, Theodor Schwenk, Rudolf Steiner: Omega File (Nazi history), Swimgate, The Physics of PHI: Daniel Winter, and Implosion Magazine.

[\[the Telsa & Schauburger Bookstore\]](#)

VIKTOR SCHAUBERGER:

[\[Water Power - Vortex Theories-\]](#)[\[Water Power II\]](#)

[\[Viktor Schauburger -1-\]](#)[\[Viktor Schauburger -2-\]](#)[\[Viktor Schauburger -3-\]](#)[\[Viktor Schauburger -4-\]](#)

[\[Christian Links\]](#)





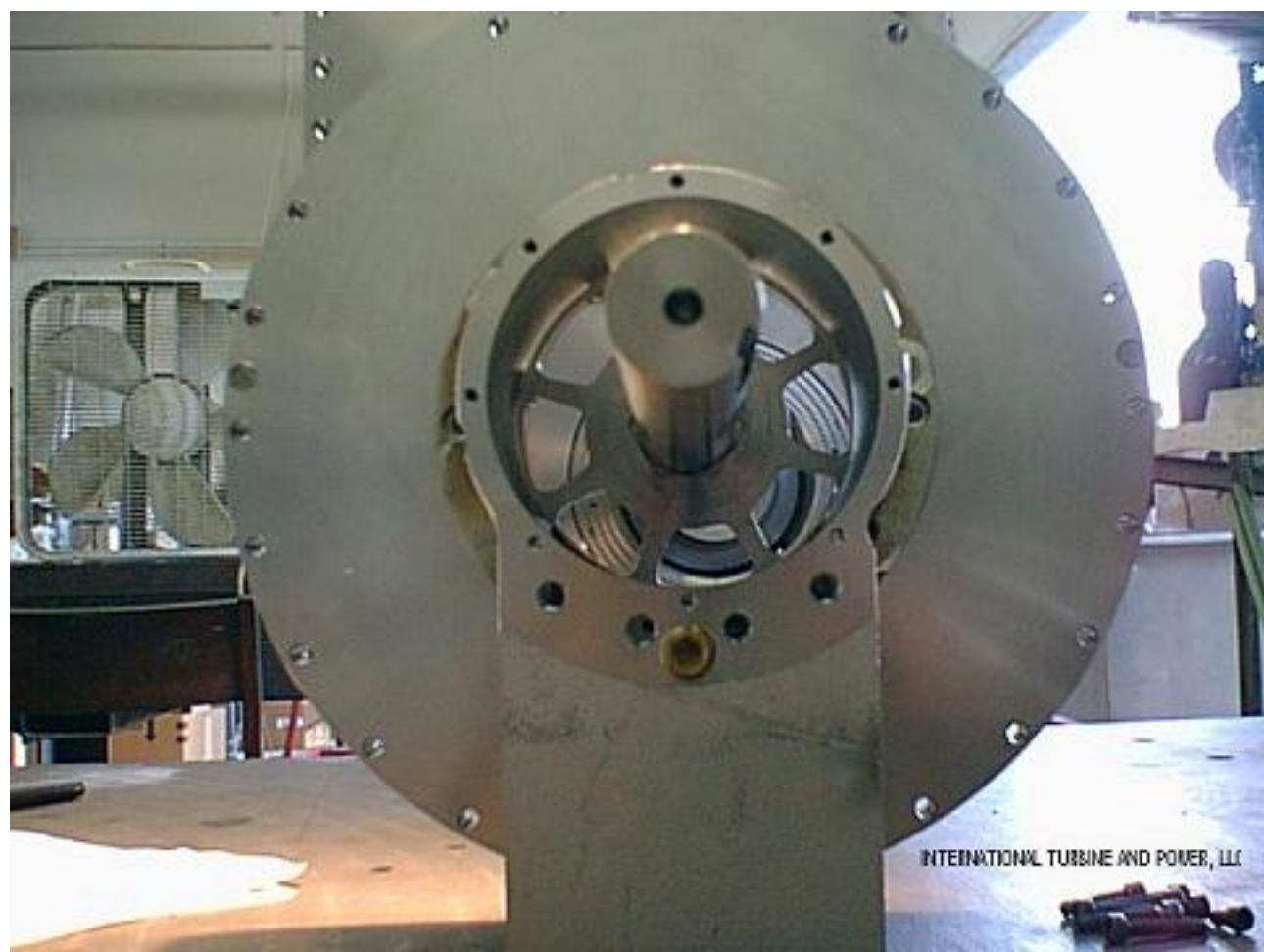



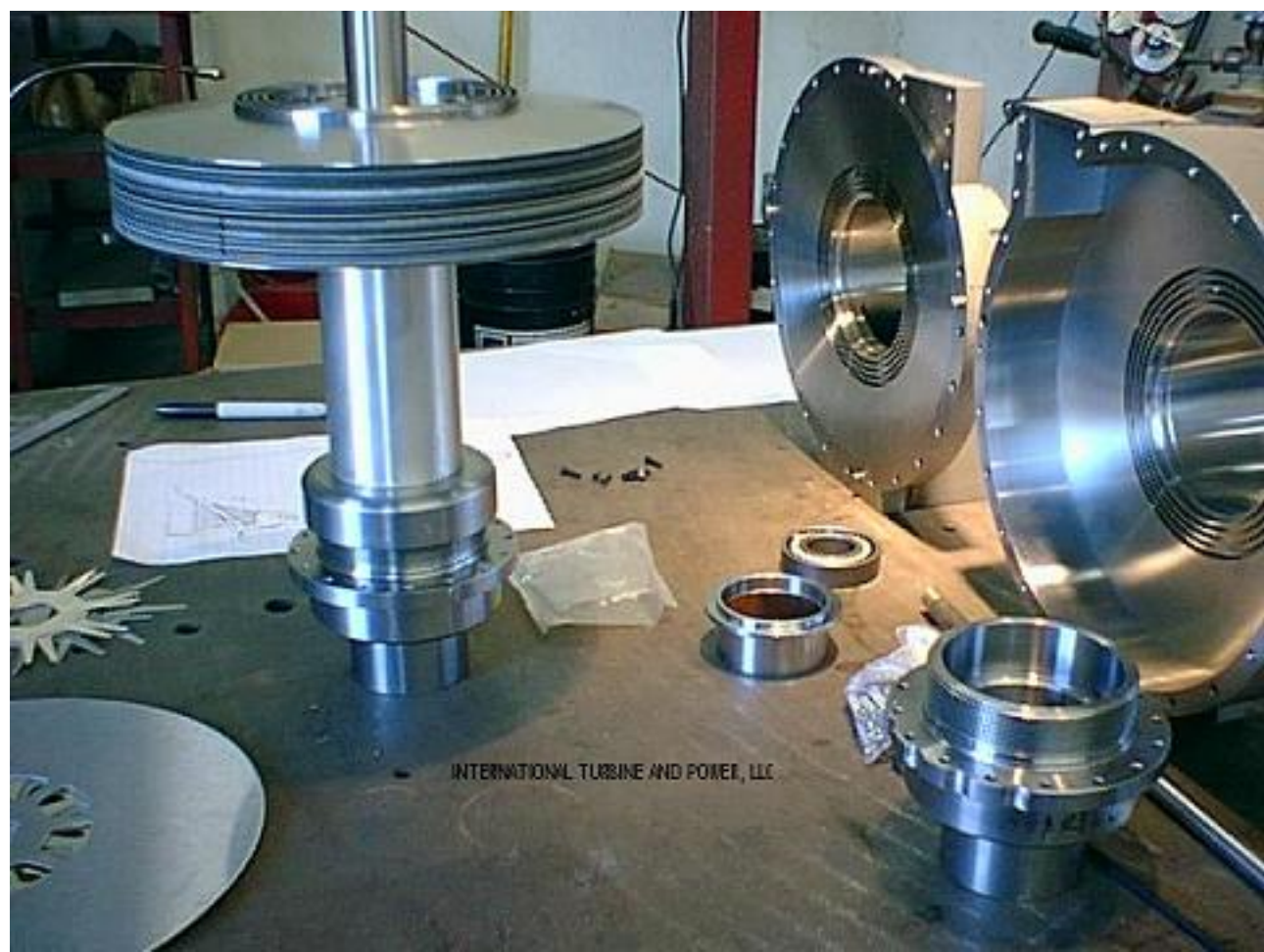





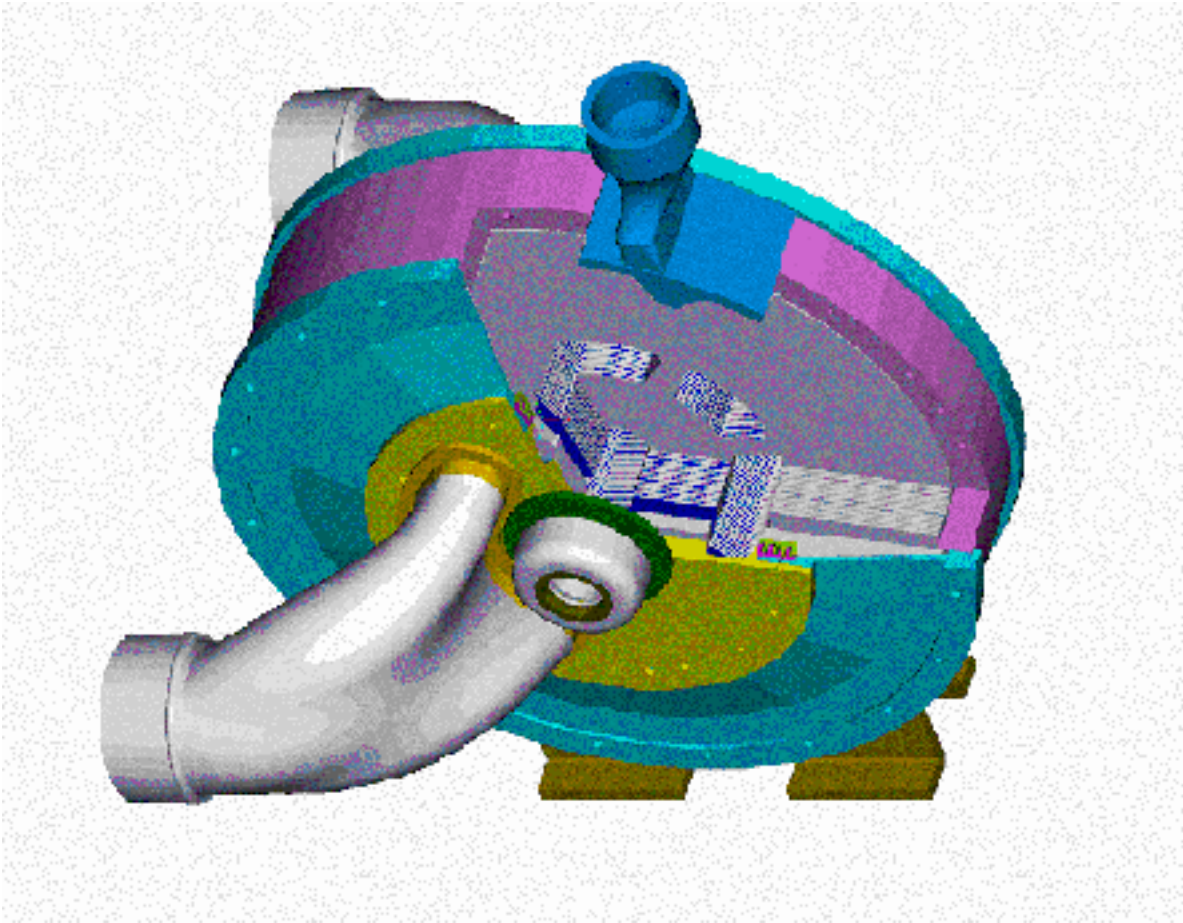

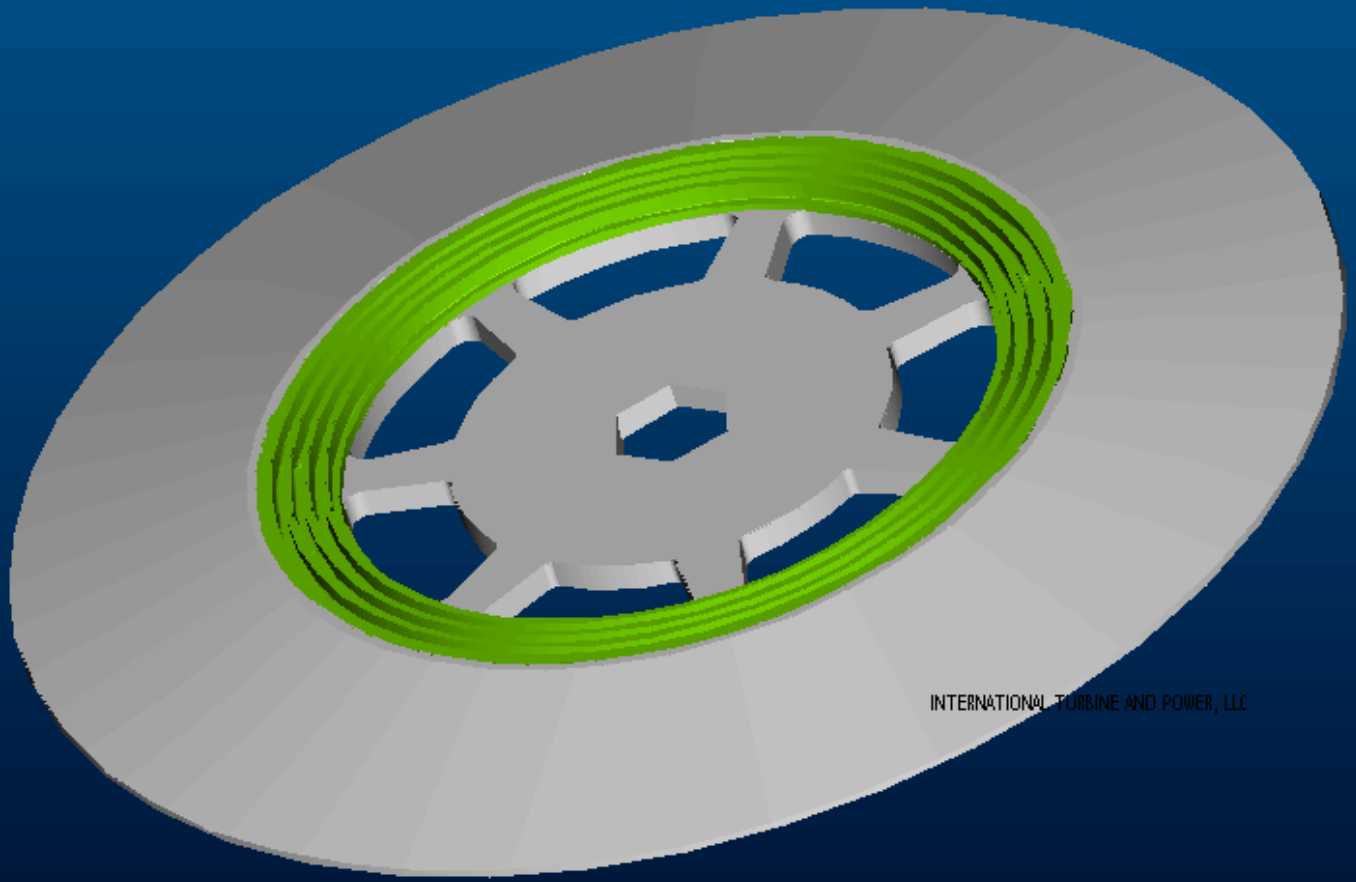

INTERNATIONAL TURBINE AND POWER, LLC

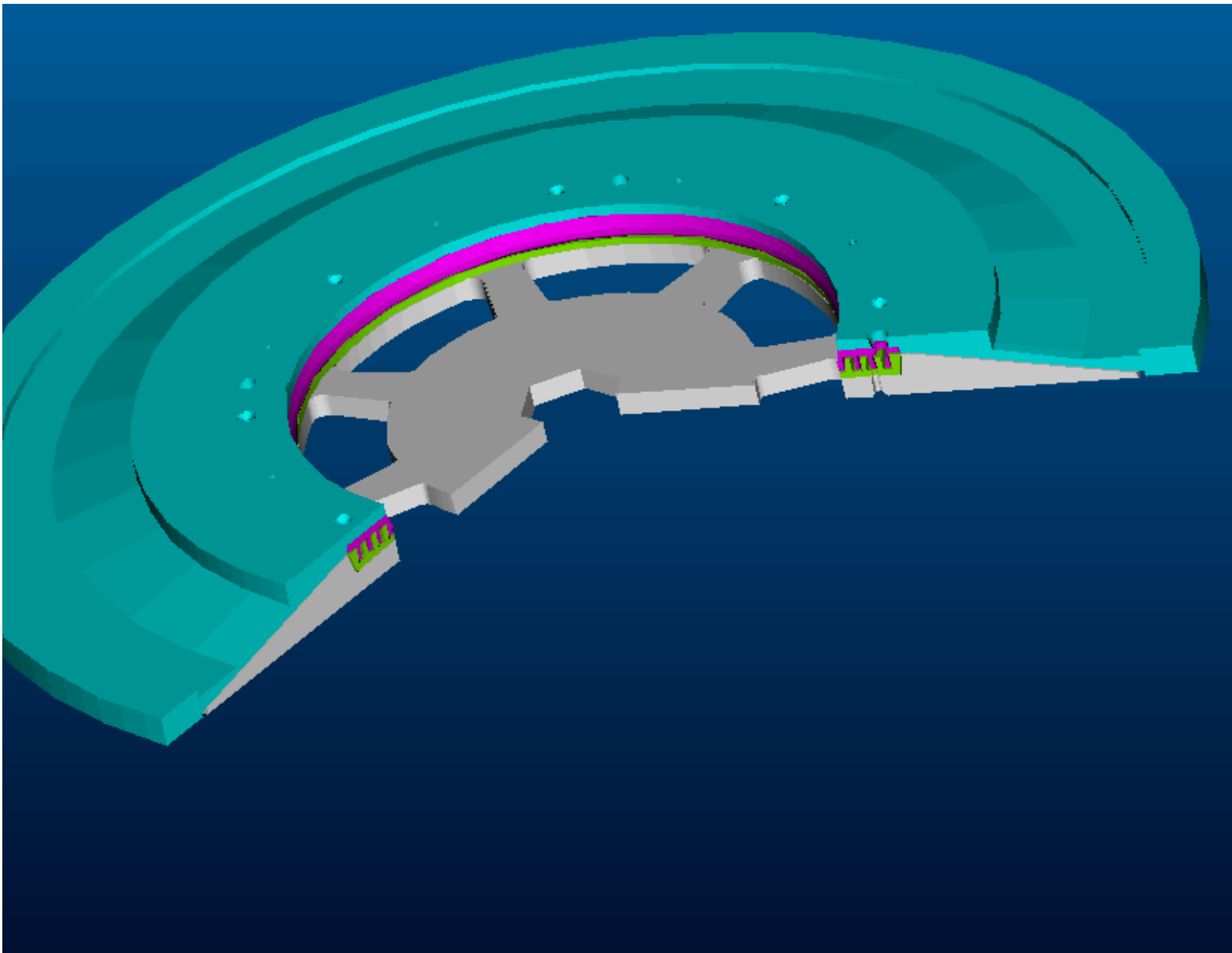

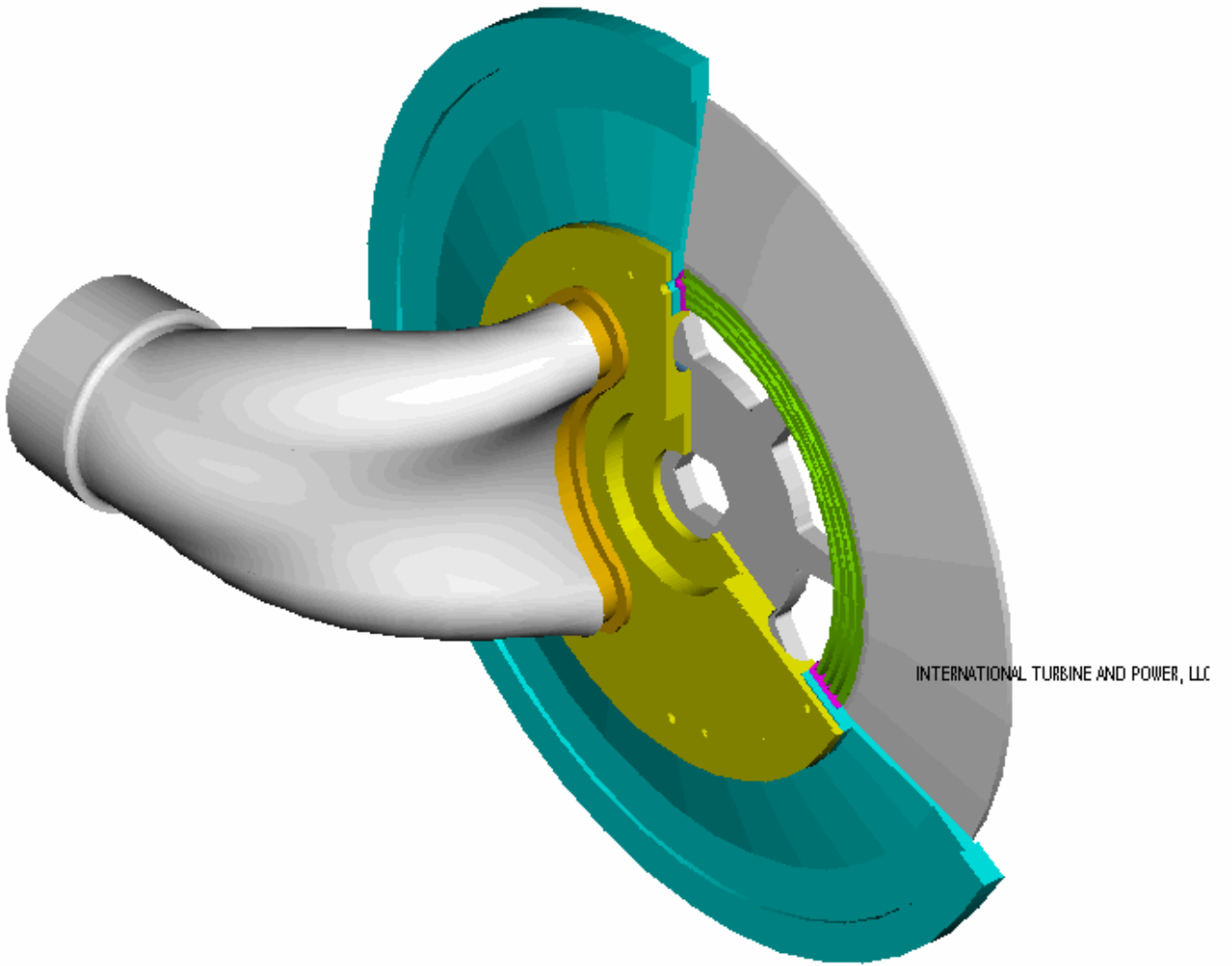



Guy Letourneau
33470 Chinook Plaza
Scappoose, OR 97056

1-Nov-01

Gary Beers
Fax:203-459-8697

Greetings:

On or shortly before 31-July-01, Mr. Frank Germano relayed to me the following test data observed during operation of the 'Charlie' turbine unit. This unit was expanding steam while shaft-coupled to a dynamo where horsepower from torque and speed could be observed.

DATA:

1. Ambient Conditions: 66°F (Std. Atm Press. assumed)
2. Turbine Input Observations, steam: 2" dia feed, 80psig, 270°F saturated steam, 800lbm/hr. [Metric figures: 653kPa abs, 132°C, 363kg/hr.]
3. Turbine Output Observations, steam: 204°F - 212°F, steam as a saturated vapor. [Metric figures: 95.5°C - 100°C]
4. Turbine Output Observations, Shaft speeds and Horsepower:

4000rpm: 2.2hp	7000rpm: 6.8hp	10000rpm: 7.6hp
5000rpm: 4.2hp	8000rpm: 7.2hp	12000rpm: 11.8hp
6000rpm: 5.8hp	9000rpm: 7.4hp	13000rpm: 14.8hp

ASSUMPTIONS, where made and stated, are conservative where possible, such as maximum available energy and minimum power observed. These assumptions are as follows:

1. From tables, saturated steam at 80psig [653kPa abs] should reside at 324°F [162°C] and not 270°F [132°C] as reported. Saturated steam at 270°F [132°C] resides at 42psia [332kPa abs] To assume higher available energy, the 80psig, 324°F [653kPa, 162°C] figure is selected.
2. While it is enticing to consider a possible vacuum state at the turbine outlet, as hinted by the 204°F [95.5°C] temperature reading for saturated steam at output, further verification of this output state should be investigated. For this report, although 212°F [100°C] was observed as high range and is a more conventional and expected value at standard atmospheric pressure, the lower output energy is assumed. Note that for this value, the turbine is operating within the vapor dome. Many observations by ITP, other Tesla-type turbine experimenters, and even the writings of Nikola Tesla himself confirm that water droplets within the turbine do not impede its operation. This is a strategic advantage over conventional bladed designs which are easily damaged by this mixed vapor/liquid condition.
3. To derive the output condition, the internal energy for saturated steam at 95.5°C [2500.9 kJ/kg] was applied. This is a lower and more conservative figure than the enthalpy of saturated but completely dry steam.
4. Steam output conditions assumed as the same for all tests. Therefore, 35hp (as calculated below) was assumed as the theoretical maximum available steam power.

CALCULATIONS:

1. Input enthalpy, from steam tables: 2760.3kJ/kg
2. Output enthalpy, from steam tables: 2500.9kJ/kg
3. Quality, from steam tables: 92.6%
4. Available energy 2760.3-2500.9= 259.4kJ/kg
5. Multiply by mass flow rate: 259.4kJ/kg x 363kg/hr ÷ 3600sec/hr = 26.2kW available [kJ/kg x kg/hr ÷ hr/sec = kJ/sec; 1 watt = 1J/sec]
6. 26.2kW x 1.341hp/kW 35hp available

(cont'd, next page)



EXPIRES: 31-DEC-02



7. Efficiencies (observed hp ÷ 35hp theo. max.)

4000rpm: 2.2hp, 6.3%	7000rpm: 6.8hp, 19.4%	10000rpm: 7.6hp, 21.7%
5000rpm: 4.2hp, 12.0%	8000rpm: 7.2hp, 20.6%	12000rpm: 11.8hp, 33.7%
6000rpm: 5.8hp, 16.6%	9000rpm: 7.4hp, 21.1%	13000rpm: 14.8hp, 42.2%

8. Theoretical efficiency at maximum operating speed:

One of Nikola Tesla's prototypes a 9.75" dia unit, is very similar in design to our 10" dia 'Charlie' unit. Tesla's device was tested at 18,000rpm, which is our desired operating speed as well. Conservatively extrapolating from the data above, a best-fit line using the observations at the highest four speeds will project an output of between 23hp - 28hp. The efficiency of the lower of these two figures approaches 66%. It is to be emphasized that this is a theoretical figure, based on all other operating conditions remaining constant. Nevertheless, Nikola Tesla himself claimed a maximum theoretical figure of nearly 97% for his 9.75" dia unit.

I certify under my professional licensure that these input data are correct as reported to me, and that the calculations as based on the assumptions stated above are true and correct to the best of my knowledge and engineering practice. In my professional opinion, further experimentation and verification of assumed energy states and operating conditions is advisable, before claiming these figures as fundamental output specifications.

However, I also remain optimistic that a disk turbine of the 'Charlie' design will produce superior efficiencies under certain controlled operating conditions.

Sincerely,

Guy Letourneau, PE
InBPEL #19400289, OSBEELS #18774
International Turbine and Power, LLC.



EXPIRES: 31-DEC-02

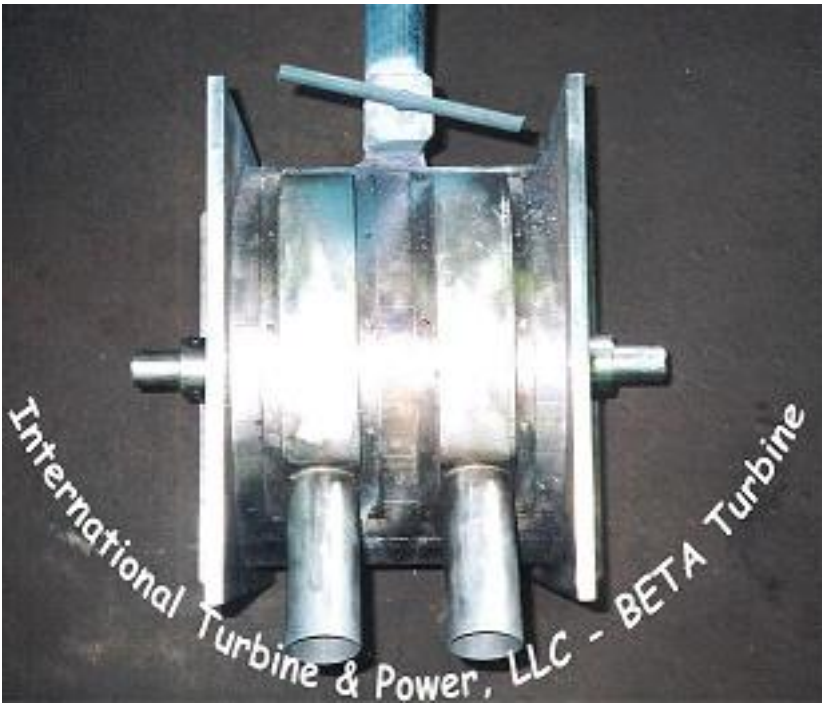



International Turbine And Power - BDT - Charlie Series

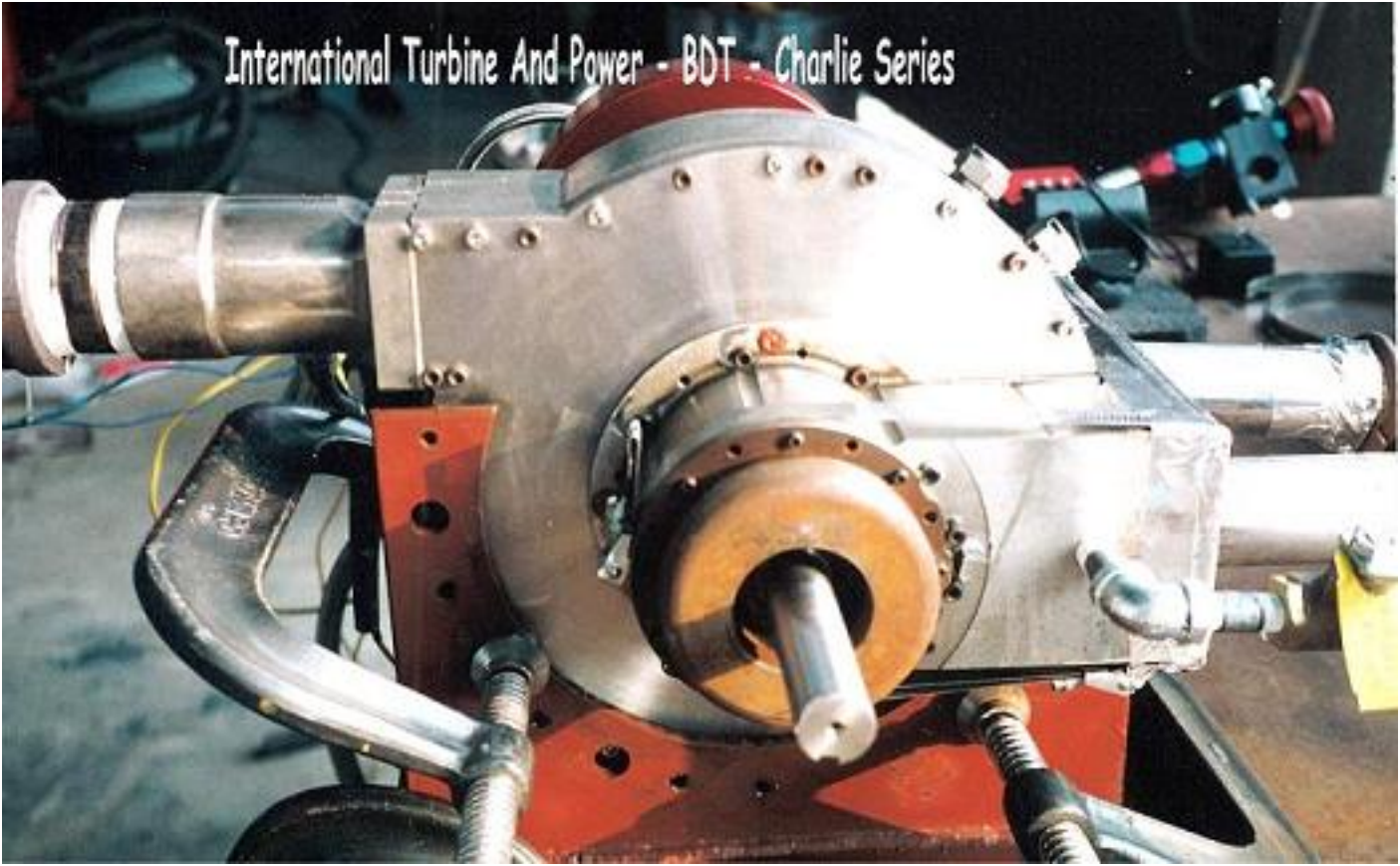

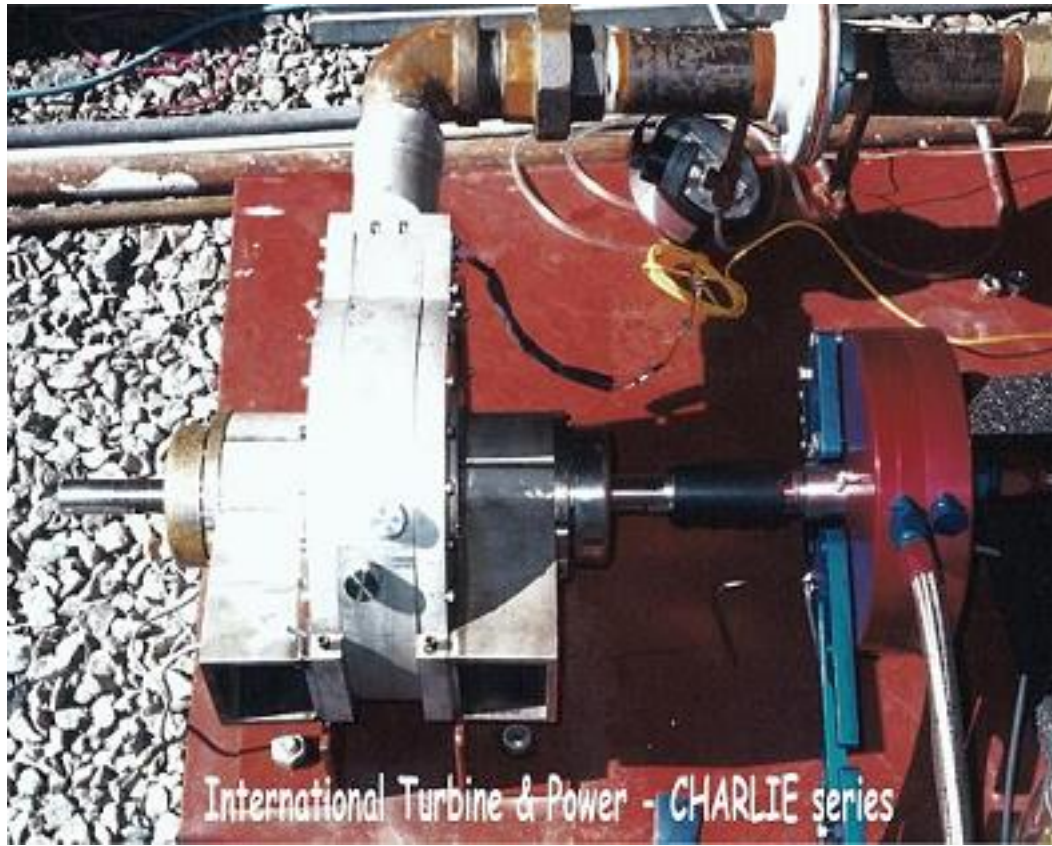

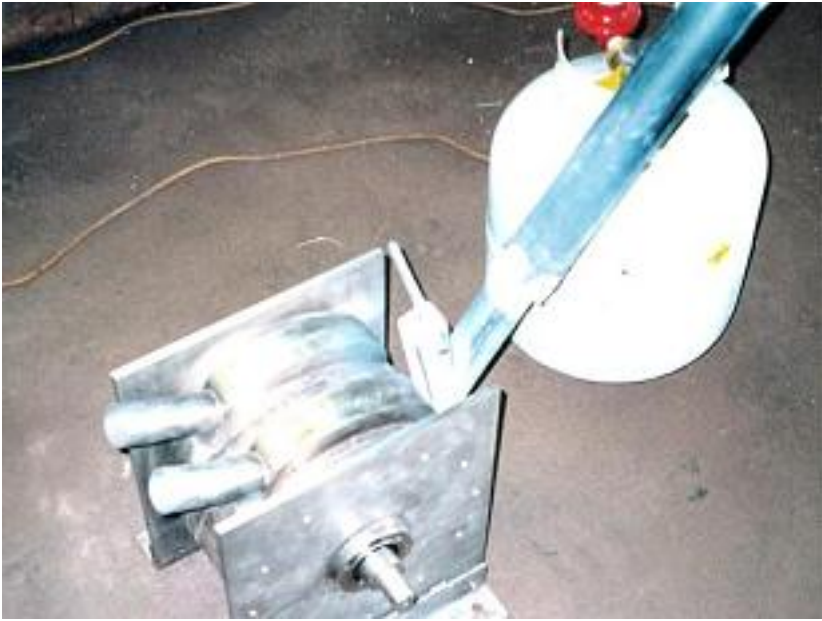

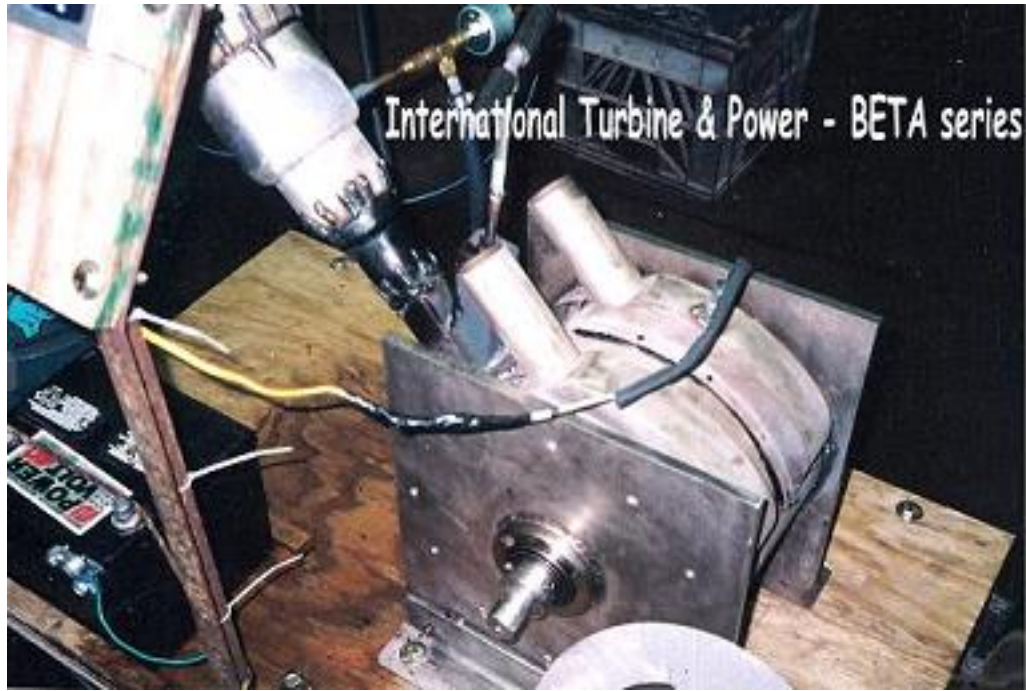

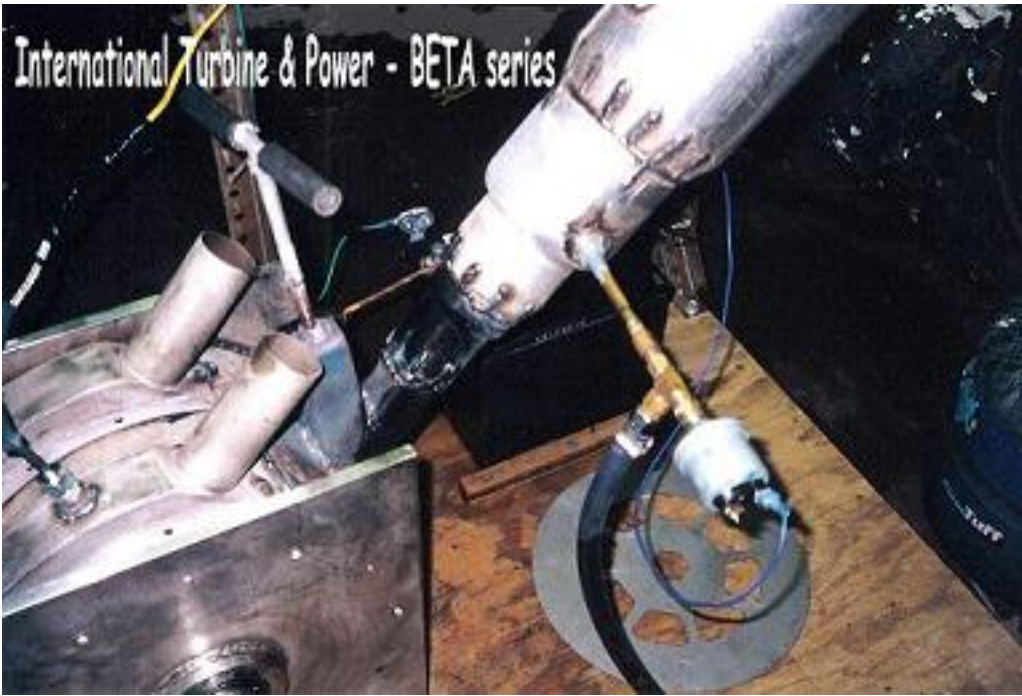







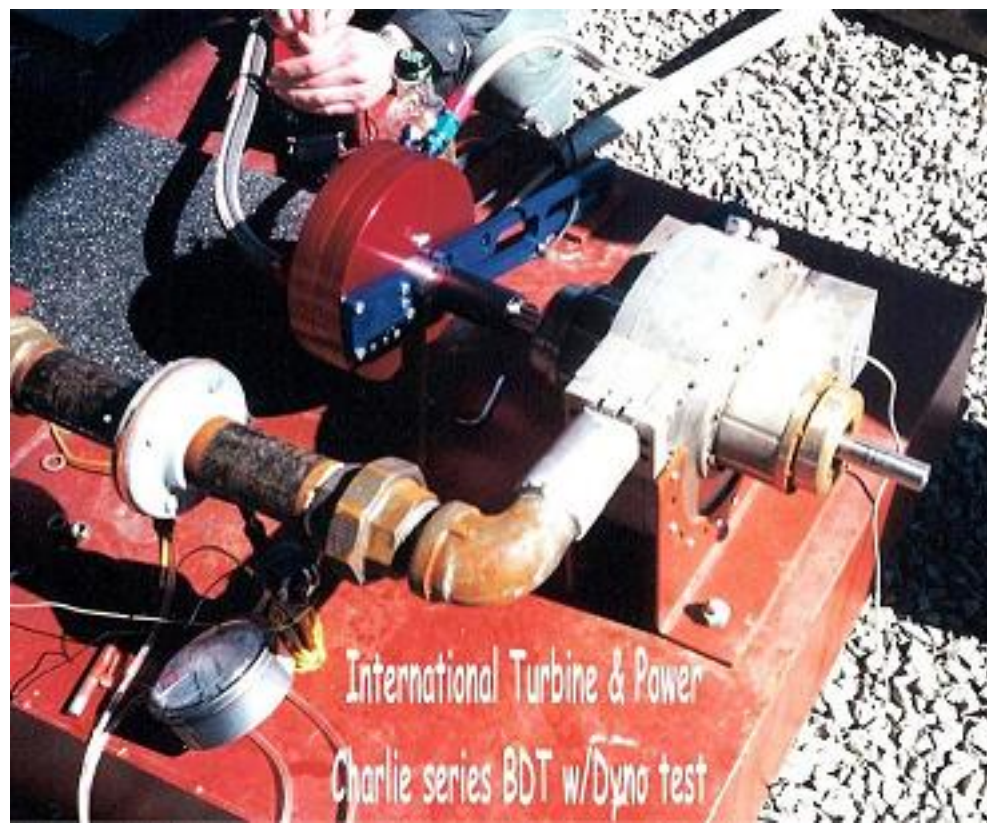



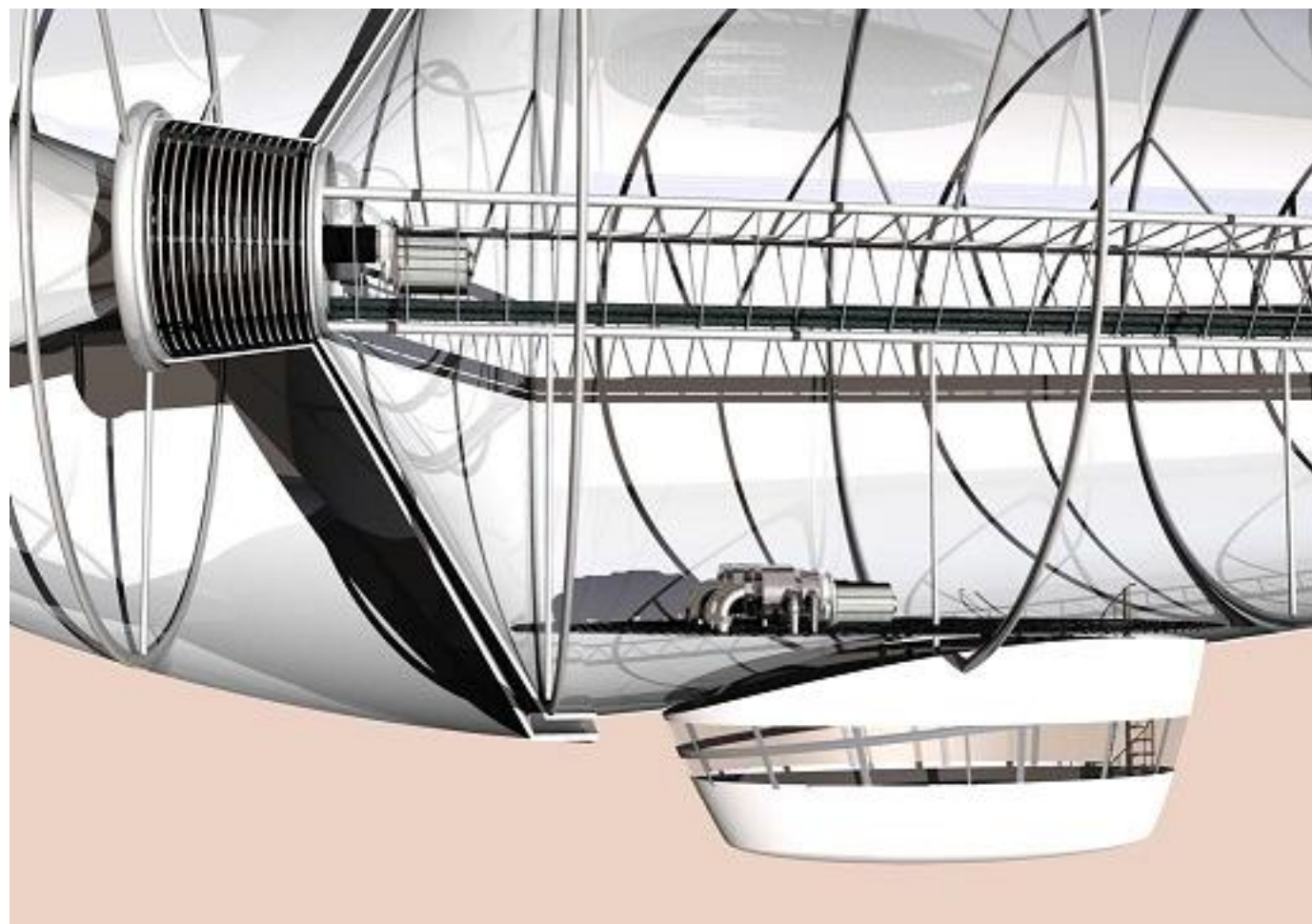

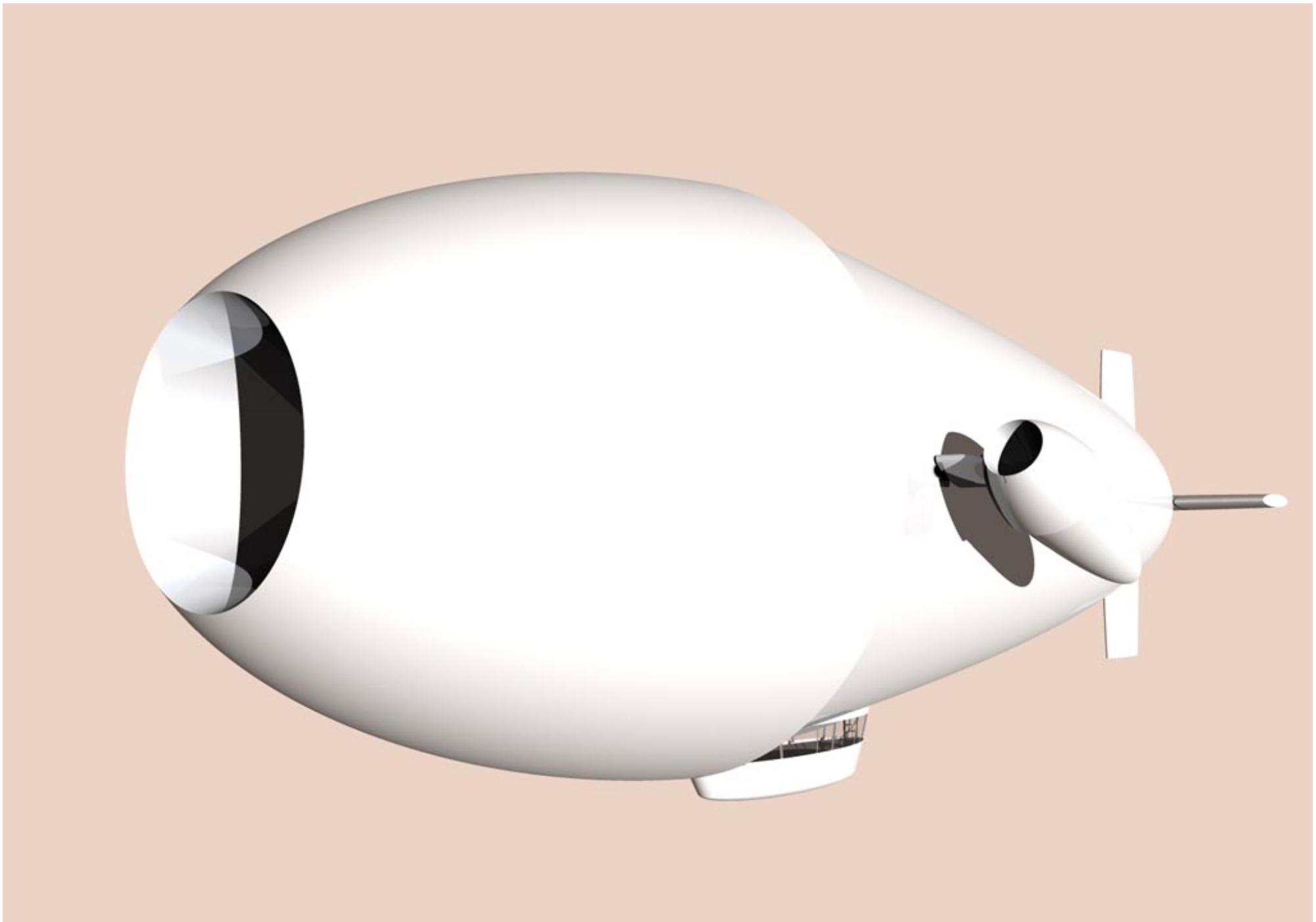

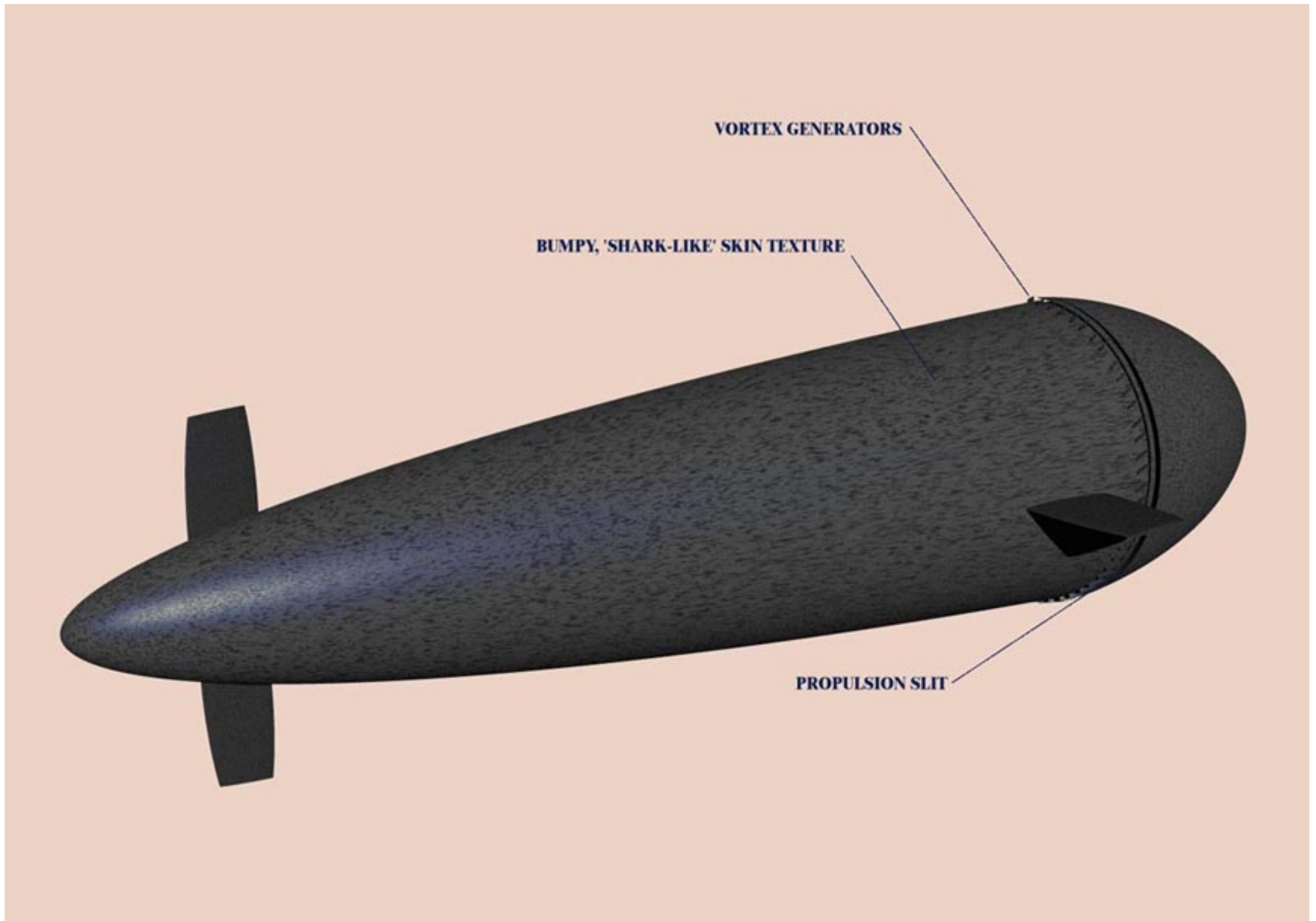

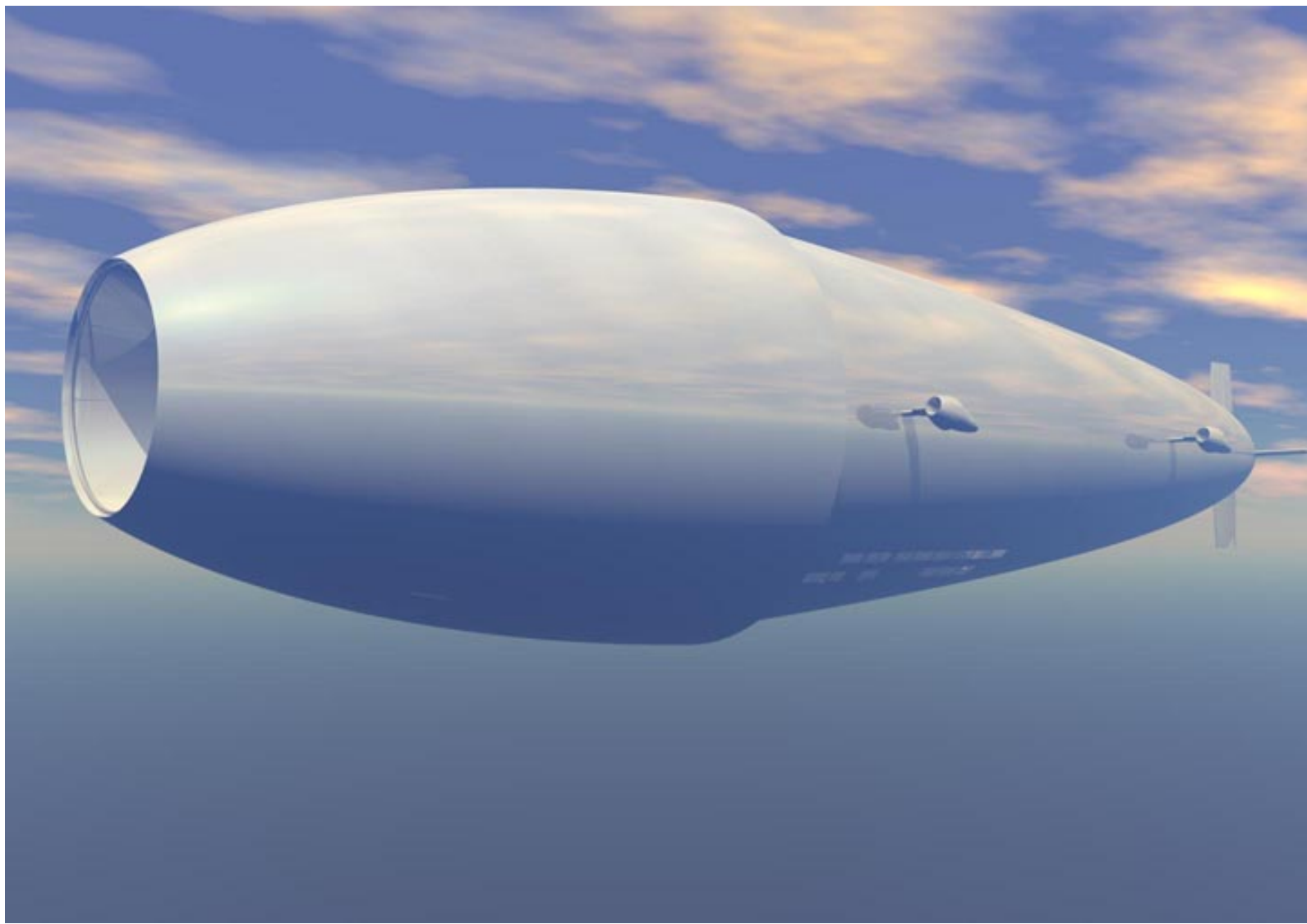

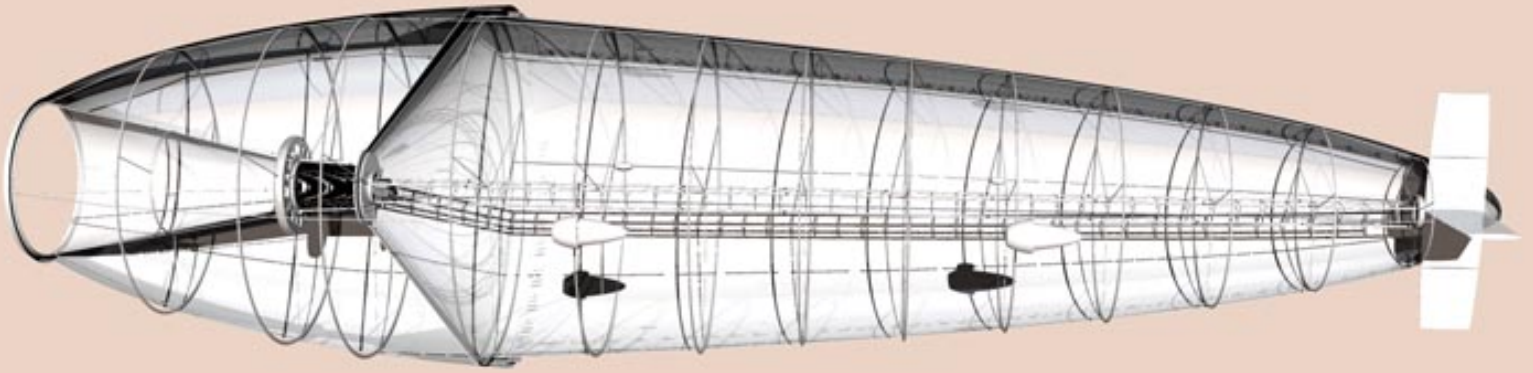

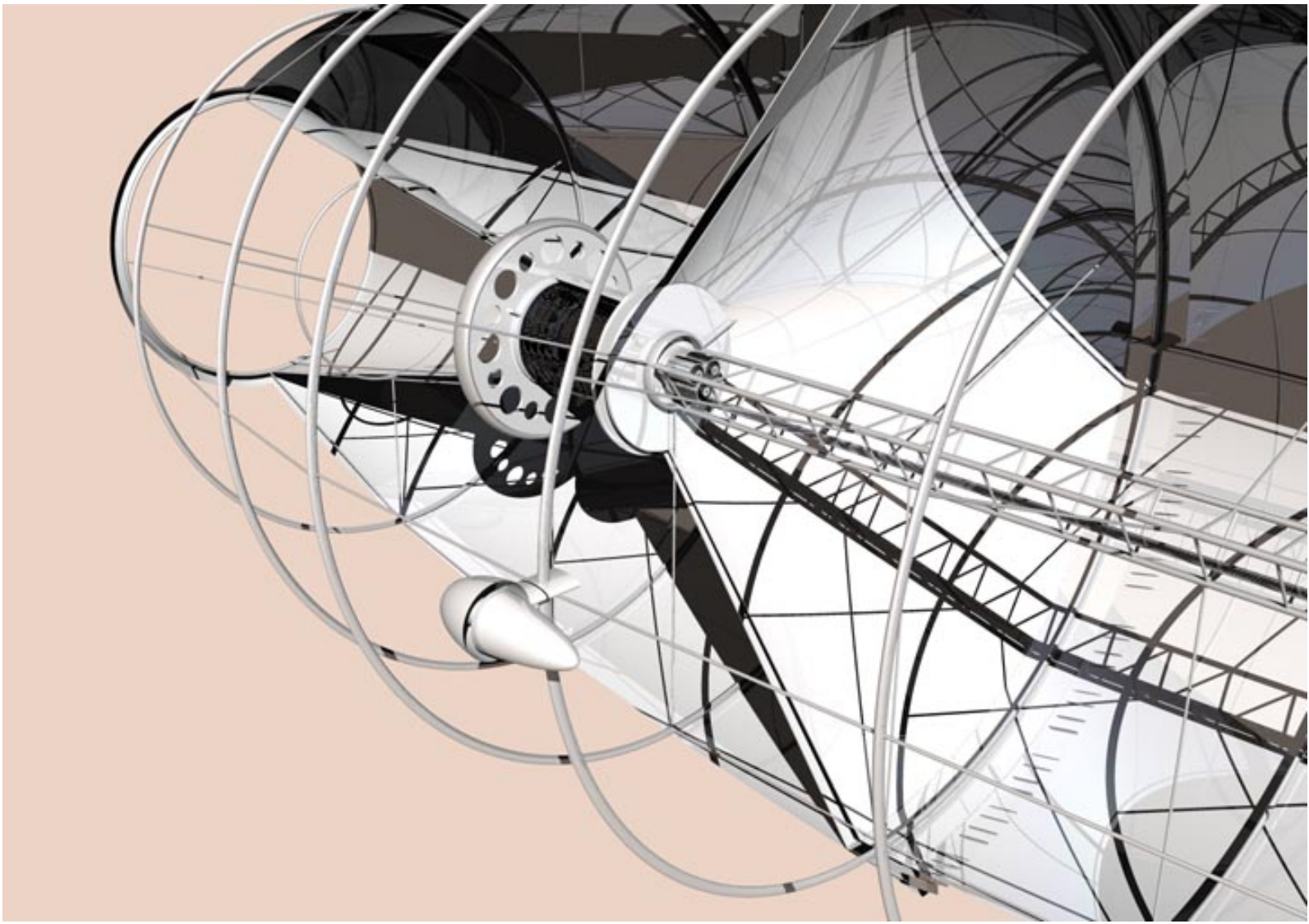

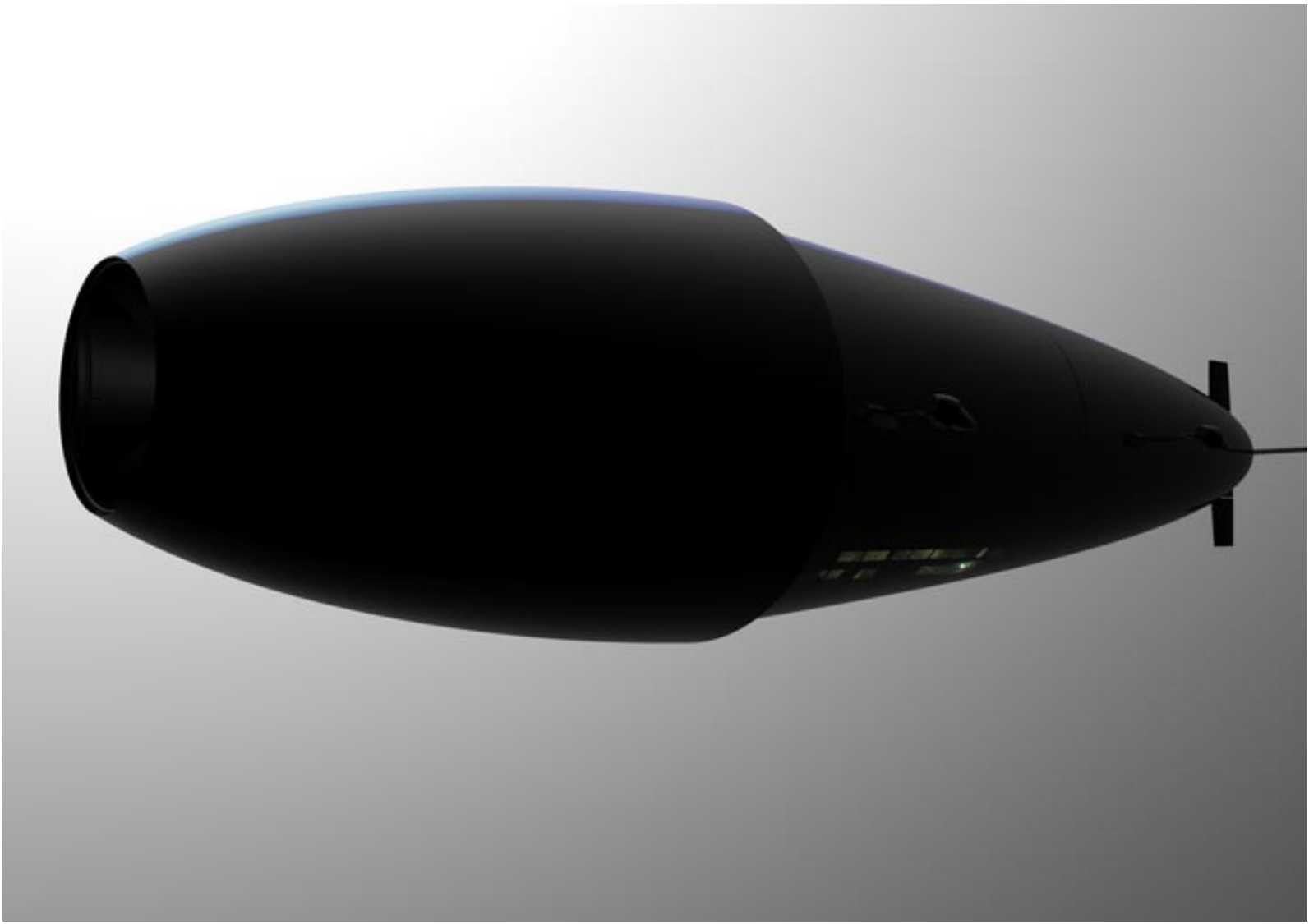

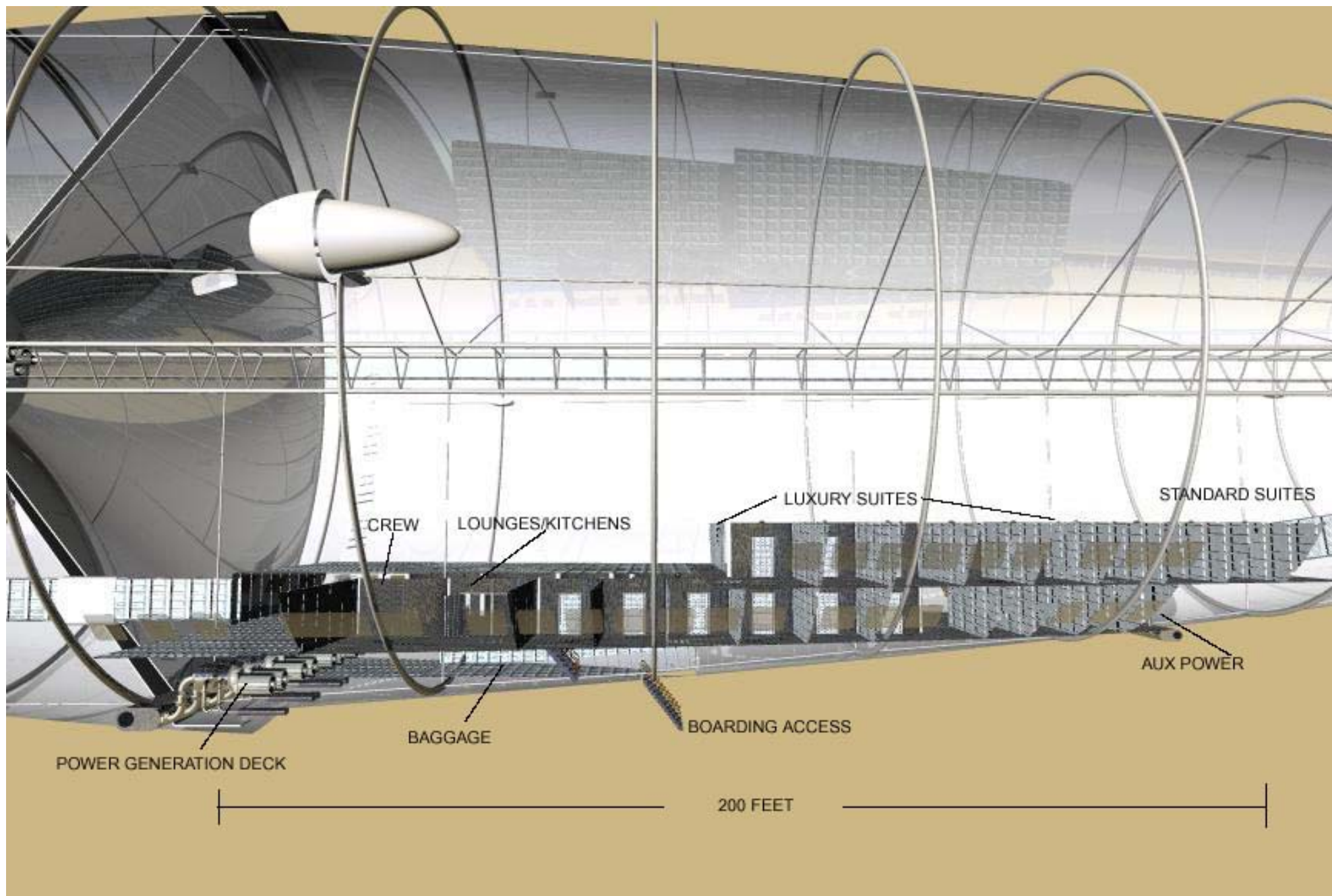

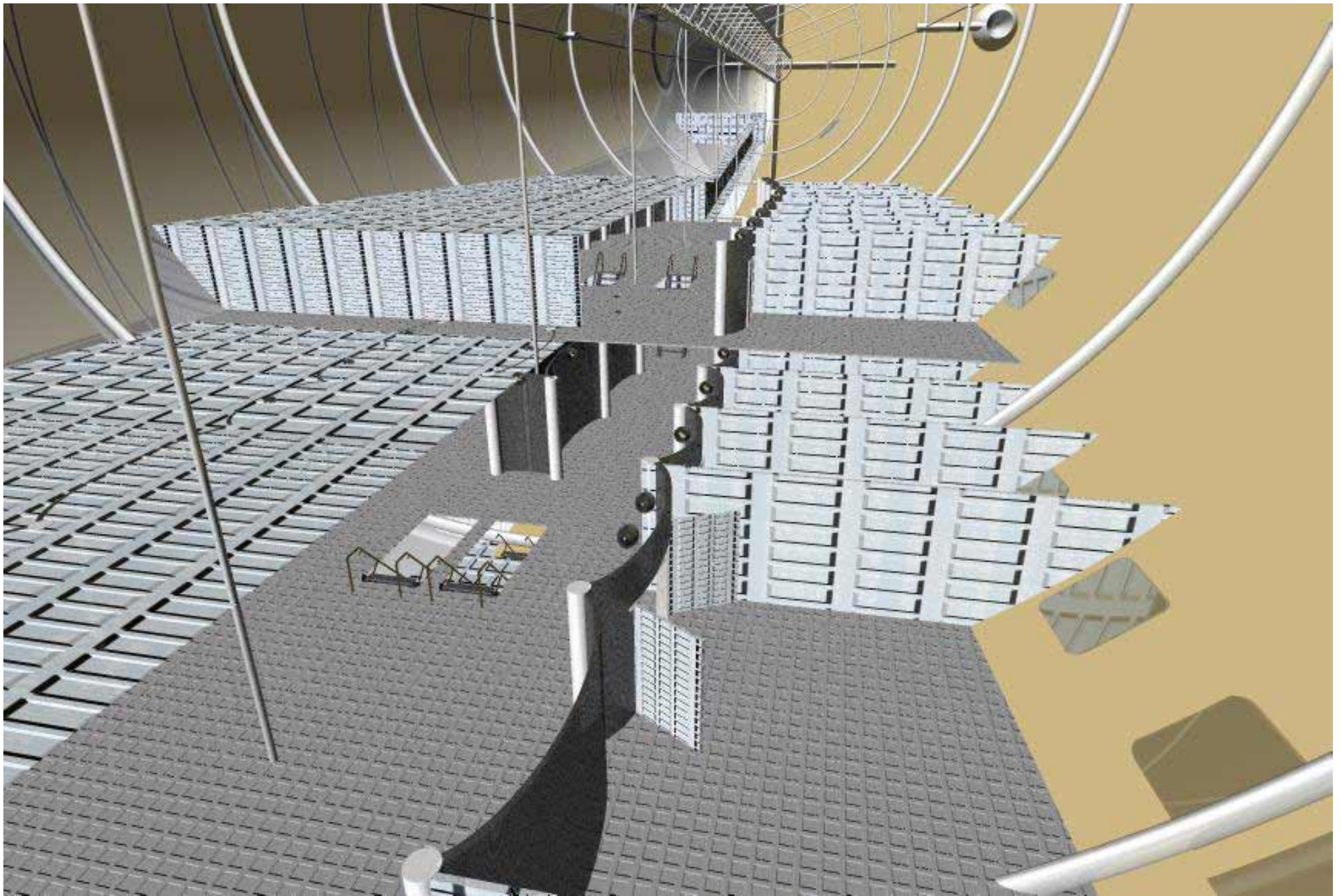



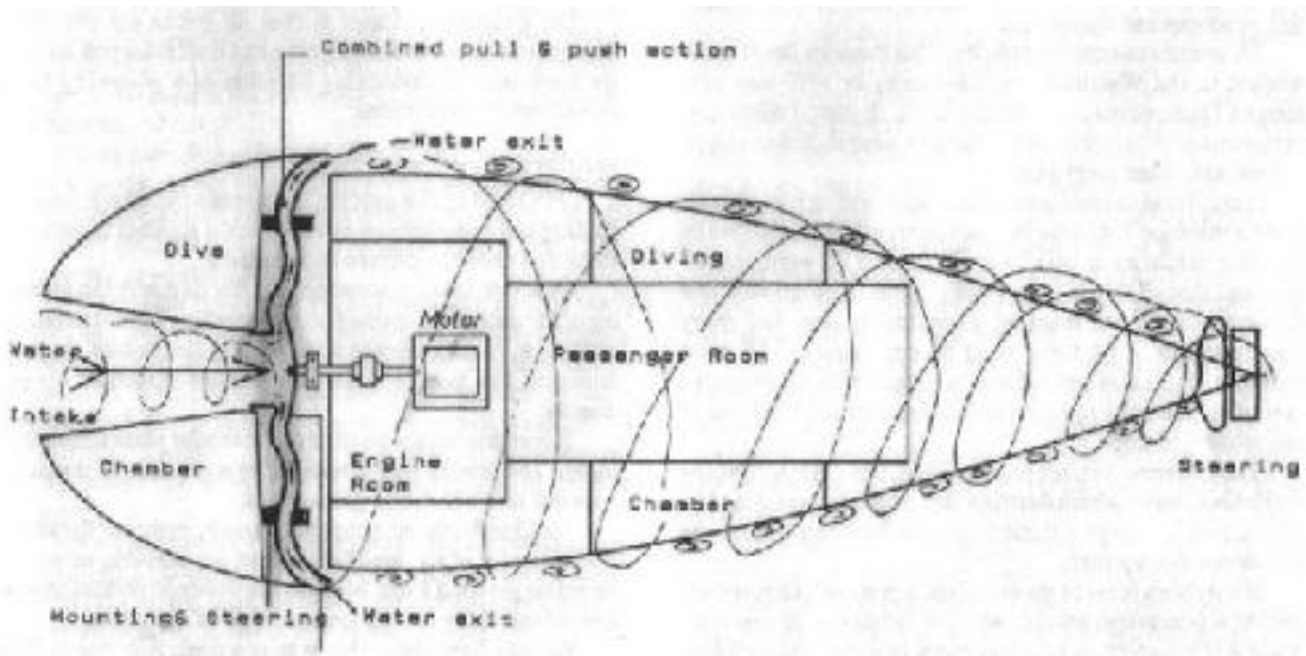

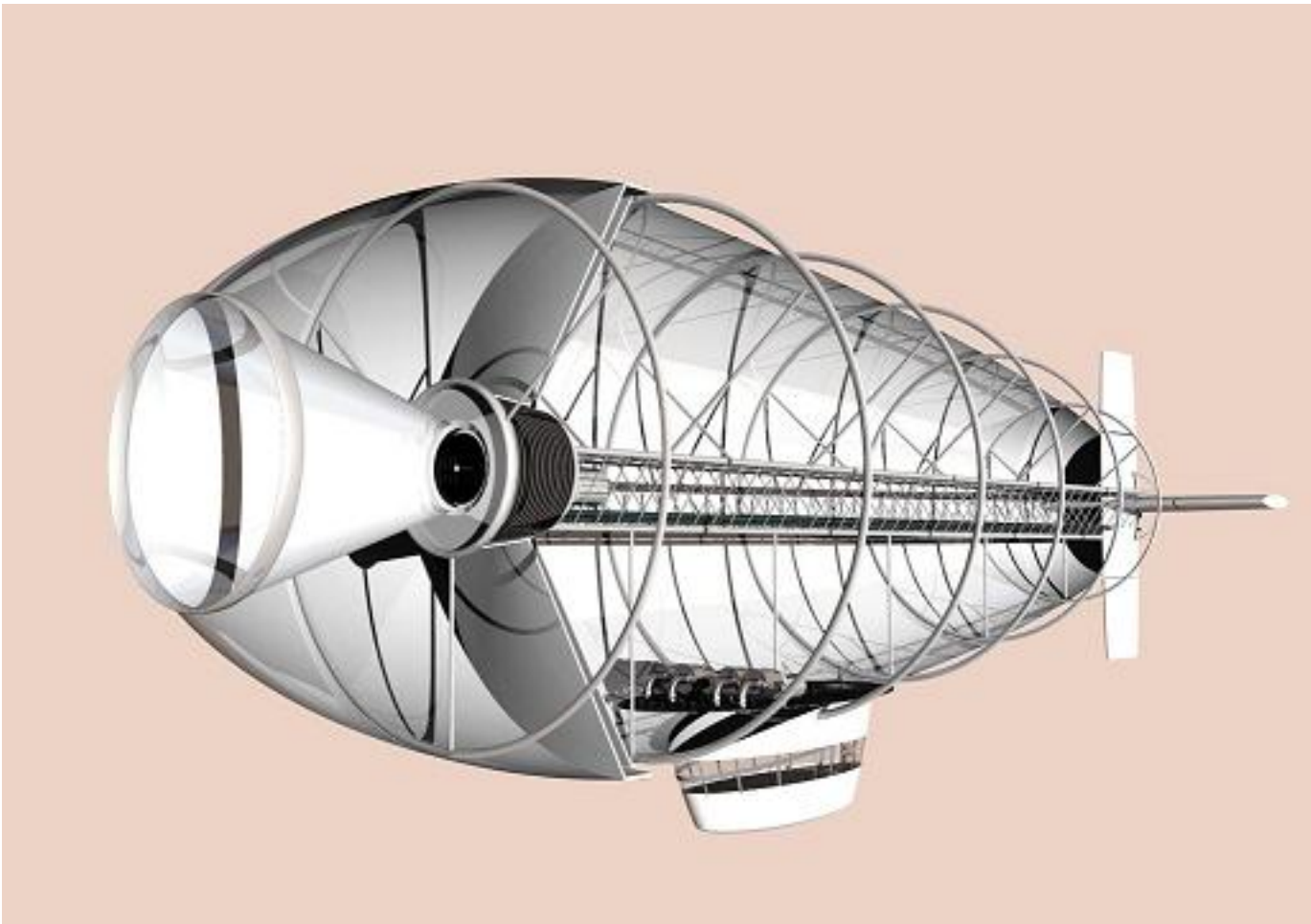

How Can YOU help?

"Ask, and you shall receive...?!"

This website and the company that was formed was the result of a dream - "can someone bring Nikola Tesla's and Viktor Schauburger's inventions to light?" We've come pretty darn close, haven't we?! So how can **You**, yes - the average person reading this website, in fact **help** bring this technology to the world? I'll explain:

- 1.) The simple fact is this - **International Turbine And Power** is/was an R&D company. We have had many breakthroughs with technology innovations and we have virtually created "turn-key" systems which are now ready for commercial release - the Tesla Turbine and Pump (our "CMiT" and BDP systems, "InVAID" and BDT systems) can be brought to the public within a minimum time frame. With new investor monies applied, ITP would incorporate, and make a public offering.
- 2.) We have been funded for the most part by private investment monies and personal funds.
- 3.) It costs a considerable amount of money to sustain this research. It will cost considerably more to bring this technology to the commercial markets.
- 4.) This is where you, the average reader of this website, come into play. Investment dollars, donations, or just showing your support, can all make a big difference in how quickly we are able to offer this technology to the public. The question that you, the reader, has to answer is - would this technology make a difference in MY life? Until a suitable, environmentally sensible new means of generating electrical power is found, we face a very uncertain future. Our environment will, at some point in time, no longer be able to support our wanton disregard and rampant pollution. This must change if our children, and our children's children ever expect to live on planet earth. The technology exists - now - to offer clean, environmentally sensible power generation in the form of utilizing the Tesla Turbine with the Schauburger vortex inducing water power generation systems.

So...if you enjoyed reading the material presented on this website, if you learned something new from it, or if you are **not** "financially challenged" (!) and feel you would like to help support the continued research - we need your hard-earned money. Send whatever you can afford. Don't be shy. This is definitely my twist on the "ask and you shall receive" challenge. Send that Dollar...send Five dollars...send Ten Dollars, or Twenty... send a Hundred Dollars. If you are extremely wealthy, send **allot** of dollars!. If you simply **know** of someone that is wealthy (i.e. a movie star, a music star, a philanthropist) **tell** them about us and how we are ready to release this fantastic technology to the world. Get them excited about this technology and how it is ready and waiting. If we think of all the concentrated wealth that is held by music entertainers,

actors, the movie industry, the sports industry and its team members and players...if only a small fraction of those people got actively involved and contributed monies, we could effectively change our very planet in an extremely short time frame. It is not the technology holding us back - it is the money necessary to build and install this technology.

The amazing fact is that this country (The United States) can spend millions of dollars each and every weekend going to see the "newest" movies that come out, yet how much money is being spent on things that may determine our very capability to survive into the next century? To date, in our technological world, we are controlled by the all-encompassing power of the Oil Industry driven economy. This will be proven to be an un-acceptable situation in the near future. We will not run out of fossil fuels...we simply will not be able to LIVE on this planet with the pollution we are creating. There is a much simpler, and economically feasible solution - use water power (hydro-powered systems)! This is not "sci-fi" - it is simple, proven mechanical engineering principals. Both Nikola Tesla, and Viktor Schauburger were strong advocates for using hydro (water) powered systems, as the only **logical** means for generating electrical energy.

It's only a matter of money, and that's where this webpage comes into play, before this technology becomes commercially available. The simple fact is that it is not really that much money, either - how much (?) - on a low end - 2 million dollars...for a fully-funded market launch - 7 million dollars. In today's world of big-business, that's peanuts. It's sad that with all the money being thrown away on pretty much useless things...this technology will have to wait until this measly amount is gathered and put to good use.



Tesla's and Schauburger's dreams have not ended. I maintain that this technology is applicable, and practical, and can offer a better quality of life to so many people, particularly in third-world countries. I can do this, but not without your help and support. So, if you find it in your means to send money our way, it will go towards that goal. This money will go towards supporting the continued research and development of this project. When that day comes, as I am sure it will - Tesla's dreams of a "new tomorrow" will be realized. Let's hope that the multi-billion dollar "big" companies can handle it...because, with or without me and my company - THAT DAY WILL COME, when free "clean" ecologically sensible, boundless energy will be readily available to all. To that end I work.

Frank D. Germano.

You can send your money to either a US Mail address, or use "PayPal" for online convenience. Every nickel, dime, quarter and dollar helps in funding this continued research.

Thanks.

for "PayPal" on line payments: go to -

<http://www.paypal.com>

and request to send money to my email account - frank@germano.com

or use these easy links -

if you prefer to send money via US Mail:

Frank Germano
HC 1, Box 1887
Tafton, PA 18464

Many people have asked "who" is on my favorites list of "superstars" I'd like to work with, so here they are: Richard Branson (Virgin Records and Virgin Airlines founder... numerous attempts at around the world hot air balloon flights, owner of his own private Caribbean island...my kind of guy!), Michael Jordan, Bruce Willis, Nicholas Cage, Steven Spielberg, George Lucas, John Travolta, Brad Pitt, Vince Neil & Tommy Lee (members of 'Motley Crue'), 'Tesla' (the band), Bill Gates (who wouldn't like to have Bill's funding?!), Donald Trump ("The Donald" could make this technology a "household" reality quite easily - take up the challenge, Mr. Trump!), William Shatner, Leonard Nimoy, Vice President Dick Cheney (can anyone say "Halliburton"?), Sting (eco-friendly rocker!), Paul McCartney (big on environmental issues), Oprah (with almost a billion dollar enterprise, Oprah could handle the task quite easily), Steve Tyler, Mick Jagger, Jon BonJovi, Tom Cruise, Bono, Tom Hanks, Kevin Costner, Garth Brooks, Tom Hanks, Arnold Schwarzenegger (the new governor of California would be amazed that his entire STATE could be powered from geothermal sources - all pollution free!), Warren Buffet, Willie Nelsen, Steve Jobs (Steve is always on the cutting edge!), P-Diddy (Puff Daddy has the money and money making ideas like no one else, these days), Justin Timberlake, Sheryl Crow, Britney Spears (hey...I'm a guy, after all!)...and anyone else who not only has the financial means to help, but also the desire or the political clout to DO something worthwhile for the world. The point of even putting these names up here is this - no matter HOW much wealth these people process, it doesn't mean a damn thing if there is no planet left resource-wise to live on. Our fresh drinking water supply, our breathable atmosphere, and our natural ecological systems are being depleted at rates that will ultimately cause this planet earth to be unlivable within the next few decades. Think about it.

"Through our partnership with Amazon.com, we are offering an exclusive Frank.Germano.com version

of the award winning Alexa Toolbar. This toolbar is a great way to surf the web because it constantly provides you with Related Links. It's a great time saver! Plus, when you download and use the toolbar, you'll help support Frank.Germano.com."



It happened once - Nikola Tesla's and Viktor Schauberger's dreams and inventions were almost erased...please help me in not letting this ever happen again. FDG.

[Back to INDEX](#)

email me:



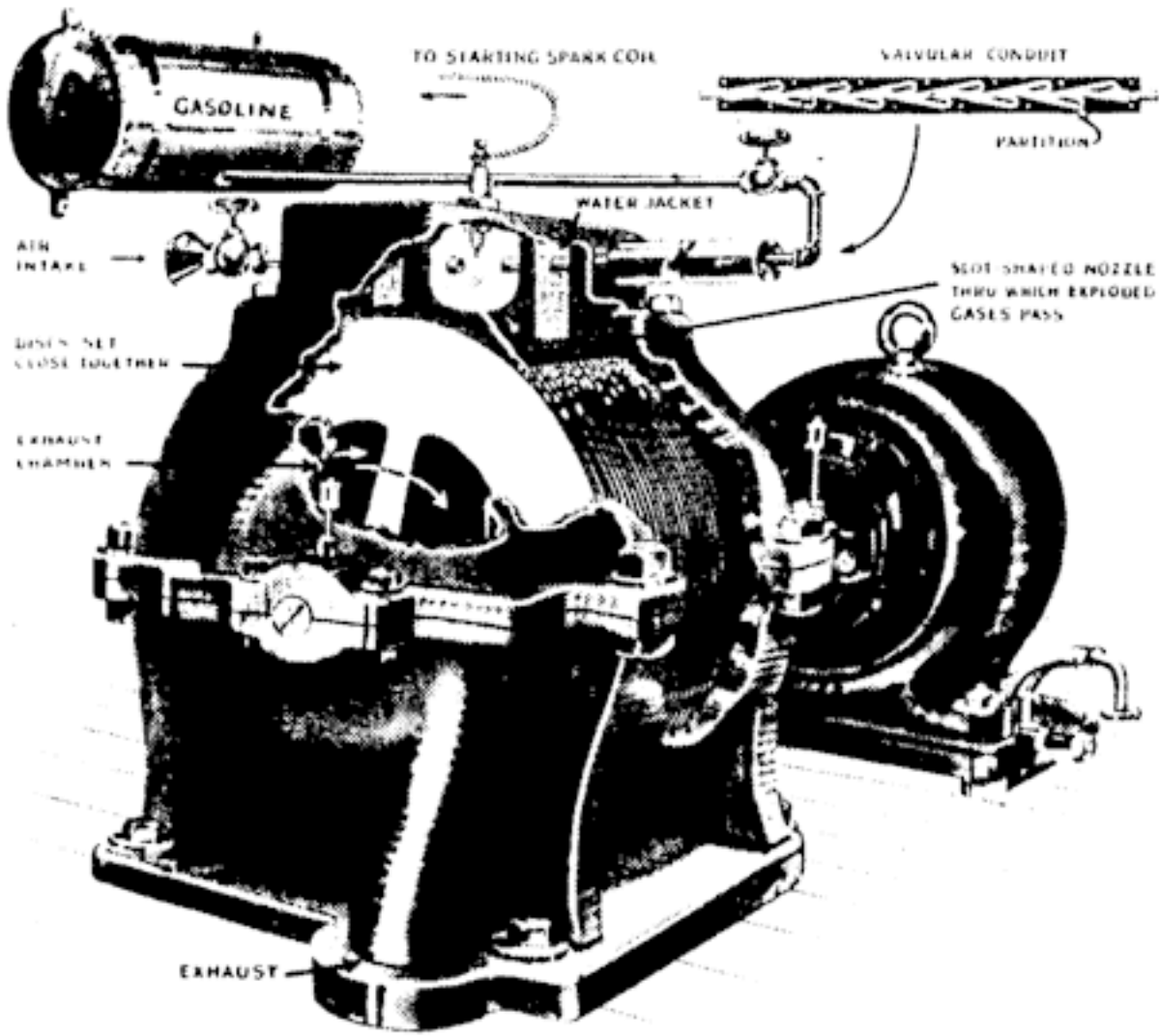

The Tesla Gasoline Turbine - a simple and practical gas engine.

NIKOLA TESLA'S DISK TURBINE

Tomorrow's Gas Engine Is At Our Doorstep

Since its invention more than 100 years ago the reciprocating explosive gas engine has handily served mankind as we have sought to replace raw muscle power with that of the machine. In this type of motor a linear motion is given to one or more pistons by the compression and explosion of a combustible mixture of vaporized fuel and air. The energy released by the explosion is transmitted to a crank shaft which converts the reciprocating movement into rotation. With the passage of time the primitive device of the 1860s has evolved into a complex marvel of machinery capable of propelling an automobile at speeds in excess of 300 mph and yet it still bears the same basic configuration and the same mode of operation as that of its earliest ancestor.

An alternative to the reciprocating engine is the rotary engine. The most common form of these machines, the conventional bladed turbine, is used for everything from the propulsion of aircraft and large ships to stationary power generation. While working in a somewhat different manner as the machine described above, the end result of its operation is still the same - the creation of torque. Among the advantages to be gained from this design option is a reduction in the number of moving parts. In the rotary engine the piston, connecting rod, crankshaft, and flywheel are replaced by a single moving component known as a rotor. In direct contrast to the typical reciprocating engine, a well balanced rotary engine will operate virtually without vibration. Other advantages include an increase in power to weight ratio and better fuel economy. On the other side of the coin, bladed turbines are highly precision machines built to very close tolerances, and thus are much more expensive.

Nikola Tesla's disk turbine, which is said to approach the ideal rotary heat engine, can be viewed as an inexpensive alternative to the bladed turbine. It consists simply of multiple shaft mounted disks suspended upon bearings which position the rotor system within a cylindrical casing. In operation high velocity gases enter tangentially at the periphery of the disks, flow between them in free spiral paths to exit, depleted of energy, through central exhaust ports. The slight viscosity of the moving gas along with its adhesion to the disks' faces combine to drag them along, efficiently transferring the fuel's energy to the disks and on to the shaft.

The central component of this unique engine, the rotor, is built up using eight basic components: ported disks, star washer spacers, ring washer spacers and rivets, all of which constitute the runner subassembly, and the rotor shaft with its shaft keys, bearings and lock nuts. Fabrication of the runner is fairly straight forward. The parts are assembled with the aid of a stub shaft that has three key ways machined in it to line up with three complimentary key ways machined in the center hole of each disk. The stub shaft's length should be about three times the intended width of the runner. One end of the shaft is threaded and a shoulder ring is fastened just over a third of the way in from that end.

Assembly begins by slipping one of the thicker end disks on to the shaft. With the rivets inserted the first set of spacers are installed followed by the first thin disk. Additional spacers and disks are added in sequence with the second end disk going on last. (An operational note: In addition to providing spacing and support to the disks, each ring spacer also adds a small amount of lift that helps to propel the runner around.) At this point half a dozen or more "C" clamps are used to compress the subassembly so the rivets can be tightly peened down. The next step is truing up of the runner's width with a surface cut across the faces of the two end disks.

While it is not as critical, the runner's outside circumference can also be trued up at this point. Care should be exercised here to reduce the chance of damage. Any burrs and irregularities can next be removed with a narrow cutting tool. Now that the runner subassembly is nearly completed all that remains to be done is to remount it on the actual motor shaft for dynamic balancing. This is done with the aid of sophisticated machinery through the removal metal from appropriate locations around the runner's perimeter by the drilling of shallow holes near or directly into the outer edges of the end disks.

As a starting point, the thickness of the spacers and thus the dimension of the intra-discular space can be approximated using the depth of boundary layer of air adjacent to the disks' surfaces. The boundary layer's true depth will depend somewhat upon the temperature and density of the propelling gas. Drawing on the science of aerodynamics we learn that the boundary layer on the skin of an aircraft in flight is approximately .020 of an inch in depth.

So, it can be assumed the layer on each side of the disks is nearly .020" thick also. If the disk spacing were to exceed .040" there would be a space through which some of the propelling fluid could flow and fail to effectively interact with the gas molecules making up the boundary layer. Reduce the spacing to .040" and the two layers could be said to come in contact with each other. This sets the maximum limit of spacing. With a spacing of .030", a standard thickness of 304 stainless sheet stock, the two layers would overlap by .010". The practical experience of at least one disk turbine builder lends support to the use of .030" for the thickness of the spacers and the disks as well.

The engine rotor housing or casing as described in Tesla's turbine patent consists of two basic elements, not counting seals. These are a central ring casting and two end plate castings to which the flange pillow block bearing assemblies are bolted. As can be seen from the figure an alternative configuration involves the use of an upper and lower casting. A third option incorporates four castings, both left and right, top and bottom.

Many independent builders choose the first option, preferring to bypass the casting process and mill all of their housing components from commercially available stock. Another important element associated with the casing is the inlet nozzle through which the propelling fluid is introduced. If reversibility is desired, a second nozzle can be installed for the introduction of

fluid in the opposite direction. Using compressed air or even steam to operate such a motor as described here is fairly straight forward. All that is needed is a compressor or a conventional boiler as the source of pressurized fluid. If, however, this motor is to be run on gasoline or some other explosive fuel it needs an accessory apparatus or fluid pressure generator into which the fuel and air are injected, to mix and then be ignited. The products of combustion that are developed, along with steam, if water is also injected, are then directed through a nozzle into the rotor housing.

Such pressure generating appliances that are used in conjunction with upstream compressor stages already exist. In them an ignited fuel air mixture is continuously burned to provide a nearly uniform flame front. Another important creation of Nikola Tesla's, called the valvular conduit, simplifies the design even further by reducing the need for a compressor while also making possible the introduction of a modified combustion regime. When incorporated at the combustion chamber inlets the valvular action of this device makes the turbine more like an internal combustion engine. While introduction of fuel and air proceeds as usual, immediately upon the point of ignition all of the inlets are effectively closed. This is due to the action of the valvular conduit which, without moving parts, has the singular property of permitting free flow to occur in one direction only.

After the hot gases enter into the turbine, natural venting working in combination with an optional compressor or downstream ventilator clears the combustion chamber and promotes the introduction of another charge. In such a manner successive explosions of the fuel air mixture occur and are projected through the nozzle. The rapidity of these pulses depends primarily upon the volume of the combustion chamber and the degree of ventilation. In speaking of their frequency Tesla said, "I have been able to speed up the rate of such explosions until the sound of exploding gasses produced a musical note."

What improvements might be made to the basic disk turbine design? Between 1906 and 1927 Tesla made real progress optimizing the engine. Nevertheless, it is reasonable to expect that some further work could have a positive effect on the machine's performance. A first step might be to evaluate the properties of the propelling fluid as it exists while inside the engine casing. In this way the intra-discular spacing might be modified in response to the actual boundary layer depth and physical conditions at and near the disk surfaces. Another possibility lies in working with the number, size and distribution of the rivets and more importantly the ring washer spacers that are positioned between the turbine disks. A third area warranting serious investigation relates to the materials used in construction of the runner subassembly.

It is well known that any increase in the allowable turbine operating temperature results in higher engine efficiency. Turbine engineers have long sought exotic materials out of which to fabricate their turbine blades, the most heat sensitive component. These efforts have resulted in the development of a variety of suitable materials. One of the best that is presently being used is a complex super alloy known as Inconel. Its three principal constituents are: nickel (60%), chromium (16%), and cobalt (8.5%), with lesser amounts of aluminum, titanium,

tungsten, molybdenum, tantalum and cadmium. Inconel has proven capable of sustaining turbine inlet temperatures of 1,832 F. It is interesting to note that some of Tesla's turbine disks were fabricated out of a material known as German Silver. This hard alloy, once commonly used for tableware, also contains nickel along with copper and zinc in varying proportions.

No doubt the super high performance heat engines of the future will be constructed of even more advanced temperature resistant, high strength materials. There are a number of promising possibilities in this regard. One prospect is injection-molded silicon nitride (Si₃N₄) strengthened with silicon carbide (SiC) whiskers. Components formed out of this ceramic composite are processed using a technique known as Hot Isostatic Pressing (HIP).

Another candidate is a metal matrix composite of niobium (Nb) combined with tungsten mesh, or refractory fibers of Nicalon or FP-Al₂O₃ for reinforcement. Components made of niobium matrix composites require an iridium coating for oxidation protection. A third promising contestant that has been identified is a reaction milled composite called AlN dispersoid-reinforced NiAl. This nickel-aluminum alloy based material is produced by milling NiAl powder in liquid nitrogen. While actual performance data are not yet available for the NiAl/AlN composite, tests show that it compares very favorably with other super alloys that are presently being used.

A related material known as single crystal NiAl has already been formed into turbine blades and could be adopted immediately. A near term benefit to be derived from the use of this material, as with the other NiAl compounds, would be a substantial reduction in weight. In this case weight savings in a conventional rotor blade and disk system would be about 40%. Furthermore, it is expected that techniques will be developed to control high temperature deformation of these oxidation resistant materials. This will result in heat engines with further reduced cooling requirements and even higher operating temperatures.

Dr. Tesla's engineering legacy when placed in context with recent developments in the areas of conventional turbine engine design, tooling, materials processing and electronics establishes a secure platform for the development of a radically new type of automobile engine and drive train. By adopting an interdisciplinary approach that incorporates new light weight carbon fiber composite materials, advanced power electronics and microprocessors in combination with hydraulics and our best electric motors we can have a form of personal transportation such as the world has never seen. The vehicles of the twenty-first century promise to be more efficient, economical, durable, better performing and easy on the environment than anything we have on the road today!

compliments: Gary Peterson - 21st Century Books, <http://www.tfcbooks.com> used by permission.

Tesla's Turbine:

WHEN his World Wireless System project crashed, Tesla turned again to a project to which he had given considerable thought at the time he was developing his poly phase alternating-current system: that of developing a rotary engine which would be as far in advance of existing steam engines as his alternating-current system was ahead of the direct-current system, and which could be used for driving his dynamos. All of the steam engines in use in powerhouses at that time were of the reciprocating type; essentially the same as those developed by Newcomer and Watt, but larger in size, better in construction and more efficient in operation. Tesla's engine was of a different type--a turbine in which jets of steam injected between a series of disks produced rotary motion at high velocity in the cylinder on which these disks were mounted. The steam entered at the outer edge of the disks, pursued a spiral path of a dozen or more convolutions, and left the engine near the central shaft.

When Tesla informed a friend in 1902 that he was working on an engine project, he declared he would produce an engine so small, simple and powerful that it would be a "powerhouse in a hat." The first model, which he made about 1906, fulfilled this promise. It was small enough to fit into the dome of a derby hat, measured a little more than six inches in its largest dimension, and developed thirty horsepower. The power-producing performance of this little engine vastly exceeded that of every known kind of prime mover in use at that time.

The engine weighed a little less than ten pounds. Its output was therefore three horsepower per pound. The rotor weighed only a pound and a half, and its light weight and high power yield gave Tesla a slogan which he used on his letterheads and envelopes--"Twenty horsepower per pound." There was nothing new, of course, in the basic idea of obtaining circular motion directly from a stream of moving fluid. Windmills and water wheels, devices as old as history, performed this feat. Hero, the Alexandrian writer, about 200 bc, described, but he did not invent, the first turbine. It consisted of a hollow sphere of metal mounted on an axle, with two tubes sticking out of the sphere at a tangent to its surface. When water was placed in the sphere and the device was suspended in a fire, the reaction of the steam coming out of the tubes caused the device to rotate.

Tesla's ingenious and original development of the turbine idea probably had its origin in that amusing and unsuccessful experiment he made when, as a boy, he tried to build a vacuum motor and observed its wooden cylinder turn slightly by the drag of the air leaking into the vacuum chamber. Later, too, when as a youth he fled to the mountains to escape military service and played with the idea of transporting mail across the ocean through an underwater tube, through which a hollow sphere was to be carried by a rapidly moving stream of water, he had discovered that the friction of the water on the walls of the tube made the idea impracticable. The friction would slow down the velocity of the stream of water so that excessive amounts of power would be required to move the water at a desired speed and pressure. Conversely, if the water moved at this speed, the friction caused it to try to drag the enclosing tube along with it.

It was this friction which Tesla now utilized in his turbine. A jet of steam rushing at high velocity between disks with a very small distance separating them was slowed down by the friction--but the disks, being capable of rotation, moved with increasing velocity until it was almost equal to that of the steam. In addition to the friction factor, there exists a peculiar attraction between gases and metal surfaces; and this made it possible for the moving steam to grip the metal of the disks more effectively and drag them around at high velocities. The first model which Tesla made in 1906 had twelve disks five inches in diameter. It was operated by compressed air, instead of steam, and attained a speed of 20,000 revolutions per minute. It was Tesla's intention eventually to use oil as fuel, burning it in a nozzle and taking advantage of the tremendous increase in volume, in the change from a liquid to burned highly expanded gases, to turn the rotor. This would eliminate the use of boilers for generating steam and give the direct process proportional increased efficiency.

Had Tesla proceeded with the development of his turbine in 1889 when he returned from the Westinghouse plant, his turbine might perhaps have been the one eventually developed to replace the slow, big, lumbering reciprocating engines then in use. The fifteen years, however, which he devoted to the development of currents of high potential and high frequency, had entailed a delay which gave opportunity for developers of other turbine ideas to advance their work to a stage which now was effective in putting Tesla in the status of a very late starter. In the meantime, turbines had been developed which were virtually windmills in a box. They consisted of rotors with small buckets or vanes around the circumference which were struck by the incoming steam jet. They lacked the simplicity of the Tesla turbine; but by the time Tesla introduced his type, the others were well entrenched in the development stage. Tesla's first tiny motor was built in 1906 by Julius C. Czito, who operated at Astoria, Long Island, a machine shop for making inventor's models. He also built the subsequent 1911 and 1925 models of the turbine, and many other devices on which Tesla worked up to 1929. Mr. Czito's father had been a member of Tesla's staff in the Houston Street laboratories, from 1892 to 1899, and at Colorado Springs.

Mr. Czito's description of the first model is as follows: "The rotor consisted of a stack of very thin disks six inches in diameter, made of German silver. The disks were one thirty-second of an inch thick and were separated by spacers of the same metal and same thickness but of much smaller diameter which were cut in the form of a cross with a circular center section. The extended arms served as ribs to brace the disks...There were eight disks and the edgewise face of the stack was only one-half inch across. They were mounted on the center of a shaft about six inches long. The shaft was nearly an inch in diameter in the mid section and was tapered in steps to less than half an inch at the ends. The rotor was set in a casing made in four parts bolted together.

The circular chamber where the rotor turned was accurately machined to allow a clearance of one sixty-fourth of an inch between the casing and the face of the rotor. Mr. Tesla desired an almost touching fit between the rotor face and the casing when the latter was turning. The large clearance was necessary because the rotor attained tremendously high speeds,

averaging 35,000 revolutions per minute. At this speed the centrifugal force generated by the turning movement was so great it appreciably stretched the metal in the rotating disks. Their diameter when turning at top speed was one thirty-second of an inch greater than when they were standing still." A larger model was built by Tesla in 1910. It had disks twelve inches in diameter, and with a speed of 10,000 revolutions per minute it developed 100 horsepower, indicating a greatly improved efficiency over the first model. It developed more than three times as much power at half the speed. During the following year, 1911, still further improvements were made. The disks were reduced to a diameter of 9.75 inches and the speed of operation was cut down by ten per cent, to 9,000 revolutions per minute--and the power output increased by ten per cent, to 110 horsepower!

Following this test, Tesla issued a statement in which he declared: I have developed 110 horsepower with disks nine and three quarter inches in diameter and making a thickness of about two inches. Under proper conditions the performance might have been as much as 1,000 horsepower. In fact there is almost no limit to the mechanical performance of such a machine. This engine will work with gas, as in the usual type of explosion engine used in automobiles and airplanes, even better than it did with steam. Tests which I have conducted have shown that the rotary effort with gas is greater than with steam. Enthusiastic over the success of his smaller models of the turbine, operated on compressed air, and to a more limited extent by direct combustion of gasoline, Tesla designed and built a larger, double unit, which he planned to test with steam in the Waterside Station, the main powerhouse of the New York Edison Company.

This was a station which had originally been designed to operate on the direct-current system developed by Edison--but it was now operating throughout on Tesla's poly phase alternating-current system. Now Tesla, invading the Edison sanctum to test a new type of turbine which he hoped would replace the types in use, was definitely in enemy territory. The fact that he had Morgan backing, and that the Edison Company was a ``Morgan company," had no nullifying effect on the Edison-Tesla feud. This situation was not softened in any way by Tesla's method of carrying on his tests. Tesla was a confirmed "sun dodger"; he preferred to work at night rather than in the daytime.

Powerhouses, not from choice but from necessity, have their heaviest demands for current after sunset. The day load would be relatively light; but as darkness approached, the dynamos started to groan under the increasing night load. The services of the workers at the Waterside Station were made available to Tesla for the setting up and tests of his turbine with the expectation that the work would be done during the day when the tasks of the workers were easiest. Tesla, however, would rarely show up until five o'clock in the afternoon, or later, and would turn a deaf ear to the pleas of workers that he arrive earlier. He insisted that certain of the workers whom he favored remain after their five-o'clock quitting time on the day shift to work with him on an overtime basis. Nor did he maintain a conciliatory attitude toward the engineering staff or the officials of the company. The attitudes, naturally, were mutual.

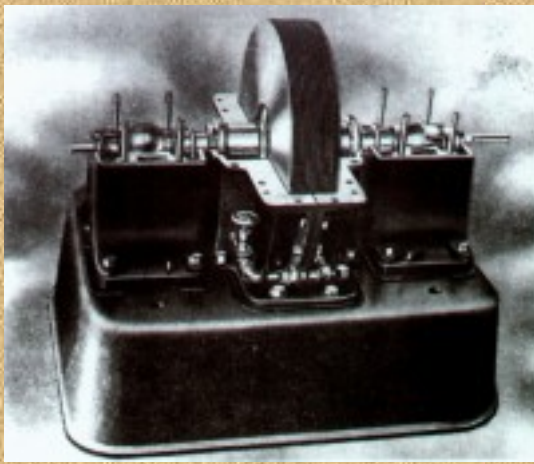

The turbine Tesla built for this test had a rotor 18 inches in diameter which turned at a speed of 9,000 revolutions per minute. It developed 200 horsepower. The overall dimensions of the engine were--three feet long, two feet wide and two feet high. It weighed 400 pounds. Two such turbines were built and installed in a line on a single base. The shafts of both were connected to a torque rod. Steam was fed to both engines so that, if they were free to rotate, they would turn in opposite directions. The power developed was measured by the torque rod connected to the two opposing shafts. At a formal test, to which Tesla invited a great many guests, he

issued a statement in which he said, as reported, in part:

"It should be noted that although the experimental plant develops 200 horsepower with 125 pounds at the supply pipe and free exhaust it could show an output of 300 horsepower with full pressure of the supply circuit. If the turbine were compounded and the exhaust were led to a low pressure unit carrying about three times the number of disks contained in the high pressure element, with connection to a condenser affording 28.5 to 29.0 inches of vacuum the results obtained in the present high pressure machine indicate that the compounded unit would give an output of 600 horsepower without great increase of dimensions. This estimate is very conservative."

Tests have shown that when the turbine is running at 9,000 revolutions per minute under an inlet pressure of 125 pounds to the square inch and with free exhaust 200 brake horsepower are developed. The consumption under these conditions of maximum output is 38 pounds of saturated steam per horsepower per hour, a very high efficiency when we consider that the heat drop, measured by thermometers, is only 130 B.T.U. and that the energy transformation is effected in one stage. Since three times the number of heat units are available in a modern plant with superheat and high vacuum the utilization of these facilities would mean a consumption of less than 12 pounds per horsepower hour in such turbines adapted to take the full drop.

Under certain conditions very high thermal efficiencies have been obtained which demonstrate that in large machines based on this principle steam consumption will be much lower and should approximate the theoretical minimum thus resulting in the nearly frictionless turbine transmitting almost the entire expansive energy of the steam to the shaft. It should be kept in mind that all of the turbines which Tesla built and tested were single-stage engines, using about one-third of the energy of the steam. In practical use, they were intended to be installed with a second stage which would employ the remaining energy and increase the power output about two or three fold. (The two types of turbines in common use each have a dozen and more stages within a single shell.)

Some of the Edison electric camp, observing the torque-rod tests and apparently not

understanding that in such a test the two rotors remain stationary--their opposed pressures staging a tug of war measured as torque--circulated the story that the turbine was a complete failure; that this turbine would not be practical if its efficiency had been increased a thousand fold. It was stories such as these that contributed to the imputation that Tesla was an impractical visionary. The Tesla turbine, however, used as a single-stage engine, functioning as a pygmy power producer, in the form in which it was actually tested, anticipated by more than twenty five years a type of turbine which has been installed in recent years in the Waterside Station. This is a very small engine, with blades on its rotor, known as a "topping turbine," which is inserted in the steam line between the boilers and the ordinary turbines. Steam of increased pressure is supplied, and the topping turbine skims this "cream" from the steam and exhausts steam that runs the other turbines in their normal way. The General Electric Company was developing the Curtis turbine at that time, and the Westinghouse Electric and Manufacturing Company was developing the Parsons turbine; and neither company showed the slightest interest in Tesla's demonstration.

Further development of his turbine on a larger scale would have required a large amount of money--and Tesla did not possess even a small amount. Finally he succeeded in interesting the Allis Chalmers Manufacturing Company of Milwaukee, builders of reciprocating engines and turbines, and other heavy machinery. In typical Tesla fashion, though, he manifested in his negotiations such a lack of diplomacy and insight into human nature that he would have been better off if he had completely failed to make any arrangements for exploiting the turbine.

Tesla, an engineer, ignored the engineers on the Allis Chalmers staff and went directly to the president. While an engineering report was being prepared on his proposal, he went to the Board of Directors and "sold" that body on his project before the engineers had a chance to be heard. Three turbines were built. Two of them had twenty disks eighteen inches in diameter and were tested with steam at eighty pounds pressure. They developed at speeds of 12,000 and 10,000 revolutions per minute, respectively, 200 horsepower. This was exactly the same power output as had been achieved by Tesla's 1911 model, which had disks of half this diameter and was operated at 9,000 revolutions under 125 pounds pressure. A much larger engine was tackled next. It had fifteen disks sixty inches in diameter, was designed to operate at 3,600 revolutions per minute, and was rated at 500 kilowatts capacity, or about 675 horsepower. Hans Dahlstrand, Consulting Engineer of the Steam Turbine Department, reports, in part:

We also built a 500 kw steam turbine to operate at 3,600 revolutions. The turbine rotor consisted of fifteen disks 60 inches in diameter and one eighth inch thick. The disks were placed approximately one eighth inch apart. The unit was tested by connecting to a generator. The maximum mechanical efficiency obtained on this unit was approximately 38 per cent when operating at steam pressure of approximately 80 pounds absolute and a back pressure of approximately 3 pounds absolute and 100 degrees F superheat at the inlet. When the steam pressure was increased above that given the mechanical efficiency dropped, consequently the design of these turbines was of such a nature that in order to obtain maximum efficiency at

high pressure, it would have been necessary to have more than one turbine in series.

The efficiency of the small turbine units compares with the efficiency obtainable on small impulse turbines running at speeds where they can be directly connected to pumps and other machinery. It is obvious, therefore, that the small unit in order to obtain the same efficiency had to operate at from 10,000 to 12,000 revolutions and it would have been necessary to provide reduction gears between the steam turbine and the driven unit. Furthermore, the design of the Tesla turbine could not compete as far as manufacturing costs with the smaller type of impulse units. It is also questionable whether the rotor disks, because of light construction and high stress, would have lasted any length of time if operating continuously. The above remarks apply equally to the large turbine running at 3,600 revolutions. It was found when this unit was dismantled that the disks had distorted to a great extent and the opinion was that these disks would ultimately have failed if the unit had been operated for any length of time.

The gas turbine was never constructed for the reason that the company was unable to obtain sufficient engineering information from Mr. Tesla indicating even an approximate design that he had in mind. Tesla appears to have walked out on the tests at this stage. In Milwaukee, however, there was no George Westinghouse to save the situation. Later, during the twenties, the author asked Tesla why he had terminated his work with the Allis Chalmers Company. He replied: "They would not build the turbines as I wished"; and he would not amplify the statement further. The Allis Chalmers Company later became the pioneer manufacturers of another type of gas turbine that has been in successful operation for years.

While the Dahlstrand report may appear to be severely critical of the Tesla turbine and to reveal fundamental weaknesses in it not found in other turbines, such is not the case. The report is, in general, a fair presentation of the results; and the description of apparent weaknesses merely offers from another viewpoint the facts which Tesla himself stated about the turbine in his earlier test--that when employed as a single-stage engine it uses only about a third of the energy of the steam, and that to utilize the remainder, it would have to be compounded with a second turbine. The reference to a centrifugal force of 70,000 pounds resulting from the high speed of rotation of the rotor, causing damage to the disks, refers to a common experience with all types of turbines. This is made clear in a booklet on "The Story of the Turbine," issued during the past year by the General Electric Company, in which it is stated: It [the turbine] had to wait until engineers and scientists could develop materials to withstand these pressures and speeds. For example, a single bucket in a modern turbine traveling at 600 miles per hour has a centrifugal force of 90,000 pounds trying to pull it from its attachment on the bucket wheel and shaft. . . .

In this raging inferno the high pressure buckets at one end of the turbine run red hot while a few feet away the large buckets in the last stages run at 600 miles per hour through a storm of tepid rain--so fast that the drops of condensed steam cut like a sand blast. Dahlstrand reported that difficulties were encountered in the Tesla turbine from vibration, making it necessary to re-enforce the disks. That this difficulty is common to all turbines is further indicated by the

General Electric booklet, which states:

Vibration cracked buckets and wheels and wrecked turbines, sometimes within a few hours and sometimes after years of operation. This vibration was caused by taking such terrific amounts of power from relatively light machinery--it some cases as much as 400 horsepower out of a bucket weighing but a pound or two. . . .

The major problems of the turbine are four--high temperatures, high pressures, high speeds and internal vibration. And their solution lies in engineering, research and manufacturing skill. These problems are still awaiting their final solution, even with the manufacturers who have been building turbines for forty years; and the fact that they were encountered in the Tesla turbine, and so reported, is not a final criticism of Tesla's invention in the earliest stages of its development.

The development of new alloys, which can now almost be made to order with desired qualities of mechanical stability under conditions of high temperature and great stresses, is largely responsible for this turn of events. It is a possibility that if the Tesla turbine were constructed with the benefit of two or more stages, thus giving it the full operating range of either the Curtis or the Parsons turbine, and were built with the same benefits of engineering skill and modern metallurgical developments as have been lavished on these two turbines, the vastly greater simplicity of the Tesla turbine would enable it to manifest greater efficiencies of operation and economies of construction.

BOUNDARY-LAYER BREAKTHROUGH

THE TESLA BLADELESS DISK TURBINE

INTRODUCTION:

Most people remember Nikola Tesla for his work and revelations in the field of electrical energy and the invention of radio. However, Tesla had a life long interest in developing a flying machine. Tesla had envisioned himself as the first man that would fly. He had planned to build an aircraft that would operate on electric motors. However, the first men who successfully flew an aircraft used the reciprocating internal combustion engine. Though successful in achieving flight, aircraft using these engines were dangerous and unpredictable, due to the engine's lack of adequate power. Tesla turned his attention to revamping the internal combustion engine so as to make flying

safe for all and minimize its environmental impact. Documented in this text is the result of Tesla's endeavors and the resulting marvel of machines called the Bladeless Boundary- Layer Turbine.

Although Tesla's dream for his engines application in aircraft was not realized in his life time, if allowed to be used in aircraft today, it would provide a quiet, safe, simple and efficient alternative to our supposedly advanced bladed turbine aircraft engines. It has been estimated that an increase in fuel efficiency of a factor of three could be realized in aircraft and thus substantially reduce pollution. Not only this, the Bladeless Tesla Turbine Engine can turn at much higher speeds with total safety. If a conventional bladed turbine engine goes critical or fails, watch out, you have exploding parts slicing through hydraulic lines, control surfaces and maybe even you. With the Bladeless Tesla Turbine this is not a danger because it will not explode. If it does go critical, as has been documented in tests at 85,000 rpm, the failed component will not explode but implode into tiny pieces which are ejected through the exhaust while the undamaged components continue to provide thrust to keep you airborne. We can only speculate on the human suffering that could and should be averted.

The application of this amazing engine was not to be limited to aircraft. Tesla was setting up plans to replace what he considered the wasteful, polluting, inefficient and complicated reciprocating engine in all its applications, including the automobile. Tesla's small but powerful engine has only one moving part and is 95% efficient, which means tremendous mileage. It runs vibration free and doesn't even require a muffler. Not only is this engine 95% efficient, as compared to 25% efficiency or less of the conventional gas engine, it can run efficiently on any fuel from sawdust to hydrogen with no wear on the internal engine components. This engine's speed-torque characteristic allows full torque at the bottom of the speed range eliminating the conventional shifting gear transmission. This provides additional economy as the expensive, complicated and wear prone transmission is eliminated.

Unlike most people of the time, Tesla was very concerned about the long range environmental damage the reciprocating engines would create. He stressed over and over how we must take the long range view and not step out of harmony with our life support systems. Today the widening concern for Spaceship Earth and the renewal of an old ethic "We don't inherit the Earth from our ancestors, we borrow it from our children" is slowly beginning to awaken people to the concerns of Tesla.

Although the existence of the automobile on city streets dates back to the first years of the century, its role as a contributor to air contamination did not receive wide acceptance among scientists until the 60's. Factual evidence that urban area smog was chemically related to automobile emissions had been produced and acknowledged by scientific groups in the 1950's. Despite vehement disagreement which ensued between government and the automotive industry on this volatile issue, research and development programs were initiated by both groups in an effort to identify the reciprocating internal combustion engine's sources of pollution and determine what corrective action might be taken. Obviously Tesla's ounce of

prevention was not heeded, leaving us with well over the pound required for a cure with nearly half of all air pollution caused by the reciprocating internal combustion engine.

The Boundary Layer Turbine is not only an engine that is hard to comprehend by our currently imposed standards, but can also be used as a pump with slight modification. And like its cousin the engine, it has Herculean power. Unlike conventional pumps that are easily damaged by contaminants, the Bladeless Tesla Pump can handle particles and corrosives in stride as well as gases with no cavitation effect that destroys, in short order, conventional type pumps.

These pumps and engines, though unknown to most, are available for commercial sale. If large scale commercial production was implemented, these engines and pumps would be extremely affordable due to their simplicity of manufacture, longevity, almost total lack of maintenance and the added bonus that they require no crank case oil.

Almost a quarter of the air pollution today comes from the coal being burned to generate electricity. Fuel consumption, resulting in air pollution and acid rain, could be significantly reduced simply by replacing the conventional blade steam turbines currently used by utilities with the Bladeless Tesla Steam Turbine. This also would have the added bonus of drastically reducing maintenance. But the real solution lies in using low temperature wet steam occurring naturally from the ground in the form of geothermal energy. This energy would destroy a conventional bladed steam turbine, unless expensive steam drying is employed. However, the Bladeless Tesla Steam Turbine requires no drying and can be connected directly to the geothermal source. It has been estimated that the geothermal potential in just Southern California alone, could power the entire North American Continent with NO POLLUTION! Large oil companies have comprehended the potential of geothermal energy and have purchased many of these large tracks of prime geothermal land.

Due to the revolutionary concepts embodied in this engine, we can easily end the so called energy crisis and dramatically reduce pollution. Even the vested energy interests are beginning to understand that now is the time for change, realizing their future health and wealth is directly linked to that of the environment. You can't hide or buy your way out of a devastated planet. There must also be a move forward for the many misinformed environmentalists who see our future as one of regression from technology instead of its proper usage.

Tesla from his 1919 autobiography, My Inventions: "My alternating system of power transmission came at a psychological moment, as a long-sought answer to pressing industrial questions, and although considerable resistance had to be overcome and opposing interests reconciled, as usual, the commercial introduction could not be long delayed. Now, compare this situation with that confronting my turbine, for example. One should think that so simple and beautiful an invention, possessing many features of an ideal motor, should be adopted at once and, undoubtedly, it would under similar conditions. But the prospective effect of the rotating

field was not to render worthless existing machinery; on the contrary, it was to give it additional value. The system lent itself to new enterprise as well as to improvement of the old. My turbine is an advance of a character entirely different. It is a radical departure in the sense that its success would mean the abandonment of the antiquated types of prime movers on which billions of dollars have been spent. Under such circumstances the progress must needs be slow and perhaps the greatest impediment is encountered in the prejudicial opinions created in the minds of experts by organized opposition."

H.G. Wells once said that future history will be a race between education and catastrophe. This book is dedicated to the race for education. Reprinted from: Boundary-Layer Breakthrough - The Tesla Bladeless Turbine pages 114-118.

Scientific American September 30, 1911, page 290

From the Complex to the Simple

A MARKED step was taken in the simplification of prime movers when Watt's cumbersome beam engine, with its ingenious but elaborate parallel motion, gave way to the present standard reciprocating type, with only piston rod, cross head and connecting rod interposed between piston and crank. An even greater advance toward ideal simplicity occurred when, after years of effort by inventors to produce a practical rotary, Parsons brought out his compact, though costly, turbine, in which the energy of the steam is developed on a zig-zag path through multitudinous rows of fixed and moving blades.

And now comes Mr. Tesla with a motor which bids fair to carry the steam engine another long step toward the ideally simple prime mover - a motor in which the fixed and revolving blades of the turbine give place to a set of steel disks of simple and cheap construction. If the flow of steam in spiral curves between the adjoining faces of flat disks is an efficient method of developing the energy of the steam, the prime mover would certainly appear to have been at last reduced to its simplest terms.

The further development of the unique turbine which we describe elsewhere will be followed with close attention by the technical world. The results attained with this small high-pressure unit are certainly flattering, and give reason to believe that the addition of a low pressure turbine and a condenser would make this type of turbine as highly efficient as it is simple and cheap in construction and maintenance.

Scientific American September 30, 1911, page 296

The Rotary Heat Motor Reduced to its Simplest Terms

It will interest the readers of the Scientific American to that Nikola Tesla, whose reputation

must, naturally, stand upon the contribution he made to electrical engineering when the art was yet in its comparative infancy, is by training and choice a mechanical engineer, with a strong leaning to that branch of it which is covered by the term "steam engineering." For several years past he has devoted much of his attention to improvements in thermo-dynamic conversion, and the result of his theories and practical experiments is to be found in an entirely new form of prime movers shown in operation at the waterside station of the New York Edison Company, who kindly placed the facilities of their great plant at his disposal for carrying on experimental work.

By the courtesy of the inventor, we are enabled to publish the accompanying views, representing the testing plant at the Waterside station, which are the first photographs of this interesting motor that have yet been made public. The basic principle which determined Tesla's investigations was the well-known fact that when a fluid (steam, gas or water) is used as a vehicle of energy, the highest possible economy can be obtained only when the changes in velocity and direction of the movement of the fluid are made as gradual and easy as possible. In the present forms of turbines in which the energy is transmitted by pressure, reaction or impact, as in the De Laval, Parsons, and Curtiss types, more or less sudden changes both of speed and direction are involved, with consequent shocks, vibration and destructive eddies. Furthermore, the introduction of pistons, blades, buckets, and intercepting devices of this general class, into the path of the fluid involves much delicate and difficult mechanical construction which adds greatly to the cost both of production and maintenance.

The desiderata in an ideal turbine group themselves under the heads of the theoretical and the mechanical. The theoretically perfect turbine would be one in which the fluid was so controlled from the inlet to the exhaust that its energy was delivered to the driving shaft with the least possible losses due to the mechanical means employed. The mechanically perfect turbine would be one which combined simplicity and cheapness of construction, durability, ease and rapidity of repairs, and a small ratio of weight and space occupied to the power delivered on the shaft. Mr. Tesla maintains that in the turbine which forms the subject of this article, he has carried the steam and gas motor a long step forward toward the maximum attainable efficiency, both theoretical and mechanical. That these claims are well founded is shown by the fact that in the plant at the Edison station, he is securing an output of 200 horse-power from a single-stage steam turbine with atmospheric exhaust, weighing less than 2 pounds per horse-power, which is contained within a space measuring 2 feet by 3 feet, by 2 feet in height, and which accomplishes these results with a thermal fall of only 130 B.T.U., that is, about one-third of the total drop available. Furthermore, considered from the mechanical standpoint, the turbine is astonishingly simple and economical in construction, and by the very nature of its construction, should prove to possess such a durability and freedom from wear and breakdown as to place it, in these respects, far in advance of any type of steam or gas motor of the present day.

Briefly stated, Tesla's steam motor consists of a set of flat steel disks mounted on a shaft and rotating within a casing, the steam entering with high velocity at the periphery of the disks,

flowing between them in free spiral paths, and finally escaping through exhaust ports at their center. Instead of developing the energy of the steam by pressure, reaction, or impact, on a series of blades or vanes, Tesla depends upon the fluid properties of adhesion and viscosity--the attraction of the steam to the faces of the disks and the resistance of its particles to molecular separation combining in transmitting the velocity energy of the motive fluid to the plates and the shaft.

By reference to the accompanying photographs and line drawings, it will be seen that the turbine has a rotor A which in the present case consists of 25 flat steel disks, one thirty-second of an inch in thickness, of hardened and carefully tempered steel. The rotor as assembled is 3 1/2 inches wide on the face, by 18 inches in diameter, and when the turbine is running at its maximum working velocity, the material is never under a tensile stress exceeding 50,000 pounds per square inch. The rotor is mounted in a casing D, which is provided with two inlet nozzles, B for use in running direct and B' for reversing. Openings C are cut out at the central portion of the disks and these communicate directly with exhaust ports formed in the side of the casing.

In operation, the steam, or gas, as the case may be is directed on the periphery of the disks through the nozzle B (which may be diverging, straight or converging), where more or less of its expansive energy is converted into velocity energy. When the machine is at rest, the radial and tangential forces due to the pressure and velocity of the steam cause it to travel in a rather short curved path toward the central exhaust opening, as indicated by the full black line in the accompanying diagram; but as the disks commence to rotate and their speed increases, the steam travels in spiral paths the length of which increases until, as in the case of the present turbine, the particles of the fluid complete a number of turns around the shaft before reaching the exhaust, covering in the meantime a lineal path some 12 to 16 feet in length. During its progress from inlet to exhaust, the velocity and pressure of the steam are reduced until it leaves the exhaust at 1 or 2 pounds gage pressure.

The resistance to the passage of the steam or gas between adjoining plates is approximately proportionate to the square of the relative speed, which is at a maximum toward the center of the disks and is equal to the tangential velocity of the steam. Hence the resistance to radial escape is very great, being furthermore enhanced by the centrifugal force acting outwardly. One of the most desirable elements in a perfected turbine is that of reversibility, and we are all familiar with the many and frequently cumbersome means which have been employed to secure this end. It will be seen that this turbine is admirably adapted for reversing, since this effect can be secured by merely closing the right-hand valve and opening that on the left.

It is evident that the principles of this turbine are equally applicable, by slight modifications of design, for its use as a pump, and we present a photograph of a demonstration model which is in operation in Mr. Tesla's office. This little pump, driven by an electric motor of 1/12 horsepower, delivers 40 gallons per minute against a head of 9 feet. The discharge pipe leads up to a horizontal tube provided with a wire mesh for screening the water and checking the eddies.

The water falls through a slot in the bottom of this tube and after passing below a baffle plate flows in a steady stream about 3/4 inch thick by 18 inches in width, to a trough from which it returns to the pump. Pumps of this character show an efficiency favorably comparing with that of centrifugal pumps and they have the advantage that great heads are obtainable economically in a single stage. The runner is mounted in a two-part volute casing and except for the fact that the place of the buckets, vanes, etc., of the ordinary centrifugal pump is taken by a set of disks, the construction is generally similar to that of pumps of the standard kind.

In conclusion, it should be noted that although the experimental plant at the Waterside station develops 200 horse-power with 125 pounds at the supply pipe and free exhaust, it could show an output of 300 horse-power with the full pressure of the Edison supply circuit. Furthermore, Mr. Tesla states that if it were compounded and the exhaust were led to a low pressure unit, carrying about three times the number of disks contained in the high pressure element, with connection to a condenser affording 28 1/2 to 29 inches of vacuum, the results obtained in the present high-pressure machine indicate that the compound unit would give an output of 600 horse-power, without great increase of dimensions. This estimate is conservative.

The testing plant consists of two identical turbines connected by a carefully calibrated torsion spring, the machine to the left being the driving element, the other the brake. In the brake element, the steam is delivered to the blades in a direction opposite to that of the rotation of the disks. Fastened to the shaft of the brake turbine is a hollow pulley provided with two diametrically opposite narrow slots, and an incandescent lamp placed inside close to the rim. As the pulley rotates, two flashes of light pass out of the same, and by means of reflecting mirrors and lenses, they are carried around the plant and fall upon two rotating glass mirrors placed back to back on the shaft of the driving turbine so that the center line of the silver coatings coincides with the axis of the shaft. The mirrors are so set that when there is no torsion on the spring, the light beams produce a luminous spot stationary at the zero of the scale. But as soon as load is put on, the beam is deflected through an angle which indicates directly the torsion. The scale and spring are so proportioned and adjusted that the horse-power can be read directly from the deflections noted. The indications of this device are very accurate and have shown that when the turbine is running at 9,000 revolutions under an inlet pressure of 125 pounds to the square inch, and with free exhaust, 200 brake horse-power are developed. The consumption under these conditions of maximum output is 38 pounds of saturated steam per horse-power per hour - a very high efficiency when we consider that the heat-drop, measured by thermometers, is only 130 B.T.U., and that the energy transformation is effected in one stage. Since about three times this number of heat units are available in a modern plant with super-heat and high vacuum, the above means a consumption of less than 12 pounds per horse-power hour in such turbines adapted to take up the full drop. Under certain conditions, however, very high thermal efficiencies have been obtained which demonstrate that in large machines based on this principle, in which a very small slip can be secured, the steam consumption will be much lower and should, Mr. Tesla states, approximate the theoretical minimum, thus resulting in nearly frictionless turbine transmitting almost the entire expansive energy of the steam to the shaft.

BOUNDARY-LAYER BREAKTHROUGH [3] - THE TESLA BLADELESS TURBINE

Journey back to the future and discover the fascinating secret behind the most powerful and economic internal or external combustion engine of all time: Tesla's Bladeless Boundary-Layer Turbine. You will experience the excitement of understanding as Tesla's mechanical breakthrough is explored, shattering the boundaries of our current mechanical standard. You will be swept into the awareness of discovery as the simplicity of this whirl wind machine of natural harmony is revealed. Unveiled here today how it is possible to convert the normally undesired energy of drag into the tremendous vortex energy of Tesla's perfectly controlled mechanical tornado. The real answer to energy.

The history of Tesla's monarch of machines is then followed into the present day work of researchers and inventors C.R. "Jake" Possell [1]. and Frank Germano (President of International Turbine And Power, LLC)[2]. You will learn how modern day applications of the bladeless turbine could improve all aspects of our mechanical life. Today's applications range from indestructible pumps and Freon free air conditioning to speed boats and supersonic aircraft.

Conventional pumps and engines pale in comparison. This jewel of mechanics has no equal. It stands alone above all others. No other pump or engine can match the longevity, economy, size, safety, silence and vibration free Herculean power of this truly elegant machine. It waits patiently to solve the efficiency and pollution problems of today and could literally usher in A NEW WORLD. Fully Illustrated

[1] Mr. C. R. "Jake" Possell Is President of a Public Company - QUADRATECH, Inc., 1417 South Gage Street, San Bernardino, CA 92408

[2] Mr. Frank Germano is President of a Private Company - International Turbine And Power, LLC, 931 Rumsey Avenue, Cody, Wyoming 82414, and Founder and CEO of Germano Industries, Inc., HC1, Lake Wallenpaupack, PA 18464.

[3] BOUNDARY-LAYER BREAKTHROUGH - THE BLADELESS TESLA TURBINE Volume II. The Tesla Technology Series, ISBN 1-882137-01-9

END

Additional Information and Patents:

- [1921 Patent](#)
 - [Fluid Propulsion Patent](#)
 - [Original 1911 Turbine & Pump Patent](#)
 - [Improved Method For the Production of High Vacuum - patent](#)
 - [Researching A Shockwave Tesla Turbine](#)
 - [A Thermo-Pneumatic Tesla Turbine Locomotive](#)
-

The Tesla Turbine "Yahoo Groups" List:

this list has grown substantially since its initial creation in 1999. The list is used to keep members informed of important updates, new ideas on turbine construction, and for a general forum and outlet on new and innovative concepts in the construction of the Tesla Turbine. The list is moderated by founder and creator of International Turbine And Power, LLC - Mr. Frank Germano. There are at any time approximately 1000 interested individuals on this list. If you would like to join this exciting Tesla Turbine List, use the link(s) below and follow the instructions.

● Click below, to subscribe...then follow the instructions. You will receive a confirmation email, from "Yahoo Groups" that you MUST reply to in order to join the group. Use the email address that you wish the confirmation email to be sent to.

Subscribe to [TheTeslaTurbineList](#)

Powered by groups.yahoo.com

Compliments & Acknowledgements: : Gary Peterson, ["Twenty First Century Books"](#)...if you are interested in learning more about the Tesla bladeless boundary disk turbine, or the Tesla Pump, check out Gary's web site. Besides carrying a complete listing of excellent books pertaining to Nikola Tesla (honestly: it's probably THE most comprehensive collection of Nikola Tesla books, articles and information We've ever seen...!), he also has written the book , "The Tesla Bladeless Turbine and Related Turbo Machinery", which goes into great detail and depth, on the turbine/pump itself. The web site definitely is worth the time to check out...it's a pretty large site. Great info !

Three Books I highly recommend:

"TESLA'S ENGINE...A NEW DIMENSION FOR POWER" by Jeffery Hayes...highly recommended!

Tesla's Engine: An New Dimension for Power

Product Type: Book

Authors: Jeffery A. Hayes

Publisher: Tesla Engine Builders Assn

Release Date: August, 1994

List Price: \$19.95

Our Price: **\$19.95**



The Tesla Disc Turbine

by W. M. J. Cairns

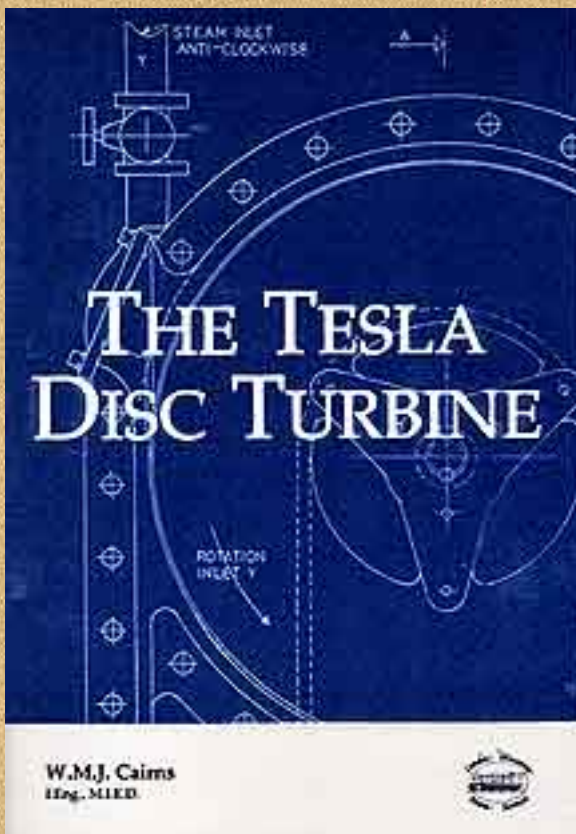

"This book describes the concept of the Disc Turbine as originally patented by Nicola Tesla, and provides concept designs for modern versions of the engine, incorporating the Disc Turbine as a power unit for applications in Automobiles and Light Aircraft, and also give descriptions of the original Turbines and the prototype machines. It also provides designs for other machines operating on the principle of a disc turbine: an Air Compressor, an Air Motor, and a Vacuum Exhauster. The facility of the principle to operate in either a clockwise or anti-clockwise direction of rotation, in a single machine, using only a two-way valve, is described, and applications where this feature can be applied to advantage are suggested.

Data is given on the performances attained by the original engines, together with stress and performance information. Finally, we give a design for a modernized version of the

original turbine, to one half scale, complete with working drawings and manufacturing instructions to enable the model or experimental engineer to construct a fully operational engine, using such tools and equipment as are usually available to model makers.

It should be apparent that this dry foreword written by the author sounds like the abstract of a paper published in a professional engineering journal. That's because the author IS an engineer who has a number of published papers. Cairns is no novice. He knows what he's talking about. Chapters include: Tesla's original machine * The Disc Turbine Operating Principle * The first experimental Turbine * The 9.75 in. Disc Prototype Turbine * Larger Turbines to 60 in. disc diameter * Future developments * Other Rotary Engines * The Automotive Disc Turbine * Air Compressor, Vacuum Pump, Air Motor, Light Aircraft Engines * The Dual Direction Facility * Stresses in the discs and performance calculations * Building a model Disc Turbine * Drawings for a model Disc Turbine* Since this is a 36 page "booklet" each "chapter" is necessarily short. But what you DO get is loaded with valuable information. Remember this is written by an engineer who is interested in getting results. The last nine pages are dedicated to the model with six pages of detailed, dimensioned drawings. The model described is approximately one half the size of the original Tesla unit, but uses present-day materials and techniques... Required machine tools are a lathe, with a 3.5" centre height, ideally with a milling attachment, and circular table, a bench drill, micrometer or vernier, and conventional hand tools (metric dimensions are used)

From the testing section: "Run for no more than two minutes, stop, check the housing temperature. If cool to slightly warm, re-open the valve and continue running. At around 1.75 bar and 1.5 cfm, the turbine will attain a shaft speed of 20,000 R.P.M. At all times ensure a supply of oil to the bearings, and continually monitor the housing temperature. It should be noted that the prototype attained a speed of approximately 50,000 R.P.M. under no-load conditions; hence it is advised that a brake or dynamometer be provided on the shaft."

"THE TESLA BLADELESS TURBINE AND RELATED TURBO MACHINERY" by Gary L. Peterson...
(Awesome!!!) If you have any interest in the Tesla Turbine - get this book !

So...you've read through this page; now what? How about some HELP from YOU?! Click on this link and see exactly HOW I could use your assistance, and some of your "coffee money" for starters.

HELP FRANK GERMANO in making this technology available, commercially.

Frank D Germano, Frank@Germano.com

**Founder and President,
International Turbine And Power**

931 Rumsey Avenue, PO Box 550
Cody, Wyoming 82414

[INDEX TO ENTIRE SITE](#)

NIKOLA TESLA:

[\[Home\]](#)[\[Tesla Technology, Today\]](#)[\[Nikola Tesla\]](#)
[\[The Tesla Engine\]](#)[\[Tesla Tunguska; Free Energy\]](#)
[\[The Tesla Bladeless Boundary Disk Turbine\]](#)
[\[Tesla's "Black Box"\]](#)[\[Greatest Hack of All Time?\]](#)
[\[the Lost Tesla Inventions\]](#)[\[A Machine To End War\]](#)
[\[the Wonderworld to be Created by Electricity\]](#)

[\[the Telsa & Schauberger Bookstore \]](#)

VIKTOR SCHAUBERGER:

[\[Water Power - Vortex Theories-\]](#)[\[Water Power II\]](#)
[\[Viktor Schauberger -1-\]](#)[\[Viktor Schauberger -2-\]](#)[\[Viktor Schauberger -3-\]](#)[\[Viktor Schauberger -4-\]](#)

[\[Christian Links\]](#)



Tesla's "new" Turbine runner design (@1921)

This is the design we incorporate into our Turbines.

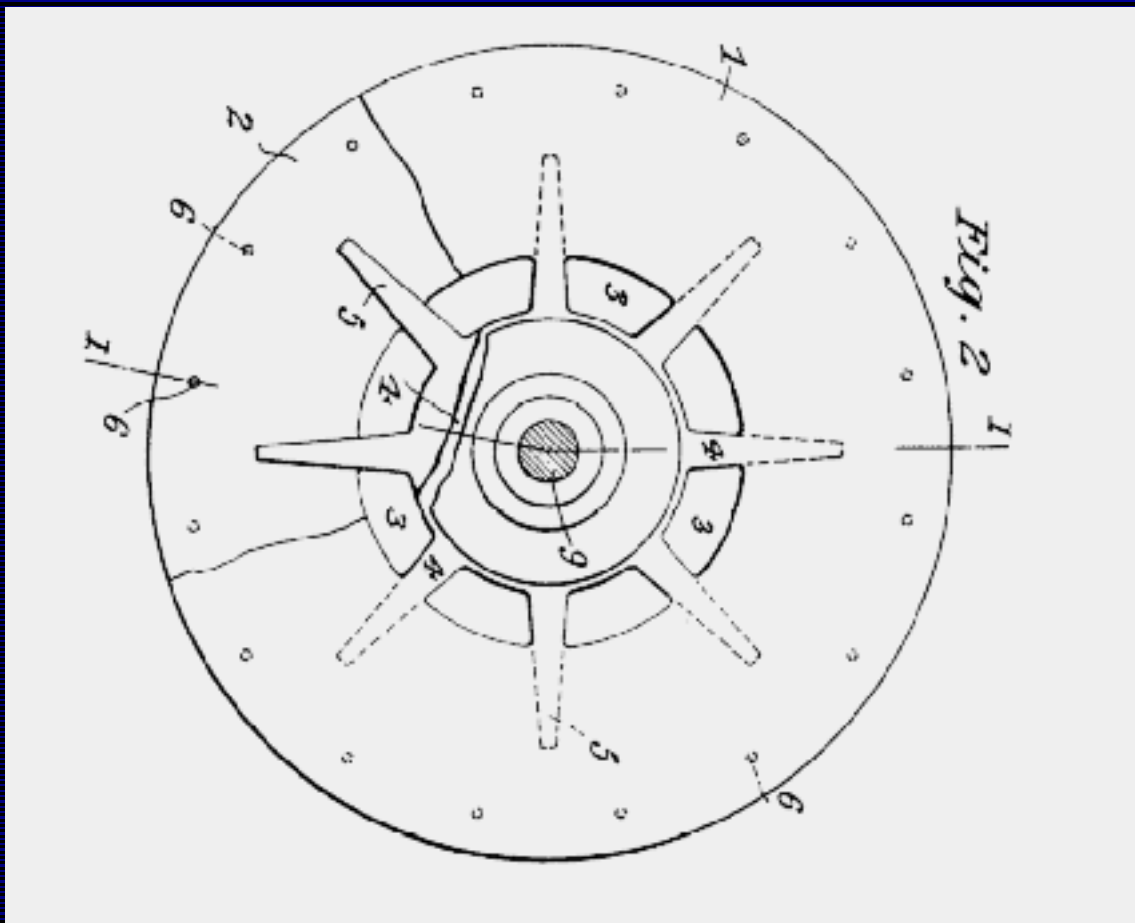
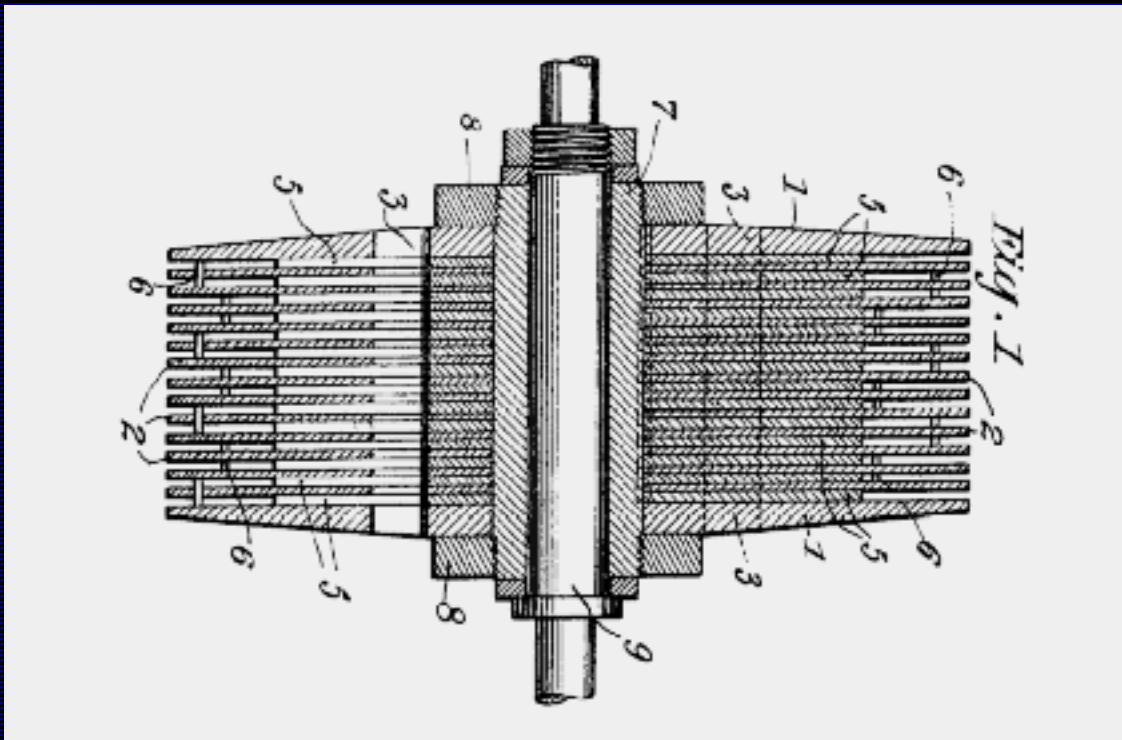

Application Date: Mar 24, 1921 No. 9097

PROVISIONAL SPECIFICATION

Improvements in the Construction of Steam and gas Turbines.

I, Nikola Tesla, Mechanical and Electrical Engineer, citizen of the United States of America, of 8, West 40th Street, New York City, U.S.A., do hereby declare the nature of this invention to be as follows:

In a British Paten, Number 24,001 of 1910, I have described a bladeless turbine having a rotor consisting of discs with openings in the central portions and separating star-washers, these parts when assembled being riveted together into a single, solid structure and keyed to the shaft. This form of rotor operates satisfactorily but in long experience certain improvements in its construction have been found desirable and these constitute my present invention.

In the new design I employ two heavier end-plates, which are machined tapering toward the periphery for the purpose of reducing the maximum centrifugal stress as much as practicable. The inside discs, of relatively thin material, are rolled, forged or ground tapering in like manner and with the same object in view, but this may not always be necessary and plates, made of sheet metal of substantially uniform thickness as furnished by the mills, can be employed. Each of the thick as well as then plates is provided with exhaust openings, leaving a solid central portion like the hub and spokes of a wheel. Star-washers of similar configuration serve the purpose of keeping the discs apart in the center and for the peripheral spacing the thin plates have small holes drilled in them on a circle, or circles, of suitable diameter, and in these are driven tight-fitting studs which are upset at both ends by a special tool so that they will project beyond the metal on each side a trifle more than the thickness of the star-washers. When the plates are put together the separating studs do not come in line but are straddled in order to give opportunity for slight yielding, thereby eliminating constructional difficulties which might be caused by un-evenness or other mechanical imperfections. Thus the rotor can be finished closely to pre-determined overall dimensions and will run true on the outside even if the thin inside plates should vary a little in thickness or be slightly warped. To simplify this arrangement I provide only every second plate with studs, using plain ones between. Furthermore, with the object of cheapening the manufacture I dispense altogether with the former, accomplishing the spacing by means of small bosses or protuberances which are raised in the plates by blows or pressure and provide a die, practically reducing all the machine work on a thin plate to a single operation in a stamping press. The star-washers, while preferable, are not indispensable and may be replaced by round separating washers of a diameter about equal to that of the hub part of the discs.

All the plates and washers are fitted on and keyed to a sleeve threaded at the ends and equipped with nuts and collars for drawing the thick end-plates together or, if desired, the collars may be simply forced onto it and the ends upset. The sleeve has a hole fitting snugly on the shaft and is fastened to the same as usual.

This construction permits free expansion and contraction of each plate individually under the varying influence of heat and centrifugal force and possesses a number of other advantages which are of considerable practical moment. A larger active plate area and consequently more power is obtained for

a given width, this improving efficiency. Warping is virtually eliminated and smaller side clearances may be used which results in diminished leakage and friction losses.

The rotor is better adapted for dynamic balancing and through rubbing friction resists disturbing influences thereby insuring quieter running. For this reason and also because the discs are not rigidly joined it is safer against damage which might otherwise be caused by vibration or excessive speed.

Dated this 24th day of March, 1921. NIKOLA TESLA

COMPLETE SPECIFICATION

Improvements in the Construction of Steam and Gas Turbines

I, Nikola Tesla, Electrical and Mechanical Engineer, citizen of the United States of America of No. 8, West 40th Street, New York NY., U.S.A., do hereby declare the nature of this invention and in what manner the same is to be performed, to be particularly described and ascertained in and by the following statement:

In a British Patent, No. 24,001 of 1910, I have described a bladeless turbine having a rotor consisting of discs with openings in the central portions, and separating star-washers, these parts when assembled being riveted together into a single solid structure and keyed to the shaft. This form of rotor operates satisfactorily but in long experience certain improvements in its construction have been found desirable and these constitute my present invention.

In the new design, illustrated in the accompanying drawings Fig. 1 and Fig. 2, respectively showing a section through the rotor on line II and a side view partly broken away exposing a portion of a star-washer, I preferably employ two heavier end-plates 1, of suitable material made tapering on the outside toward the periphery, as shown, for the purpose of reducing the maximum centrifugal stress as much as practicable. The inside discs 2, are relatively thin and may be tapered on both sides in the peripheral part beyond the star-washers with the same object in view, but plates of substantially uniform thickness, as furnished by the mills, can also be employed. Each of the plates -- thick and well as thin -- is provided with exhaust openings 3, . . . leaving a solid central portion 4, . . . like the hub and spokes of a wheel. If there is an odd number of thin plates the central one may be plain, if desired. Star washers 5, . . . of similar configuration, and projecting with their arms considerably beyond the exhaust openings, serve the purpose of keeping the discs apart in the central region and for the peripheral spacing the thin plates have small holes drilled in them preferably on a circle, or circles, of suitable diameter, and in these are driven tight-fitting spacers or studs 6, . . . which may be upset at the ends so that they will project on each side a trifle more than the thickness of the star-washers 5, When the plates are put together the separating studs do not come in line, but are straddled, as indicated in Fig. 1 and in the broken away part of Fig. 2 by the plain and dotted small circles, in order to give opportunity for slight yielding, thereby eliminating constructional difficulties which might be caused by unevenness or other mechanical imperfections. Such a rotor can be finished closely to predetermined overall dimensions and will run true on the outside, even if the thin inside plates should

vary a little in thickness or be slightly warped. To simplify the construction I provide only every second plate with studs, using plain ones between. Furthermore, with the object of cheapening the manufacture, I may dispense with the studs altogether, accomplishing the peripheral spacing by means of other spacers such as small bosses or protuberances raised in the plates, thus reducing the machine work on the thin ones to a single operation in a stamping press. The star-washers, while preferable, are not indispensable and may be replaced by round separating washers of a diameter about equal to that of the part of the disks.

All the plates and washers are fitted on and keyed to a sleeve 7, threaded at the ends and equipped with nuts 8, for drawing the thick end-plates together or, if desired, the nuts and the threads on the sleeve may be omitted, collars forced on its ends and the same upset. The sleeve fits snugly on the shaft 9 and is fastened to it as usual.

This construction enables the use of thinner inside plates than practicable in the earlier form, thus affording greater active surface and increasing correspondingly the output, while the smaller clearances are instrumental in reducing the leakage losses.

Having now particularly described and ascertained the nature of my said invention, and in what manner the same is to be performed, I declare that what I claim is...

dated the 23 day of august, 1921.

Nikola Tesla

[INDEX]



UNITED STATES PATENT OFFICE

NIKOLA TESLA, OF NEW YORK, N.Y.

1,061,206.

Specification of Letters Patent.

Patented May 6, 1913.

Original application filed October 21, 1909, Serial No. 523,332. Divided and this application filed January 17, 1911. Serial No. 603,049,

To all whom it may concern:

Be it know that I, Nikola Tesla, a citizen of the United States, residing at New York, in the county and State of New York, have invented certain new and useful Improvements in Rotary Engines and Turbines, of which the following is a full, clear, and exact description.

In the practical application of mechanical power, based on the use of fluid as the vehicle of energy, it has been demonstrated that, in order to attain the highest economy, the changes in the velocity and direction of movement of the fluid should be as gradual as possible. In the forms of apparatus heretofore devised or proposed, more or less sudden changes, shocks, and vibration are unavoidable. Besides, the employment of the usual deices for imparting to, or deriving energy from a fluid, such as pistons, paddles, vanes, and blades, necessarily introduces numerous defects and limitations and adds to the complication, cost of production and maintenance of the machines.

The object of my invention is to overcome these deficiencies and to effect the transmission and transformation of mechanical energy through the agency of fluids in a more perfect manner and by means simpler and more economical than those heretofore employed. I accomplish this by causing the propelling fluid to move in natural paths or stream lines of least resistance, free from constraint and disturbance such as occaisioned by vanes or kindred devices, and to change its velocity and direction of movement by impercetible degrees, thus avoiding the losses due to sudden variation while the fluid is imparting energy.

It is well known that a fluid possesses, among others, two salient properties, adhesion and viscosity. Owing to these a solid body propelled through such a medium encounters a peculiar impediment known as "lateral" or skin resistance, which is twofold, one arising from the shock of the fluid against the asperities of the solid substance, the other from internal forces opposing molecular separation. As an inevitable consequence a certain amount of the fluid is dragged along by the moving body. Conversely,

if the body be placed in a fluid in motion, for the same reasons, it is impelled in the direction of movement. These effects, in themselves, are of daily observation, but I believe that I am the first to apply them in a practical and economical manner in the propulsion of fluids or in their use as motive agents.

In an application filed by me October 21st, 1909, Serial Number 523,832 of which this case is a division, I have illustrated the principles underlying my discovery as embodied in apparatus designed for the propulsion of fluids. The same principles, however, are capable of embodiment also in that field of mechanical engineering which is concerned in the use of fluids as motive agents, for while in certain respects the operations in the latter case are directly opposite to those met with in the propulsion of fluids, and the means employed may differ in some features, the fundamental laws applicable in the two cases are the same. In other words, the operation is reversible, for if water or air under pressure be admitted to the opening constituting the outlet of a pump or blower as described, the runner is set in rotation by reason of the peculiar properties of the fluid which, in its movement through the device, imparts its energy thereto.

The present application, which is a division of that referred to, is specially intended to describe and claim my discovery above set forth, so far as it bears on the use of fluids as motive agents, as distinguished from the applications of the same to the propulsion or compression of fluids.

In the drawings, therefore, I have illustrated only the form of apparatus designed for the thermo-dynamic conversion of energy, a field in which the applications of the principle have the greatest practical value.

Figure 1 is a partial end view, and Fig. 2 a vertical cross-section of a rotary engine or turbine, constructed and adapted to be operated in accordance with the principles of my invention.

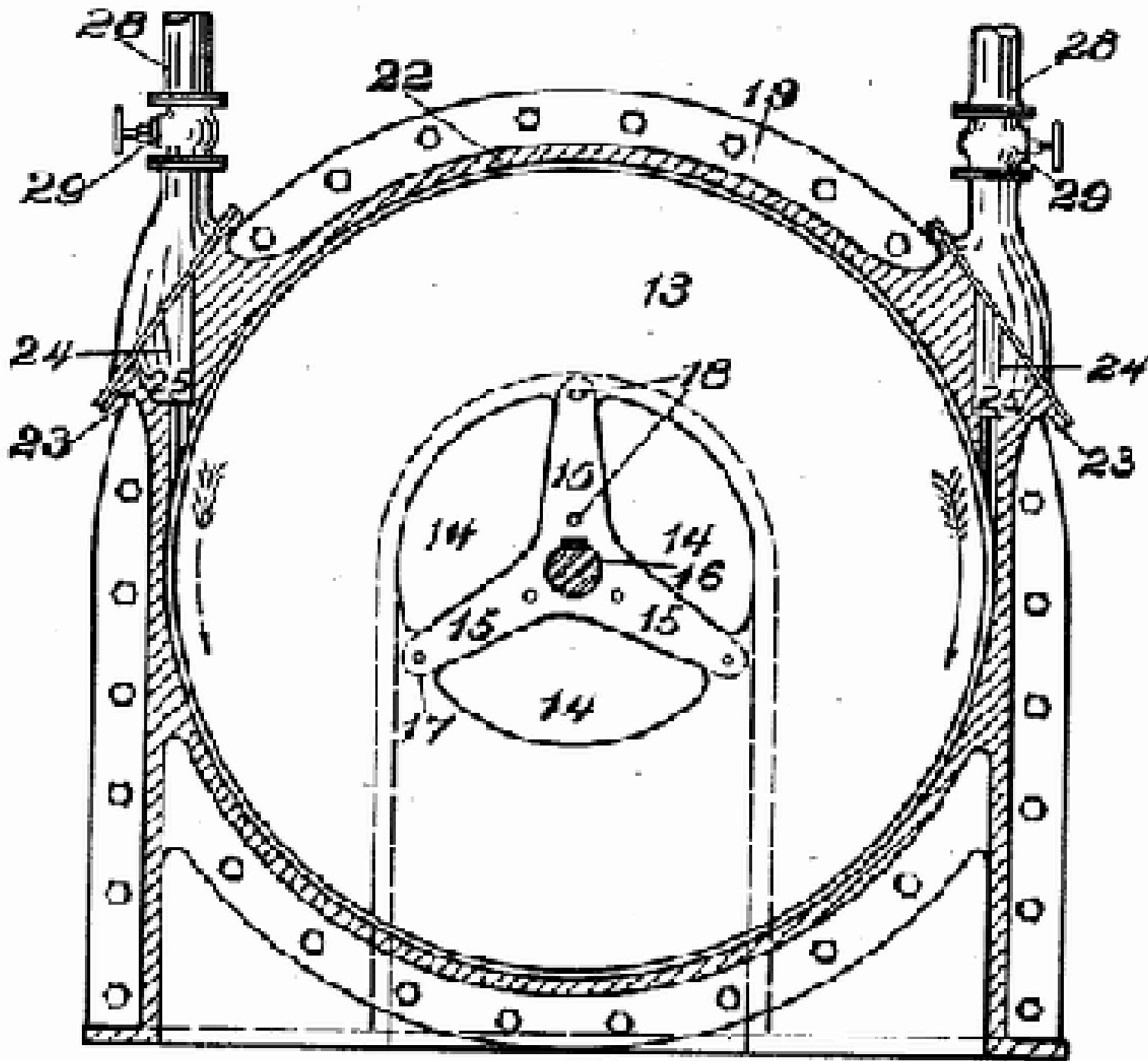

Fig. 1.

The apparatus comprises a runner composed of a plurality of flat rigid disks 13 of suitable diameter, keyed to a shaft 16, and held in position thereon by a threaded nut 11, a shoulder 12, and intermediate washers 17. The disks have openings 14, adjacent to the shaft and spokes 15, which may be substantially straight. For the sake of clearness, but a few disks, with comparatively wide intervening spaces, are illustrated.

The runner is mounted in a casing comprising two end castings 19, which contain the bearings for the

shaft 16, indicated but not shown in detail; stuffing boxes 21 and outlets 20. The end castings are united by a central ring 22, which is bored out to a circle of slightly larger diameter than that of the disks, and has flanged extensions 23, and inlets 24, into which finished ports or nozzles 25 are inserted. Circular grooves 26 and labyrinth packing 27 are provided on the sides of the runner. Supply pipes 28, with valves 29, are connected to the flanged extensions of the central ring, one of the valves being normally closed.

For a more ready and complete understanding of the principle of operation it is of advantage to consider first the actions that take place when the device is used for the propulsion of fluids for which purpose let it be assumed that power is applied to the shaft and the runner set in rotation say in a clockwise direction. Neglecting, for the moment, those features of construction that make for or against the efficiency of the device as a pump, as distinguished from a motor, a fluid, by reason of its properties of adherence and viscosity, upon entering through the inlets 20, and coming in contact with the disks 13, is taken hold of by the latter and subjected to two forces, one acting tangentially in the direction of rotation, and the other radially outward. The combined effect of these tangential and centrifugal forces is to propel the fluid with continuously increasing velocity in a spiral path until it reaches a suitable peripheral outlet from which it is ejected. This spiral movement, free and undisturbed and essentially dependant on the properties of the fluid, permitting it to adjust itself to natural paths or stream lines and to change its velocity and direction by insensible degrees, is a characteristic and essential feature of this principle of operation.

While traversing the chamber inclosing the runner, the particles of the fluid may complete one or more turns, or but a part of one turn, the path followed being capable of close calculation and graphic representation, but fairly accurate estimates of turns can be obtained simply by determining the number of revolutions required to renew the fluid passing through the chamber and multiplying it by the ratio between the mean speed of the fluid and that of the disks. I have found that the quantity of fluid propelled in this manner is, other conditions being equal, approximately proportionate to the active surface of the runner and to its effective speed. For this reason, the performance of such machines augments at an exceedingly high rate with the increase of their size and speed of revolution.

The dimensions of the device as a whole, and the spacing of the disks in any given machine will be determined by the conditions and requirements of special cases. It may be stated that the intervening distance should be the greater, the larger the diameter of the disks, the longer the spiral path of the fluid and the greater its viscosity. In general, the spacing should be such that the entire mass of the fluid, before leaving the runner, is accelerated to a nearly uniform velocity, not much below that of the periphery of the disks under normal working conditions, and almost equal to it when the outlet is closed and the particles move in concentric circles.

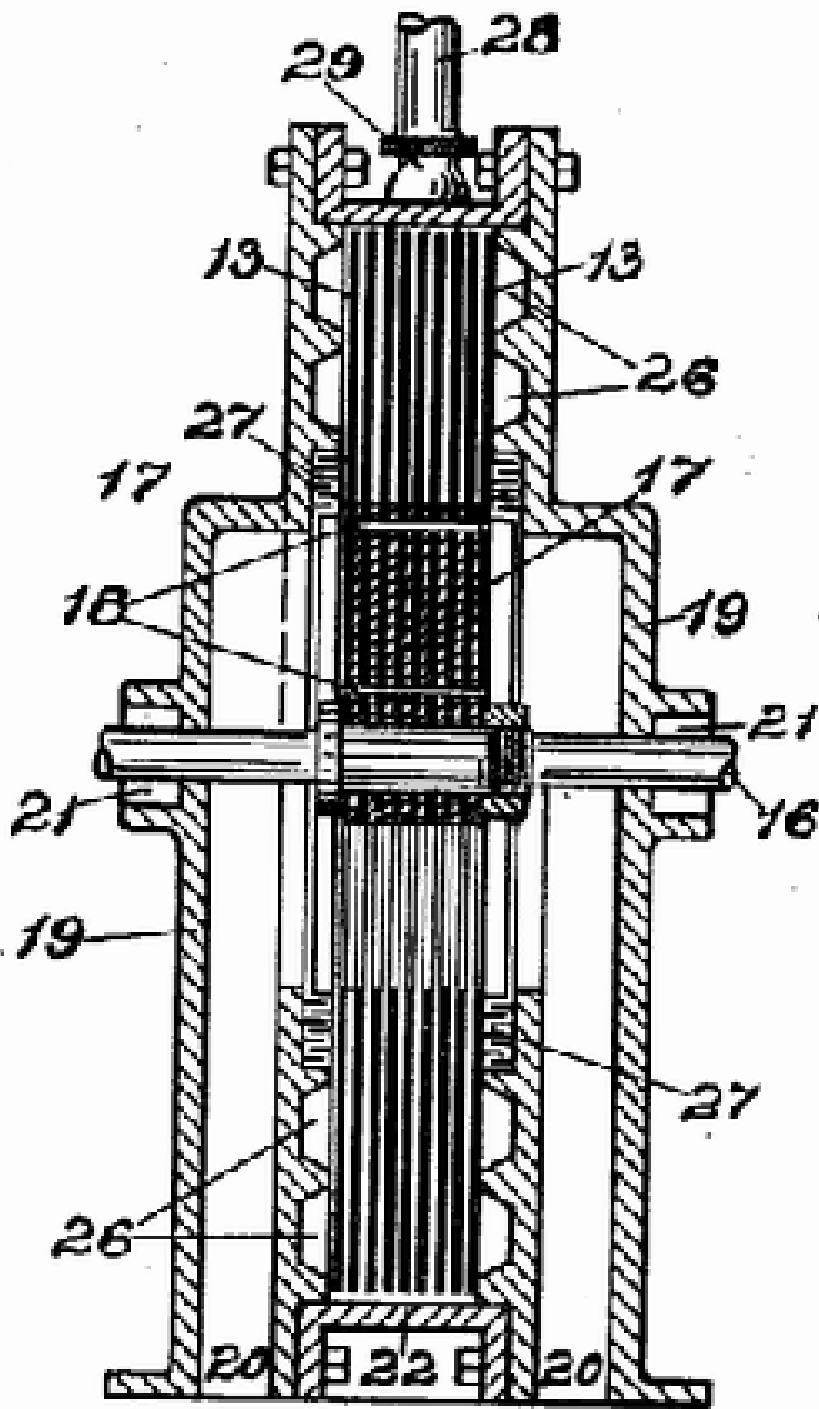

Fig. 2.

area of and reducing the space between the disks.

Considering now the converse of the above described operation and assuming that fluid under pressure be allowed to pass through the valve at the side of the solid arrow, the runner will be set in rotation in a clockwise direction, the fluid traveling in a spiral path and with continuously diminishing velocity until it reaches the orifices 14 and 20, through which it is discharged. If the runner be allowed to turn freely, in nearly frictionless bearings, its rim will attain a speed closely approximating the maximum of that of the adjacent fluid and the spiral path of the particles will be comparatively long, consisting of many almost circular turns. If load is put on and the runner slowed down, the motion of the fluid is retarded, the turns are reduced, and the path is shortened.

Owing to a number of causes affecting the performance, it is difficult to frame a precise rule which would be generally applicable, but it may be stated that within certain limits, and other conditions being the same, the torque is directly proportionate to the square of the velocity of the fluid relatively to the runner, and to the effective area of the disks, and inversely, to the distance separating them. The machine will, generally, perform its maximum work when the effective speed of the runner is one-half that of the fluid; but to attain the highest economy, the relative speed or slip, for any given performance, should be as small as possible. This condition may be to any desired degree approximated by increasing the active

When apparatus of the kind described is employed for the transmission of power certain departures from similarity between transmitter and receiver are necessary for securing the best results. It is evident that when transmitting power from one shaft to another by such machines, any desired ratio between the speeds of rotation may be obtained by a proper selection of the diameters of the disks, or by suitably staging the transmitter, the receiver, or both. But it may be pointed out that in one respect, at least, the

two machines are essentially different. In the pump, the radial or static pressure, due to centrifugal force, is added to the tangential or dynamic, thus increasing the effective head and assisting in the expulsion of the fluid. In the motor, on the contrary, the first named pressure, being opposed to that of supply, reduces the effective head and the velocity of radial flow toward the center. Again, in the propelled machine a great torque is always desirable, this calling for an increased number of disks and smaller distance of separation, while in the propelling machine, for numerous economic reasons, the rotary effort should be the smallest and the speed the greatest practicable. Many other considerations, which will naturally suggest themselves, may affect the design and construction, but the preceding is thought to contain all necessary information in this regard.

In order to bring out a distinctive feature, assume, in the first place, that the motive medium is admitted to the disk chamber through a port, that is a channel which it traverses with nearly uniform velocity. In this case, the machine will operate as a rotary engine, the fluid continuously expanding on its tortuous path to the central outlet. The expansion takes place chiefly along the spiral path, for the spread inward is opposed by the centrifugal force due to the velocity of the whirl and by the great resistance to radial exhaust. It is to be observed that the resistance to the passage of the fluid between the plates is, approximately, proportionate to the square of the relative speed, which is maximum in the direction toward the center and equal to the full tangential velocity of the fluid. The path of least resistance, necessarily taken in obedience to a universal law of motion is, virtually, also that of least relative velocity. Next, assume that the fluid is admitted to the disk chamber not through a port, but a diverging nozzle, a device converting wholly or in part, the expansive into velocity-energy. The machine will then work rather like a turbine, absorbing the energy of kinetic momentum of the particles as they whirl, with continuously decreasing speed, to the exhaust.

The above description of the operation, I may add, is suggested by experience and observation, and is advanced merely for the purpose of explanation. The undeniable fact is that the machine does operate, both expansively and impulsively. When the expansion in the nozzles is complete, or nearly so, the fluid pressure in the peripheral clearance space is small; as the nozzle is made less divergent and its section enlarged, the pressure rises, finally approximating that of the supply. But the transition from purely impulsive to expansive action may not be continuous throughout, on account of critical states and conditions and comparatively great variations of pressure may be caused by small changes of nozzle velocity.

In the preceding it has been assumed that the pressure of supply is constant or continuous, but it will be understood that the operation will be, essentially the same if the pressure be fluctuating or intermittent, as that due to explosions occurring in more or less rapid succession.

A very desirable feature, characteristic of machines constructed and operated in accordance with this invention, is their capability of reversal of rotation. Fig 1, while illustrative of a special case, may be regarded as typical in this respect. If the right hand valve be shut off and the fluid is rotated in the direction of the dotted arrow, the operation, and also the performance remaining the same as before, the central ring being bored to a circle with this purpose in view. The same result may be obtained in many other ways by specially designed valves, ports, or nozzles for reversing the flow, in the description of

which is omitted here in the interest of simplicity and clearness. For the same reasons but one operative port or nozzle is illustrated which might be adapted to a volute but does not fit best a circular bore. It will be understood that a number of suitable inlets may be provided around the periphery of the runner to improve the action and that the construction of the machine may be modified in many ways.

Still another valuable and probably as unique quality of such motors or prime movers may be described. By proper construction and observance of working conditions the centrifugal pressure, opposing the passage of the fluid, may, as already indicated, be made nearly equal to the pressure of supply when the machine is running idle. If the inlet section be large, small changes in the speed of revolution will produce great differences in flow which are further enhanced by the concomitant variations in the length of the spiral path. A self regulating machine is thus obtained bearing a striking resemblance to a direct-current electric motor in this respect that, with great differences of impressed pressure in a wide open channel the flow of the fluid through the same is prevented by virtue of rotation. Since the centrifugal head increases as the square of the revolutions, or even more rapidly, and with modern high grade steel great peripheral velocities are practical, it is possible to attain that condition in a single stage machine, more readily if the runner be of large diameter. Obviously this problem is facilitated by compounding, as will be understood by those skilled in the art. Irrespective of its bearing on economy, this dependency which is, to a degree, common to motors of the above description, is of special advantage in the operation of large units, as it affords a safeguard against running away and destruction. Besides these, such a prime mover possesses many other advantages, both constructive and operative. It is simple, light, and compact, subject to but little wear, cheap and exceptionally easy to manufacture as small clearances and accurate milling work are not essential to good performance. In operation it is reliable, there being no valves, sliding contacts or troublesome varies. It is almost free of windage, largely independent of nozzle efficiency and suitable for high as well as for low fluid velocities and speeds of revolution.

It will be understood that the principles of construction and operation above generally set forth, are capable of embodiment in machines of the most widely different forms, and adapted for the greatest variety of purposes. In my present specification I have sought to describe and explain only the general and typical applications of the principle which I believe I am the first to realize and turn to useful account.

What I claim is:

1. A machine adapted to be propelled by a fluid consisting in the combination with a casing having inlet and outlet ports at the peripheral and central portions, respectively, of a rotor having plane spaced surfaces between which the fluid may flow in natural spirals and by adhesive and viscous action impart its energy of movement to the rotor, as described.
2. A machine adapted to be propelled by a fluid, comprising a rotor composed of a plurality of plane spaced disks mounted on a shaft and open at or near the same, an inclosing casing with a peripheral inlet or inlets, in the plane of the disks, and an outlet or outlets in its central portion, as described.
3. A rotary engine adapted to be propelled by adhesive and viscous action of a continuously expanding fluid comprising in combination a casing forming a chamber, an inlet, or inlets

- tangential to the periphery of the same, and an outlet or outlets in its central portion, with a rotor composed of spaced disks mounted on a shaft, and open at or near the same, as described.
4. A machine adapted to be propelled by fluid, consisting in the combination of a plurality of disks mounted on a shaft and open at or near the same, and an inclosing ring casing with ports or passages of inlet and outlet at the peripheral and central portions, respectively, the disks being spaced to form passages through which the fluid may flow, under the combined influence of radial and tangential forces, in a natural spiral path from the periphery toward the axis of the disks, and impart its energy of movement to the same by its adhesive and viscous action thereon, as set forth.
 5. A machine adapted to be propelled by a fluid comprising in combination a plurality of spaced disks rotatably mounted and having plane surfaces, an inclosing casing and ports or passages of inlet and outlet adjacent to the periphery and center of the disks, respectively, as set forth.
 6. A machine adapted to be propelled by a fluid comprising in combination a runner composed of a plurality of disks having plane surfaces and mounted at intervals on a central shaft, and formed with openings near their centers, and means for admitting the propelling fluid into the spaces between the disks at the periphery and discharging it at the center of the same, as set forth.
 7. A thermo-dynamic converter, comprising in combination a series of rotatably mounted spaced disks with plane surfaces, an inclosing casing, inlet ports at the peripheral portion and outlet ports leading from the central portion of the same, as set forth.
 8. A thermo-dynamic converter, comprising in combination a series of rotatably mounted spaced disks with plane surface and having openings adjacent to their central portions, an inclosing casing, inlet ports in the peripheral portion, and outlet ports leading from the central portion of the same, as set forth.

In testimony whereof I affix my signature in the presence of two subscribing witnesses.

NIKOLA TESLA

Witnesses:

M. Lawson Dyer

WM. Bohleber

COMPLETE SPECIFICATION

Improved Process of and Apparatus for Production of High Vacua

I, Nikola Tesla, Electrical and Mechanical Engineer, citizen of United State of America, of No. 8, West 40th Street, New York, NY, USA, do hereby declare the nature of this invention and in what manner the same is to be performed, to be particularly described and ascertained in and by the following statement:

In the development of power by thermodynamic prime movers, as steam engines and turbines, a low back pressure is essential to good economy, the performance of the machine being increased from fifty to one hundred per cent, by reducing the absolute pressure in the exhaust space from fifteen to about one pound per square inch. Turbines are particularly susceptible to such improvement and in their use for operation of power plants and manufacturing establishments the attainment and steady maintenance of high vacua has assumed great importance, every effort being made to better the conditions in this respect. The gain effected by this means is, in a large measure, dependent on the initial pressure, characteristics of the prime mover, temperature of the cooling medium, cost of the condensing apparatus and many other things which are all well-known to five to six per cent of fuel for each addition inch of vacuum is often closely approximated in modern installations, but the economic advantages are appreciably lessened when higher vacua are applied to existing machines purposely designed to operate with lower ones. More especially is this true of a turbine in which the reduction of back pressure merely increase the velocity of exit of the vapors without materially augmenting the speed of their impact against the vanes, buckets, or equivalent organs, when the loss of kinetic energy in the exhaust may offset a considerable portion of the useful work. In such cases some constructional changes in the turbine and auxiliaries may have to be made in order to secure the results here contemplated but the additional capital used for this purpose will be profitably invested. Summing up the situation it may be generally stated that a more or less substantial reduction of fuel cost can be made in most of the existing power plants by the adoption of proper pumping apparatus and establishment of working conditions nearly corresponding to those of an ideal condenser.

The chief difficulties which have thus far retard advancement in this direction are encountered in the enormous volumes of the air and vapor at very low pressure as well as unavoidable leaks in the condenser, pipe joints, valves, glands and stuffing boxes. At present exhaustion is usually accomplished by reciprocating pumps and these, on account of the necessarily low speed of the pistons are large and, moreover, incapable of satisfactory performance in the presence of big leaks. As a direct result of this the condensing plant is both bulky and expensive and, worse still, its size and cost increase entirely in disproportion to the results attained. To illustrate - the outlay involved in the installment of condensing apparatus for a twenty-eight inch vacuum is more than double that required for a vacuum of twenty-six inches and these draw-backs are still more emphasize with the further reduction of the back pressure. Rotary pumps and jets of water and steam are also used in the production of vacua, but without marked qualitative advantages.

I have achieved better success in departing from the customary method of removing the air and entrained steam from the condenser by bodily carriers as jets, reciprocating pistons or rotating vanes, and availing myself of the properties of adhesion and viscosity which, according to experimental evidence are retained by the gases and vapors even at very high degrees of attenuation. This new

process is rendered practicable through a pump, the underlying principle of which is fully explained in my British Patent 24,001 of 1910, but which is modified as hereinafter described and when run at the very great peripheral speed of which an unloaded system is capable, exhibits two remarkable and valuable properties. One of these is to expel the rarefied fluids at such an immense rate that a hole of some size can be drilled in the condenser without much effect on the vacuum gauge. The other is to draw out the fluids until the exhaustion is almost complete. A machine of this kind, constructed in stages, is alone sufficient for the production of extremely high vacua and I believe this quality to be very valuable inasmuch as it is not possessed to such a degree by other types of commercial pumps, which have come to my knowledge. I have also found that inserting my pump between the condenser and a "dry air" or other pump produces a very effective combination. This combination is especially advantageous from the practical point of view as good results can be secured with a single stage and the installment of my device calls for but a slight change in the steam plant. The benefits derived are twofold; a higher vacuum is attained and, what is perhaps more important, the frequent and unavoidable impairments of the same, which seriously affect the economy, are virtually eliminated. My pump makes possible the maintenance of high vacua even when the percentage of air or other fluids carried with the steam is very great and on this account should prove particularly useful in the operation of mixed fluid turbines.

My invention will be more fully understood by reference to the accompanying drawing in which Fig. 1 shows a multi-stage pump of this kind in sectional views, and Fig. 2 illustrates its use in connection with a double-acting reciprocating pump.

In the first figure, 1, 2, ... are rotors each of which, as 1, comprises a number of relatively thin disks 3, 3... separated by star-washers 4, 4... and held together by rigid endplates 5 and 6 on a sleeve 7 which is fitted and keyed to a shaft 8, rotatably supported in bearings 9, 9. The rotors are contained in separate chambers of a common structure 10, which surrounds them and is made up of parts held together by flange connections. Beginning with the first stage at 1, the rotors diminish in width, each following being made narrower than the preceding, for obvious economic reasons. All the thin discs, as 3, 3... and left-hand endplates, as 5, are provided with the usual central openings, but the right-hand end plates, as 6, are blank. The individual chambers, containing the rotors, communicate with each other through channels, as 11, extending from the peripheral region of one to the central part of the next, so that the fluids aspirated at the intakes 12, 12 are compelled to pass through whole series of rotors and are finally ejected at the flanged opening 13 of the last chamber. In order to reduce leakage along the shaft, close-fitting joints or locks, as 14, are employed which may be of ordinary construction and need not be dwelled upon specifically. The number of stages will depend on the peripheral velocity and the degree of exhaustion, which it is desired to secure, and in extreme cases a number of separate structures, with intermediate bearings for the shaft, may have to be provided. When found preferable the pump may be of the double-flow type, when there will be no appreciable side thrust, otherwise provision for taking it up should be made.

The modifications in details of construction, to which reference has been made, consist in the employment of smaller spaces between the discs than has hitherto been the case, and of close side-clearances. To give a practical example, I may state that spaces of $\frac{3}{64}$ of an inch will be effective in the production of very high vacua with discs of, say, 24 inches in diameter. I also make all discs tapering, when necessary, in order to operate safely at an extremely high peripheral velocity which is very desirable since it reflects both on the size of the machine and its effectiveness.

The arrangement represented diagrammatically in Fig. 2 is especially suitable and advantageous in connection with existing steam plants operating with high vacuum and permits the carrying out of my improvements in a simple manner and at comparatively small cost. In this case my pump, which may have but one rotor of the above description, is connected with its intake 12, through a pipe 15, to the top of a condenser 16, and with its discharge opening 13, by pipe 17, to the suction duct of a reciprocating dry air pump 18. It goes without saying that in actual practice connections 15 and 17 will be short mains of very large section as the volume of fluids to be pumped may be enormous.

The operation will be readily understood from the foregoing. The intakes 12 (Fig. 1) being joined by an air-tight connection to the vessel to be exhausted and the system of discs run at very high peripheral velocity the fluids, by reason of their properties of viscosity and adhesion, are drawn out of the vessel until the degree of rarefaction is attained for which the apparatus has been designed. In their passage through the series of rotors the fluids are compressed by stages and ejected through the opening 13 at a volume greatly reduced. The vacuum produced by this means may be extremely high because of the apparently unique properties of the device pointed out before and as the fluids, irrespective of their density, are sucked out at an excessive speed, leaks through the glands, stuffing boxes and connections are of but slight effect.

In the arrangement shown in Fig. 2 my pump serves to evacuate the condenser much more effectively and by compressing the fluids at the intake of the reciprocating pump improves the performance of the same. The installment of the devise in existing plants does not call for extensive alterations in the same and will result in a notable saving of fuel. My pump may also be advantageously employed in place of a steam jet in conjunction with a small condenser in which case it will be of insignificant dimensions and economical in steam consumption.

Fig. 1

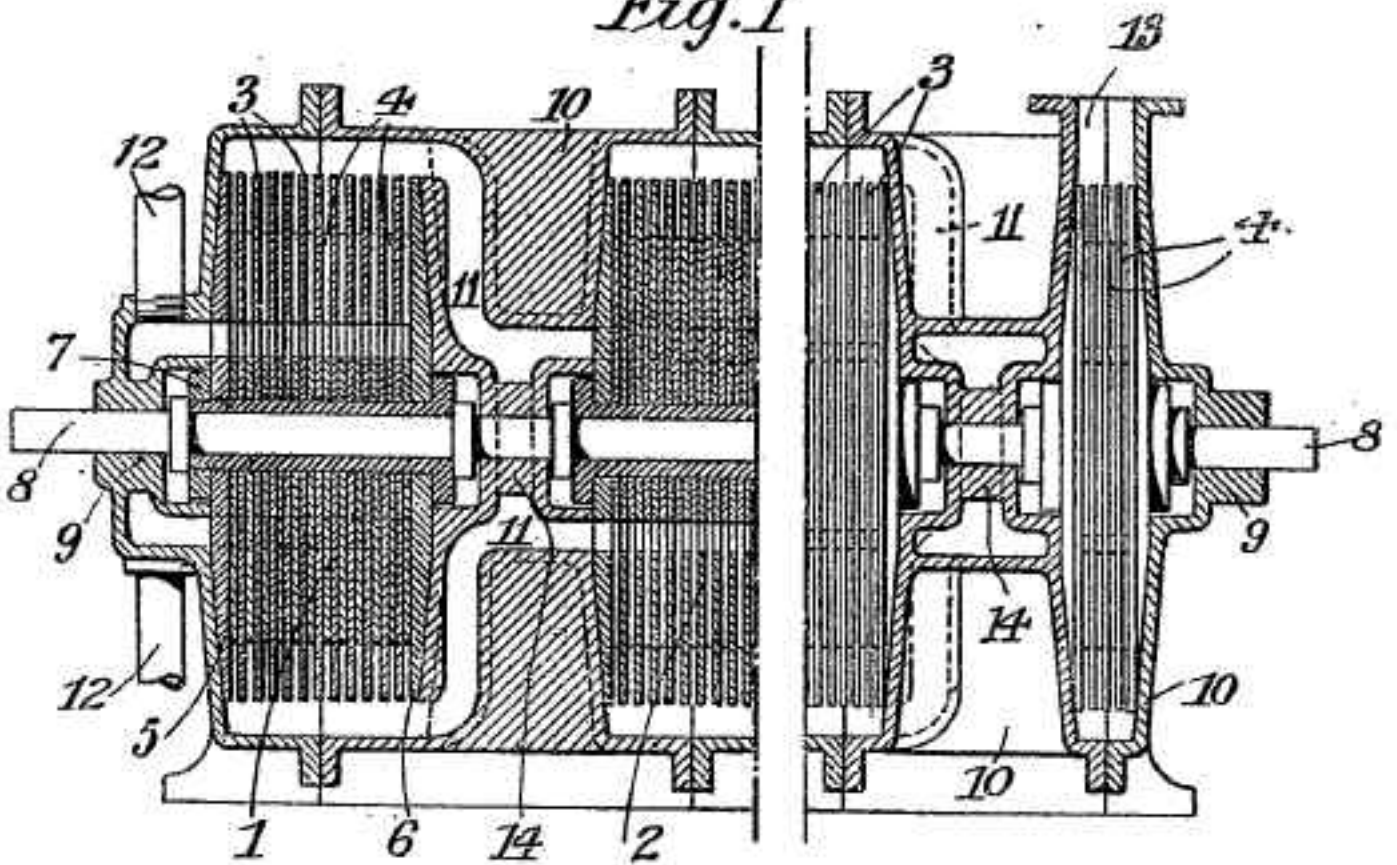
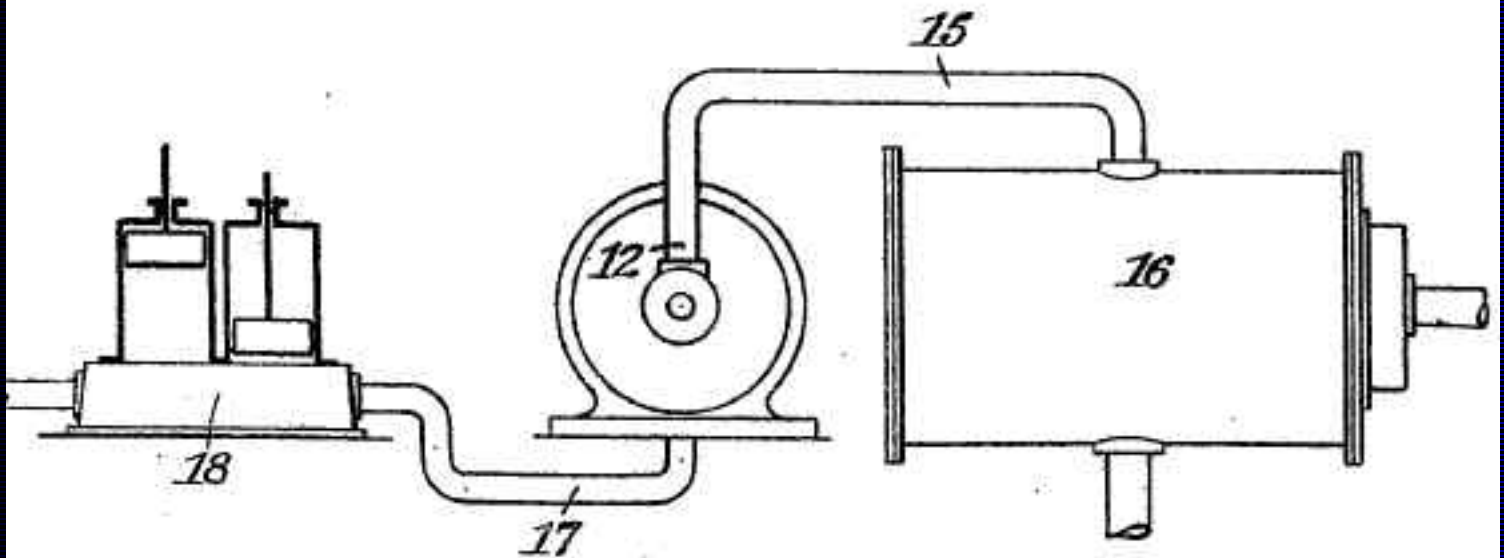

Fig. 2



[[INDEX](#)]



Researching a Shock-wave Tesla

Steam Turbine Locomotive

The concept of a boundary-layer turbine originated about a century ago, in the research of Nikola Tesla. Tesla's version of a boundary-layer turbine consists of a stack of closely spaced discs. A high-velocity of fluid is injected tangentially into the spaces between these discs, flowing inwardly in a spiral toward a centrally located exhaust. The drag between the surface of the discs and the fast moving fluid results in the conversion of fluid flow to mechanical power.

Most tests involving Tesla turbines have used subsonic flows of liquids or gases, with less than spectacular results. Unlike conventional bladed turbines that are subject to blade erosion, boundary layer turbines can operate when a partially saturated fluid is injected at supersonic speeds. Superheated steam is one fluid that can be injected into Tesla turbines under high-pressure and at supersonic speeds. When a fluid is accelerated to supersonic speeds, it undergoes a drop in both temperature and pressure. To generate the supersonic speed from a high-pressure region, the fluid first flows through a converging duct into a throat (minimum area cross-section) where sonic speed will be reached, then into a diverging duct where supersonic speeds will occur if the downstream pressure is low enough.

Supersonic flow develops when there is a large enough difference between the upstream and downstream pressures. Pressure reductions will occur in both the throat area as well as in the diverging duct. To ensure a high enough upstream pressure, a water tube boiler would need to generate at least 1,000-psia at 1,000-degrees F. Power output may be varied by adjusting steam mass-flowrates by using a series of valves. By varying mass-flowrates at constant pressure and temperature, steam flow speeds will remain essentially constant. The constant high flow speed over a wide range of mass-flowrates is essential to maximizing fluid friction within a boundary layer turbine. The dominant term in the mathematical equation of boundary layer drag friction, is the velocity-squared factor.

The power output and efficiency of a boundary layer turbine increase with both fluid flow velocities as well as with physical size. The length, over which the fluid flows, as well as the surface area with which it interacts, is also dominant factors. One of the terms that needs to be calculated, is the Reynold's number (a dimensional number that contains factors such as density, gravity, flow velocity, viscosity and a length factor). The higher the Reynold's number, the lower the friction or coefficient of friction. However, the product of velocity-squared and friction ($C_f \times V\text{-squared}$) increases even as the friction factor decreases at higher flow speeds. One of the idiosyncrasies of Tesla turbines is that if they are to develop higher levels of efficiency, they have to be of very large diameter (to maximize disc surface area). To reduce parasitic losses against the inside of the casing, they need to be of low height at the casing's inside circumferential surface, with at least 1-inch clearance between the casing and the upper and lower disc surfaces.

As flow speed exceeds the speed of sound, shock waves begin to appear. At sonic speed, the shock wave will appear in the throat section at lower upstream steam pressures. As steam pressure increases, the shock wave moves down toward the exit of the diffuser section, where it is called a "normal" shock wave. As the difference between upstream and downstream pressures increase, the shock wave becomes oblique at the diffuser (nozzle) exit (an over-expanded nozzle). Larger upstream and downstream pressure differences result in expansion waves forming at the exit (an under-expanded nozzle). In order to maintain a high relative speed between the rotating boundary-layer turbine and the incoming jet of fluid, very high subsonic and supersonic fluid flow speeds would be essential. Whereas shock waves (pre-ignition "pinging") can shatter pistons in internal combustion engines, Tesla turbines are immune to shock wave damage.

If a Tesla multi-disc turbine of 6'4" outer disc diameter (20-ft circumference) rotates at 4500-RPM or 1500-ft/sec at the disc edge, steam injected tangentially at a speed of 3500-ft/sec (Mach 2.0) into the discs would result in a relative speed of 2000-ft/sec. Steam leaving the water-tube boiler at 1,000-psia at 1000-deg F would drop to 540.5-psia and 793.7-deg F in the throat section and 420.2-deg F at the nozzle exit. The critical exit pressures are 129.7-psia and 573.7-psia. If the backpressure in the turbine is between these 2-values, oblique shock waves will emanate from the nozzle exit into the turbine. If the backpressure is above the higher value, a normal shock wave will appear at the exit. If the backpressure is below the lower value (e.g.; 50-psia downstream "resistance" pressure), expansion shock waves will blast forth from the nozzle exit and into the turbine at 3500-ft/sec. This will happen if the nozzle exit area is 1.746-times the throat area. Supersonic speed steam flowrates entering the Tesla turbine discs could be partially saturated, however, boundary-layer turbines can operate under such conditions (shock waves plus saturated steam) without damage.

The efficiency of turbines is a function of size, that is, large and more powerful turbines are more efficient. In a boundary layer turbine, the amount of surface contact area the working fluid is in contact with maximizes performance. If 30-discs were spaced 1/4-inch (0.25"), 29 x 2-sides would be presented to the vortex. If the main working area of the disc is 3'-outer diameter and 2-ft inner diameter, there would be 15.7-sq.ft area per side or a total of 900-sq.ft of interactive surface area. The effective working radius would be 2.5-ft. The density of the steam at 400-deg F is 0.25-lb/cu.ft and its kinematic viscosity is 3.56E-7 lbf-sec/sq.ft. With the discs rotating at 4800-RPM, the relative maximum speed between the steam vortex and the discs at a radius of 2.5' is 1500-ft/sec.

The power output of the turbine would be a function of the square of the relative velocity (between vortex and discs) x (the interactive surface area) x (the drag coefficient) x (the steam density) divided by 2 x gravity. The drag coefficient is a function of the Reynolds Number, which for a relative speed of 1500-ft/sec would be $Re = (1500 \times 2.5 \times 2 \times \pi) / 3.56E-7 = 6.6152E10$. To calculate friction coefficient, part of the Prandtl-Schlichting equation will be used, $0.455 / (\log Re) \exp 2.58 = 0.000976$. For a relative velocity of 1500-ft/sec, drag would be $(1500 \times 1500 \times 900 \times 0.000976 \times 0.25 / 2 \times 32.2) = 7676$ -lbf at 2.5-ft radius, or 19,190-lbf.ft torque at 4800-RPM (17,445-Horsepower). At a relative fluid/disc speed of 500-ft/sec, the drag coefficient would increase to 0.0011 and deliver 958-lbf at 2.5-ft for 2395-lbf.ft torque at 4800-RPM (2177-Horsepower). At a relative speed of 1000-ft/sec, torque would be 8897-lbf.ft at 4800-RPM (8131-Horsepower). With

an electrical conversion efficiency of 89%, 7237-Hp would reach the rim of the locomotive drive wheels, with 6,400-Hp being available at the drawbar to pull a train at 60-mi/hr on level track.

A variable geometry nozzle of rectangular cross-section (narrow and high) would be used to inject the steam (tangentially) into the turbine. Variable geometry rectangular intakes are used on supersonic aircraft. Adjustable cross-section areas for both the throat as well as the nozzle exit could maintain a constant area-ratio (1.746 for Mach 2.0) between the two, by using a curved plate on a pivot and connected to a mechanical linkage. The inlet would admit supersonic steam flow into the vortex at 3500-ft/sec over a wide range of mass flowrates, resulting from varying the cross section of the throat to a maximum of 1.5-square inches and allowing 16.56-lbs/sec of steam (1000-psia at 1000-degrees F at the boiler has 1505.4-Btu's/lb) with 24,930-Btu/sec to leave the boiler (35,260-horsepower).

If this flowrates corresponds to 17,445-Hp, efficiency between boiler and turbine shaft would be 49.47%. If this corresponds to the lower level of 8131-Hp, the turbine would operate at 23%-efficiency, between boiler and turbine shaft. At 6400-Hp at the drawbar, overall locomotive efficiency would be 18%. It is quite possible for a single-pass turbine to operate as high as 32%-efficiency. The water pump will require less than 1.5% of total output energy for a 1,000-psia water tube boiler. If the pump can deliver 17-lb/sec of water (62.4-lb/cu.ft), or 0.272-cu.ft/sec at 1000-psi (144000-lb/sq.ft) = 39,230-lbf-ft/sec = 71.32-Hp (100% -eff) or at 85%-efficiency = 84-Hp water pump demand to deliver 6,400-Hp at 60-mi/hr.

The centrifugal forces generated within a Tesla turbine tend to push higher density compressible fluid toward the outer edges of the discs. This increased density increases the skin friction between the fluid and the discs. The injection of shock waves into the high-density fluid sustains a rapidly swirling vortex, with the less dense fluid being pushed toward the central exhaust. When the injected steam passes through the shock waves, almost instantaneous pressure and temperature rises occur. The high density swirling mass presents a high backpressure, which needs to be overcome, despite pressure drops in the nozzle. The high-pressure water-tube boiler compensates for this loss in pressure.

The supersonic injection speed of the steam would produce shock waves upon initial entry into the turbine. As the vortex begins to swirl and the turbine accelerates, sub-sonic relative speed could develop between the vortex and the outer disc areas. Due to the parallel flow between the vortex and the circumference of the discs, any shock waves that result between the vortex and the discs would have very small deflection angles and result oblique shock waves. These weak shock wave regions will allow supersonic vortex velocities to continue downstream of the shock waves. This supersonic vortex speed allows for higher disc (turbine) rotational speeds and much higher turbine output power for its size. The subsonic relative speeds between turbine and outer vortex allows the fast moving steam flow to enter the spaces between the discs, with either no shock wave or a weak shock wave would developing, the latter having minimal efficiency losses.

At the low relative vortex/disc speeds, the flow may transform from turbulent to laminar as the vortex moves inward toward the central exit. A high-energy exhaust stream could be reheated and re-expanded in a second, lower-pressure turbine. The exhaust from the second turbine

could drive a third turbine, which would drive a compressor, re-compressing the exhaust steam leaving the higher-pressure power turbine and entering the lower-pressure power turbine. Such an arrangement would raise overall thermal energy efficiency of a Tesla turbine system. If a single large Tesla turbine can exceed 30% efficiency using supersonic speed steam flow in its vortex, a single-pass steam expansion may be cost-effective when low-cost renewable energy is converted.

To counter the gyroscopic effects of a Tesla turbine, a vertical shaft will need to be used (the unit may need to be mounted in gimbals, inside a 10-ft wide locomotive car body). An electric alternator may be mounted above the turbine. Flexible couplings may need to be used in the steam lines leading to the Tesla turbine, to compensate changes caused by locomotive pitching (gradient changes) and roll (tilting on curves). Boundary layer turbines are among the many options available to expand steam for traction generation in a renewable-fuel modern steam locomotive. There is a great deal of controversy involving the overall thermal efficiency of such turbines. The example described in this article is by no means an optimized system. There is scope to optimize its performance and refine its operation.

This fantastic article was written by Mr. Harry Valentine, harrycv@hotmail.com

[INDEX](#)

[HOME](#)

A Thermo-Pneumatic Tesla Turbine Locomotive

Pneumatic locomotives operating on compressed air were successfully used in coalmines over a period of several decades. The Porter Company (USA) built a model that used an 800-psi accumulator tank, an operating tank set at 280-psi and compound expansion piston engines. These original pneumatic locomotives operated successfully and safely over short distances (up to 60,000-ft) in tunnels, hauling ore cars out of mines. None of the locomotives that were used in both American and in Europe used an air heating system to increase power or raise operating efficiency.

Modern pressure vessel technology allows air to be stored at pressures of up to 45,000-psi (310-Mpa) in reinforced spherical tanks. For pneumatic locomotive operation, spherical tanks of up to 2.75m (external diameter) can hold compressed air at 10,000-psi (68.95-Mpa). Several such tanks may be installed on an articulated locomotive frame, holding up to 40,000-lb (18,000-Kg) of compressed air at 80-degrees F (26-degrees C), air which may be fed into these tanks from larger stationary accumulator tanks holding compressed air up to 20,000-psi (137.9-Mpa). This arrangement would allow for rapid replenishing of locomotive air supply. The stationary tanks may be replenished during off-peak hours, reducing demand for high-priced electric power. Extreme high pressure pumping of air into the stationary tanks would have to be undertaken in stages, with air-over-oil pumping technology being used to achieve pressures of 10,000-psi. Cooling of air under compression would be essential to maximize storage density.

The air-compression technology may operate in a combined cycle with either a building complex or district heating system, allowing for the reject heat obtained for air compression to be put to productive use during winter months. During summer months, the reject heat from air compression may also be used to drive new generation absorption building complex cooling systems. The reject heat from air compression may also contribute to the thermal energy supply being stored in a stationary thermal storage tank, for later transfer into the locomotive thermal storage tank. Both storage tanks could be made from corrosion resistant materials such as silicon-nitride, which could hold a compound such as molten aluminum (melts at 645-degrees C, 170-Btu/lb heat of fusion) or molten lithium carbonate (melts at 723-degrees C, 260-Btu/lb heat of fusion). Heating of the molten metal could be accomplished by using concentrated solar thermal energy, garbage incineration, and heat pumping of geothermal energy to a high temperature, biomass combustion, fusion energy or even fission energy (micro-nuclear, using low-radiation pebble-bed technology).

Simultaneous pressurization of the accumulators and heating of the thermal storage material is possible, using cascade heat pumping technology. A low temperature heat pumping circuit using sulphur dioxide could remove heat from the air as it is being compressed. It could reject heat at 260-deg F (125-deg C) with a coefficient of performance (COP) of 6:1 to 9:1, to a higher temperature heat pump circuit using a different working fluid, such as saturated water. The saturated water would be pumped at 80% compressor efficiency from a low pressure of 25-psia (240-deg F) to a high pressure of 250-psia (401 deg F), with a COP of 3.84:1 to 4:1. High temperature heat pumping circuits (COP's of 3:1) on stationary tanks could involve such working fluids as mercury or a mixture of 56% sodium and 44% potassium (circuit material and compressor made from silicon-nitride) to raise the temperature to melt aluminum or lithium

carbonate. The high temperature heat pumping could be supplemented with concentrated solar thermal energy during summer months (year round if the locomotives are in arid tropical nations).

To improve thermal efficiency while the locomotive is in operation, the compressed air would need to be heated to a high temperature, prior to expansion in an engine. The locomotive could be a 3-section articulated unit, with a thermal storage tank located at the centre, between the sections carrying the spherical pressure tanks. Cylindrical operating tanks set at 1,000-psi (6,895-Mpa) could be located below the spherical tanks. The operating tanks would feed air to the expander, via the thermal tanks. The on-board thermal tanks could also be made from silicon-nitride and contain molten aluminum or molten lithium carbonate. Heat transfer between stationary and mobile thermal tanks could be accomplished using superheated air as the heat transfer fluid, for reasons of safety.

One possible engine option for this application would be a relatively compact 3 or 4-stage Tesla turbine system. Exhaust air from a higher-pressure turbine would be reheated prior to expansion in a larger capacity lower-pressure turbine. The 3 to 4-stage compound reheat-expansion could raise adiabatic efficiency levels to over 90%. The Tesla turbine delivers optimal efficiency over a narrow range of operating speed, requiring the use of an electrical transmission. The power output of the Tesla turbine may be varied by varying inlet air pressure levels, at a constant maximum temperature. Inlet air velocity would need to vary between Mach 1 to Mach 1.25.

Heat transfer between stationary and mobile thermal tanks may use air being pumped through the heat transfer circuit using a compressor (a radial-flow bladed turbine) made from silicon-nitride, a material capable of handling extremes of temperature. The multi-pass air lines required to heat the mobile tank would each contain a series of venturies, each causing a successive pressure drop of 0.528 and a successive temperature drop of 0.833 (absolute temperature). After leaving the mobile tank, the heat exchanger air would pass through an air turbine, which would further reduce air temperature while driving a low-pressure air turbo-compressor placed upstream of the main compressor. The airline inside each stationary tank would contain a series of multi-pass tubes, to enhance the transfer of heat. With an adiabatic efficiency of 80%, the compressor would raise the temperature being fed into the mobile thermal tank.

If the compressor has a pressure ratio of 4:1, it would raise absolute air temperature by 48.6%, while a 6:1 pressure ratio would see a 66.85% rise in absolute temperature. If the air leaving the stationary tank is at 1350-degrees R, it would rise to 2170-deg R (1710-deg F) using a 4:1 pressure ratio at 80% adiabatic compressor efficiency. Using a 6:1 pressure ratio, this would increase temperature to 2478-deg R (2018-deg F/1103-deg C) at 80% compressor adiabatic efficiency. Absolute temperatures entering the mobile tanks could be raised an extra 6% - 10%, by using a diffuser downstream of the compressor. This could raise heating temperature to 2166-degrees F (1185-deg C), sufficient to rapidly remelt/reheat the aluminum or lithium carbonate during a thermal recharge.

While the locomotive is in operation, the maximum air mass flow rate passing through the engine could be set between 10,000-lb/hr to 15,000-lb/hr. With a 40,000-lb maximum compressed air capacity (density of 49.98-lb/cu.ft), the usable air supply could last for 2 to 3-

hours. With 1,000-psi operating tank pressure and 14.7-psi atmospheric pressure (assume exhaust to atmosphere), the outlet pressure ration would be 68:1, which would translate to an absolute temperature ratio of 3.339 at 100% adiabatic expansion efficiency. With molten aluminum held at 645-degrees C (1193-degrees F), the air could be heated to 1000-deg F prior to expansion. In a single stage expansion, exhaust air would drop to -22.75-deg F, yielding a temperature drop of 1022.75-deg F. Multiplying this by an air specific heat of 0.24-Btu/lb-deg R, an adiabatic efficiency of 90% and a mass flow rate of 10,000-lb/hr, dividing by 2545-Btu/Hp-hr, yields 868-Hp. Increasing air mass flow rate to 15,000-lb/hr raises power to 1302-Hp. This power level allows the locomotive to pull a short commuter train for up to 2-hours at speeds of 60-miles/hour.

Using lithium carbonate as thermal storage material could raise air temperature to 1140-deg F, dropping to 19-deg F after expansion (100% adiabatic efficiency). At 90% adiabatic engine efficiency (single pass expansion), the engine would deliver 951-HP using 10,000-lb-air/hr (1427-Hp using 15,000-lb-air/hr). Using the Tesla turbine engine in a multi-stage reheat expansion system, would economize on air consumption and increase locomotive operating duration/distance, enabling short-distance intercity routes up to 150-miles to be served at moderate rates of speed. Using heat pumping between the thermal tanks to further heat the air may be possible, using a corrosion resistant heat pump circuit and compressor made from silicon-nitride. Possible working fluids would include mercury or a sodium/potassium mixture, enabling COP's of at least 3:1 (this is the minimum COP that will yield a net gain), enabling a net of 1250-Hp at 10,000-lb-air/hr (1875-Hp at 15,000-lb-air/hr). High COP heat pumping could raise compressed air temperatures to 1600 to 1800-deg F prior to expansion, raising engine efficiency levels sufficiently to allow for power to be used to drive the heat pump compressor (240 to 340-Hp for a COP over 3:1; a COP of 1:1 requires 950-Hp at the compressor and yields zero net gain) .

Further improvements in locomotive performance are possible, using "renewable combustion" technology. Certain chemical compounds release heat during bonding and dissociate when heated to a high temperature. Magnesium hydride is one such compound, while potassium oxide is another. During heating, the hydrogen can be disassociated from the magnesium and stored in a separate chamber, or oxygen from potassium. In operation, the heat of formation of the magnesium hydride or potassium oxide could be used to superheat the air prior to expansion in the engine. Some "renewable combustion" combinations (heat of formation) could heat the air to 2000-deg F prior to expansion and raise exhaust temperature to 276-deg F, allowing heat from exhaust air to be re-introduced into the operating tank and into the spherical accumulators, which would be cooling as internal pressure dropped. Recirculating reject heat would further increase the operating range of the thermo-pneumatic locomotive.

Heat from the atmosphere could be heat-pumped into the accumulators to reduce pressure loss during operation. With 2000-deg F air temperature, 1465-Hp would be available at 90% single-pass adiabatic efficiency, using 10,000-lb-air/hr (3-hours in service operation at speeds up to 75-mi/hr or 120-Km/hr) while 2193-Hp would become available over 2-hours using 15,000-lb-air/hr (train speed 90-mi/hr or 1145-Km/hr). Heat exchangers made from silicon-carbide may be used in the high-temperature heating of the compressed air, whether from "renewable combustion" or from combustion of a fuel that would otherwise be unsuitable for use in an internal combustion piston engine (e.g.: low-rank coal-water fuel, corrosive liquid fuels or

similar gaseous fuels). These fuels may either destroy engine lubrication or build sludge and engine deposits that would impair efficient internal combustion engine operation. External combustion engines can yield lower exhaust pollutant emission levels, due to greater scope to manage and refine the combustion process.

In a resource constrained future where oil prices rise to 3 to 4-time present day levels, a thermo-pneumatic Tesla turbine locomotive may be able to operate some types of commuter train services and short-distance intercity passenger train services, both along relatively low-density routes where the cost of railway electrification could not be justified. Alternatively, a thermo-pneumatic Tesla turbine locomotive could operate along rail lines in small nations. Such a locomotive and its energy storage systems would have longer longevity than present competing technologies, resulting in less need to replace worn or expended parts.

[INDEX](#)

[HOME](#)

Another fine article by Mr. Harry Valentine; harrycv@hotmail.com

Tesla's Fuelless Generator



In the 1880's, Nikola Tesla invented the alternating current system we use today. By the 1890's, he was working on a new type of electrical generator that would not "consume any fuel."

This paper documents where in his writings the description of this new generator is found, a theory of how a fuelless generator could work and a suggestion as to how Tesla's new device might have operated.

Return to [Table of Contents](#)

NIKOLA TESLA'S LATER ENERGY GENERATION DESIGNS

Oliver Nichelson
333 North 760 East
American Fork, Utah 84003 USA

© 1991

ABSTRACT

Ten years after patenting a successful method for producing alternating current, Nikola Tesla claimed the invention of an electrical generator that would not "consume any fuel." Such a

generator would be its own prime mover. Two of Tesla's devices representing different stages in the development of such a generator are identified.

INTRODUCTION

While in college Nikola Tesla claimed it should be possible to operate an electrical motor without sparking brushes. He was told by the professor that such a motor would require perpetual motion and was therefore impossible. In the 1880's he patented the alternating current generator, motor, and transformer.

During the 1890's he intensively investigated other methods of power generation including a charged particle collector patented in 1901. When the *New York Times* in June of 1902 carried a story about an inventor who claimed an electrical generator not requiring a prime mover in the form of an external fuel supply, Tesla wrote a friend that he had already invented such a device.

Fuelless electrical generation raises the same objection of perpetual motion as did the generator in use today when it was first proposed. Research Nikola Tesla carried out during his second creative period and the resulting devices that were the basis for his assertion of fuelless electrical generation will be examined. Whether Tesla's fuelless generator was a "perpetual motion scheme" of the sort his teacher warned him against, or a creative application of recognized natural phenomena will be discussed.

TESLA'S STATEMENTS

In *The Brooklyn Eagle*, Tesla announced, on July 10th, 1931, that "I have harnessed the cosmic rays and caused them to operate a motive device." Later on in the same article he said that "More than 25 years ago I began my efforts to harness the cosmic rays and I can now state that I have succeeded." In 1933, he made the same assertion in an article for the *New York American*, November 1st, under the lead in "Device to Harness Cosmic Energy Claimed by Tesla." Here he said:

This new power for the driving of the world's machinery will be derived from the energy which operates the universe, the cosmic energy, whose central source for the earth is the sun and which is everywhere present in unlimited quantities.

Dating back "more than 25 years ago" from 1933 would mean that the device Tesla was speaking about must have been built before 1908. More precise information is available through his correspondence in the Columbia University Library's collection. Writing on June 10th, 1902 to his friend Robert U. Johnson, editor of *Century Magazine*, Tesla included a clipping from the previous day's *New York Herald* about a Clemente Figueras, a "woods and forest engineer" in Las Palmas, capital of the Canary Islands, who had invented a device for generating electricity without burning fuel. What became of Figueras and his fuelless generator is not known, but this announcement in the paper prompted Tesla, in his letter to Johnson, to claim he had already developed such a device and had revealed the underlying physical laws.

IDENTIFYING THE INVENTION

The device that, at first, seems to best fit this description is found in Tesla's patent for an "Apparatus for the Utilization of Radiant Energy," number 685,957, that was filed for on March 21, 1901 and granted on November 5, 1901. The concept behind the older technical language is a simple one. An insulated metal plate is put as high as possible into the air. Another metal plate is put into the ground. A wire is run from the metal plate to one side of a capacitor and a second wire goes from the ground plate to the other side of the capacitor. Then:

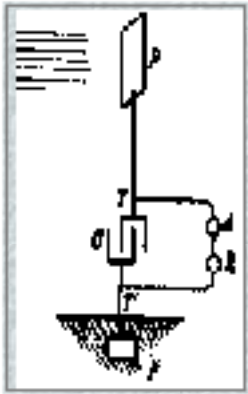

The sun, as well as other sources of radiant energy, throw off minute particles of matter positively electrified, which, impinging upon [the upper] plate, communicate continuously an electrical charge to the same. The opposite terminal of the condenser being connected to ground, which may be considered as a vast reservoir of negative electricity, a feeble current flows continuously into the condenser and inasmuch as the particles are ... charged to a very high potential, this charging of the condenser may continue, as I have actually observed, almost indefinitely, even to the point of rupturing the dielectric⁽¹⁾.

1. Particle
Collector

This seems like a very straightforward design and would seem to fulfill his claim for having developed a fuelless generator powered by cosmic rays, but in 1900 Tesla wrote what he considered his most important article in which he

describes a self-activating machine that would draw power from the ambient medium, a fuelless generator, that is different from his Radiant Energy Device. Entitled "The Problem of Increasing Human Energy - Through the Use of the Sun," it was published by his friend Robert Johnson in *The Century Illustrated Monthly Magazine* for June 1900 soon after Tesla returned from Colorado Springs where he had carried out an intensive series of experiments from June 1899 until January of 1900.

The exact title of the chapter where he discusses this device is worth giving in its entirety:

A DEPARTURE FROM KNOWN METHODS - POSSIBILITY OF A "SELF ACTING" ENGINE OR MACHINE, INANIMATE, YET CAPABLE, LIKE AN LIVING BEING, OF DERIVING ENERGY FROM THE MEDIUM - THE IDEAL WAY OF OBTAINING MOTIVE POWER

Tesla stated he first started thinking about the idea when he read a statement by Lord Kelvin who said it was impossible to build a mechanism capable of abstracting heat from the surrounding medium and to operate by that heat. As a thought experiment Tesla envisioned a very long bundle of metal rods, extending from the earth to outer space. The earth is warmer than outer space so heat would be conducted up the bars along with an electric current. Then, all that would be needed is a very long power cord to connect the two ends of the metal bars to a motor. The motor would continue running until the earth was cooled to the temperature of outer space. "This would be an inanimate engine which, to all evidence, would be cooling a portion of the medium below the temperature of the surrounding, and operating by the heat abstracted⁽²⁾," that is, it would produce energy directly from the environment without "the

consumption of any material."

Tesla goes on in the article to describe how he worked on the development of such an energy device, and here it takes a bit of detective work to focus on which of his inventions he meant. He wrote that he first started thinking about deriving energy directly from the environment when he was in Paris during 1883, but that he was unable to do much with the idea for several years due to the commercial introduction of his alternating current generators and motors. It was not "until 1889 when I again took up the idea of the self-acting machine⁽³⁾."

THE TURBINE

He quickly came to realize that an ordinary electrical machine, like his generator, would not be able to directly extract energy from the cosmos and turned his efforts to what he called a "turbine" design.

The best known turbine, that is, water pump, associated with Tesla is his patent for such a device, #1,061,206, which was filed for in 1909 and granted in 1913. The unique point about this water pump is that instead of using some form of paddle wheels inside a box to move the water, he discovered that more water could be moved faster by using a set of flat metal disks. The turbine is, in itself, fascinating and may yet prove to be another important overlooked invention, but what is of concern regarding the electrical design is the general shape of the turbine - metal disks turning inside a supporting box.

This same shape turns up in another patent, this one for a "Dynamo-Electric Machine." This patent was filed and granted in the same year that Tesla said he returned to work on the "self-activating" machine, in 1889. The dynamo consists of metal disks that are rotated between magnets to produce an electric current.

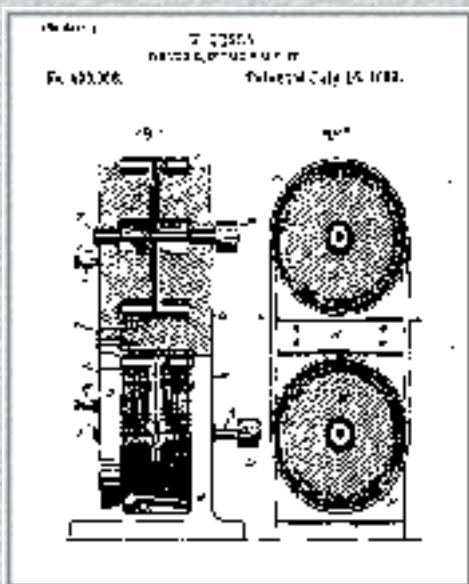

Compared to his alternating current generator, this "dynamo" represents something of a curious throwback to the days of Faraday's early experiments with a copper disk and a magnet. Tesla makes some improvement over the Faraday setup by using magnets that completely cover the spinning metal disks and he also adds a flange to the outside of the disks so current can be taken off more easily - all of which makes for a better generator than Faraday's. On the surface, though, it is hard to see why Tesla patented such an anachronistic machine at this point in his work.

The next piece of the puzzle is found in an article Tesla wrote for *The Electrical Engineer* in 1891 entitled "Notes on a Unipolar Dynamo." Here Tesla presents an in-depth analysis of the Faraday disk generator, explains why it was an inefficient generator, describes his improved variations on the Faraday machine, and, at the bottom of the third page of the article, states that he has devised a

2. Dynamo Electric Machine

generator in which "the current, once started, may then be sufficient to maintain itself and even increase in strength⁽⁴⁾." Then, at the close of the article, he states that "several machines ... were constructed by the writer two years ago ..." ⁽⁵⁾ Two years before the writing of that article was 1889. All the evidence points to the turbine-shaped Unipolar Dynamo as being Tesla's first design for a machine that can continue to produce electricity after being disconnected from an outside source of power.

SELF-SUSTAINING CURRENT

Before going into the details of this invention it would be worthwhile to have an idea of how any generator, even in theory, could be capable of producing a self-sustaining current. This has been clearly explained by Walter M. Elsasser in a *Scientific American* article (May 1958) titled "The Earth as a Dynamo."

Elsasser models the earth-dynamo, conveniently for this explanation, on the Faraday generator of a metal disk spinning over a bar magnet placed at the edge of the disk. He notes, also, that the bar magnet could be replaced by an electromagnet which could get its power from the spinning disk by attaching one end of the electromagnet's wire to the outside of the disk and the other end of the wire to the metal rod running through the center of the disk.

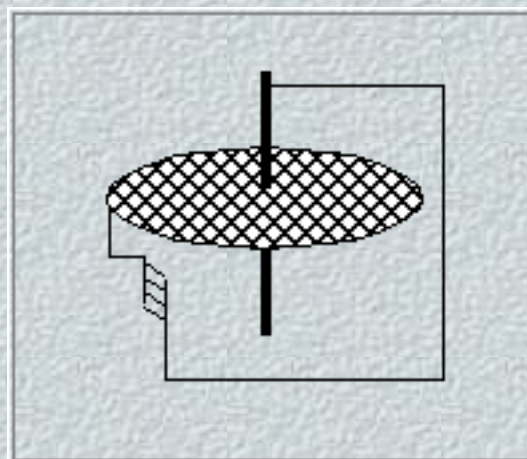

3. Faraday Generator with electromagnet

Elsasser then points out that an ordinary disk generator "could not maintain a current for very long because the current induced in the disk is so weak that it would soon be dissipated by the resistance of the conductor [the disk]." This conventional arrangement would not be an answer to "how currents could be built up and perpetuated to maintain the earth's magnetic field." He does, though, propose three options in the dynamo model that would explain the earth's persistent magnetism.

If we had a material that could conduct electricity a thousand times better than copper, the system would indeed yield a self-sustaining current. We could also make it work by spinning the disk very fast... a third way we could make such a dynamo self-sustaining ... is to increase the size of the system: theory says that the bigger we make such a dynamo, the better it will function. If we could build a coil-and-disk apparatus of this kind of scale of many miles, we would have no difficulty in making the currents self-sustaining⁽⁶⁾.

Tesla did not have a material a thousand times more conductive than copper, neither was he able to spin a disk at the ultra-high speeds needed to produce such a current, nor did he plan on using a piece of rotating metal several miles in diameter. What he did was to use energy that

is usually wasted in a generator and turn it into a source of power.

UNIPOLAR DYNAMO

Tesla's design varied from that of Faraday in two major ways. First, he used a magnet that was bigger in diameter than the disk so that the magnet completely covered the disk. Second, he divided the disk into sections with spiral curves radiating out from the center to the outside edge.

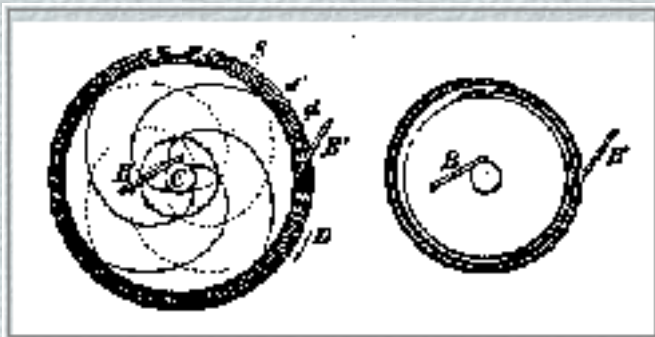

4. Tesla's Unipolar Generator

In the Faraday unipolar generator "the current," as Tesla noted, "set up will therefore not wholly pass through the external circuit ... and ... by far the greater portion of the current generated will not appear externally..."⁽⁷⁾ By having the magnet completely cover the disk, Tesla made use of the whole disk surface in current generation instead of only a small section directly adjacent to the bar magnet, as happened in the Faraday device. This not only increases the amount of current generated, but, by

making the current travel from the center to the outside edge, makes all of that current accessible to the external circuit.

More importantly, these modifications on the Faraday design eliminated one of the biggest problems in any physical system - the reaction to every action. It is this reaction that works to cancel out whatever effort goes into causing the original action. In an electrical system if there are two turns of wire wound next to each other and a current is sent through the wire, the current passing through the first loop will set up a magnetic field that will work against the current passing through the second loop.

The spiral divisions in the disk cause the current to travel the full radius of the disk or, as in his alternative version of the generator, to make a full trip around the outside edge of the disk. Because the current is flowing in a large circle at the rim of the disk, the magnetic field created by the current not only does not work against the field magnet above the circular plate, as in conventional generators, but it actually reinforces the magnet. So as the disk cuts the magnetic lines to produce a current, the current coming off of the disk strengthens the magnet, allowing it to produce even more current.

Like conventional direct current generators, the unipolar dynamo also functions as a motor if current is put into the disk while under the magnet, and this seems to be the last element that could make the device self-sustaining, that is, capable of generating a current after being disconnected from an outside source of movement like falling water or steam.

Rotation is started by, say, a motor powered by line current. Both a generator and a motor disk are mounted in the magnetic enclosure. As the disks gain speed, current is produced which, in turn, reinforces the magnets, which cause more current to be generated. That current is, likely,

first directed to the motor disk which increases the speed of the system. At a certain point the speed of the two disks is great enough that the magnetic field created by the current has the strength to keep the dynamo/motor going by itself.

What process might have kept the unipolar dynamo operating after the powered start-up is speculation at this point, however two features of the generator are significant. First, when a resistive load, like a light bulb is added to the circuit, it lowers the voltage at the center of the disk. This lower voltage at the center means that there is a greater difference in voltage between the center and the outside edge of the disk than there was before the light bulb was added. As the difference between the center and the outside increases, the dynamo works harder and makes more current. Second, yet more important, the dynamo takes either very little, or no energy to keep going because the current coming off the generator is doing double duty. The current makes the bulb glow, but on its way from the generator to the filament in the bulb, it travels a path that adds to the momentum of the dynamo and, therefore, consumes energy at a very low rate. The process continues, it would seem, until heat losses in the filament equal the rotational energy of the generator's flywheel.

In terms of Elsasser's criteria for a self-sustaining generator, the Tesla unipolar dynamo comes closest to satisfying the condition of a better electrical conductor. It is not that a new material is used, but a new geometry is applied so that the current does not create its own opposing forces. This is similar, but not equivalent, to having a better conductor.

Whether or not the dynamo is in fact a "fuelless" generator it appears to be an ingenious feat of engineering that takes one of the basic principles of nature, an equal and opposite action for every action, and turns it, by the use of a novel circuit geometry, into a reaction that is additive to the original action. Instead of the opposite reaction slowing down the system that created it, the reaction adds energy to the system.

Tesla, however, was not satisfied with his mechanical self-sustaining generator. The dynamo would provide the energy to run a single machine, but his vision was to light cities and in the 1900 *Century* magazine article he elaborated on the theory of such a machine.

Imagine, he suggested, an enclosed cylinder with a small hole in it near the bottom. Let us say that this cylinder, he added, contains very little energy but that it is placed in an environment that has a lot of energy. In this case, energy would flow from the outside environment, the high energy source, through the small opening at the bottom of the cylinder, and into the cylinder where there is less energy. Also suppose that as the energy passing into the cylinder is converted into another form of energy as, for example, heat is converted into mechanical energy in a steam engine. If it were possible to artificially produce such a "sink" for the energy of the ambient medium then "we should be enabled to get at any point of the globe a continuous supply of energy, day and night(8)."

He continued, in the article, to elaborate on his energy pump but changed the image slightly. On the surface of the earth we are at a high energy level and can imagine ourselves at the bottom of a lake with the water surrounding us equal to the energy in the surrounding medium.

If a "sink" for the energy is to be created in the cylinder, it is necessary to replace the water that would flow into the tank with something much lighter than water. This could be done by pumping the water out of the cylinder, but when the water flowed back in, we would only be able to perform the same amount of work with the inflowing water as we did when it was first pumped out. "Consequently nothing would be gained in this double operation of first raising the water and then letting it fall down."

Energy, though, can be converted into different forms as it passes from a higher to a lower state. He said, "assume that the water, in its passage into the tank, is converted into something else, which may be taken out of it without using any, or by using very little power⁽⁹⁾." For example, if the energy of the ambient medium is taken to be the water, oxygen and hydrogen making up the water are the other forms of energy into which it could change as it entered the cylinder.

Corresponding to this ideal case, all the water flowing into the tank would be decomposed into oxygen and hydrogen ...and the result would be that the water would continually flow in, and yet the tank would remain entirely empty, the gases formed escaping. We would thus produce, by expending initially a certain amount of work to create a sink for...the water to flow in, a condition enabling us to get any amount of energy without further effort⁽¹⁰⁾.

Tesla recognized that no energy conversion system would be perfect, some water would always get into the tank, but "there will be less to pump out than flows in, or, in other words, less energy will be needed to maintain the initial condition than is developed [by the incoming water], and this is to say that some energy will be gained from the medium⁽¹¹⁾."

He found that this pumping could be done with a piston "not connected to anything else, but was perfectly free to vibrate at an enormous rate⁽¹²⁾." This he was able to do with his "mechanical oscillator," a steam-driven engine used for producing high frequency currents. The faster the pump would work, the more efficient it would be at extracting energy from the cosmos. Research along this line culminated in the oscillator demonstrated at the Chicago World's Fair in 1893. It was not until much later, in the 1900 article, he revealed: "On that occasion I exposed the principles of the mechanical oscillator, but the original purpose of this machine is explained here for the first time ⁽¹³⁾."

It was also in 1893 that Tesla applied for a patent on an electrical coil that is the most likely candidate for a non-mechanical successor of his energy extractor. This is his "Coil for Electro-magnets," patent #512,340. It is another curious design because, unlike an ordinary coil made by turning wire on a tube form, this one uses two wires laid next to each other on a form but with the end of the first one connected to the beginning of the second one.

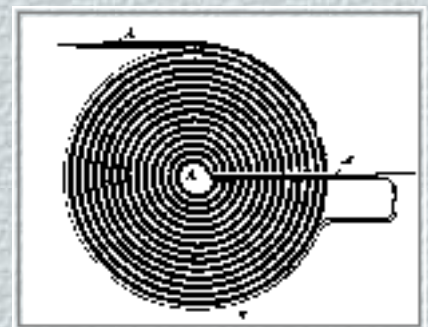

5. Coil for Electro-
Magnets

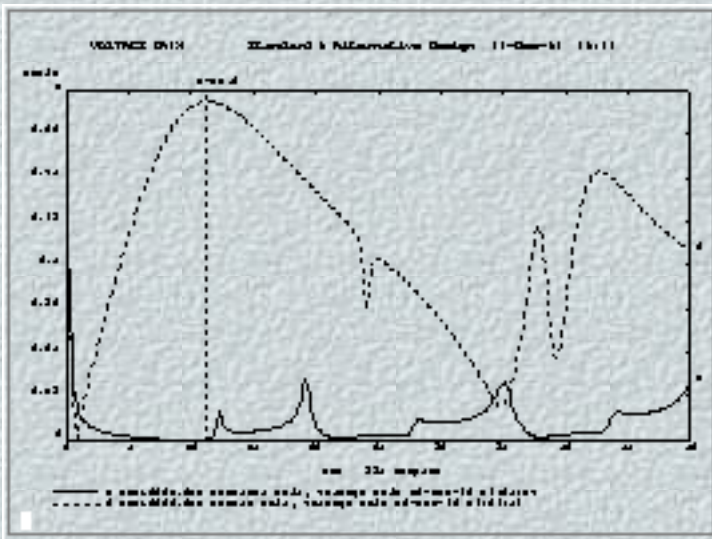

6. Voltage gain comparison

In the patent Tesla explains that this double coil will store many times the energy of a conventional coil(14). Preliminary measurements of two helices of the same size and with the same number of turns, one with a single, the other with a bifilar winding, show differences in voltage gain(15). In figure 6, the upper curve is from the Tesla design, the lower was produced by the single wound coil. The patent, however, gives no hint of what might have been its more unusual capability.

In the *Century* article Tesla compares extracting energy from the environment to the work of other scientists who were, at that time, learning to

condense atmospheric gases into liquids. In particular he cited the work of a Dr. Karl Linde who had discovered what Tesla described as a "self-cooling" method for liquefying air. As Tesla said, "This was the only experimental proof which I was still wanting that energy was obtainable from the medium in the manner contemplated by me(16)."

What ties the Linde work with Tesla's electromagnet coil is that both of them used a double path for the material they were working with. Linde had a compressor to pump the air to a high pressure, let the pressure fall as it traveled through a tube, and then used that cooled air to reduce the temperature of the incoming air by having it travel back up the first tube through a second tube enclosing the first(17). The already cooled air added to the cooling process of the machine and quickly condensed the gases to a liquid.

Tesla's intent was to condense the energy trapped between the earth and its upper atmosphere and to turn it into an electric current. He pictured the sun as an immense ball of electricity, positively charged with a potential of some 200 billion volts. The earth, on the other hand, is charged with negative electricity. The tremendous electrical force between these two bodies constituted, at least in part, what he called cosmic energy. It varied from night to day and from season to season but it is always present.

The positive particles are stopped at the ionosphere and between it and the negative charges in the ground, a distance of 60 miles, there is a large difference of voltage - something on the order of 360,000 volts. With the gases of the atmosphere acting as an insulator between these two opposite stores of electrical charges, the region between the ground and the edge of space traps a great deal of energy. Despite the large size of the planet, it is electrically like a capacitor which keeps positive and negative charges apart by using a non-conducting material as an insulator.

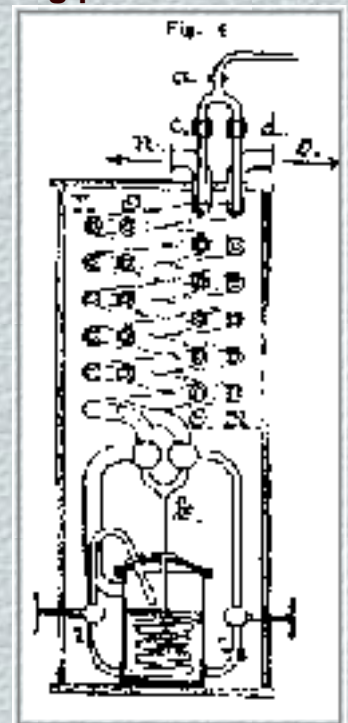

7. Linde's condenser

The earth has a charge of 90,000 coulombs. With a potential of 360,000 volts, the earth constitutes a capacitor of .25 farads (farads = coulombs/volts)⁽¹⁸⁾. If the formula for calculating the energy stored in a capacitor ($E = 1/2CV^2$) is applied to the earth, it turns out that the ambient medium contains 1.6×10^{11} joules or 4.5 megawatt-hours of electrical energy.

In order to tap this energy storehouse Tesla had to accomplish two things - make a "cold sink" in the ambient energy and devise a way of making the "sink" self-pumping. Explaining how this process might have worked requires, again, speculation.

Such a "sink" would have to be at a lower energy state than the surrounding medium and, for the energy to continually flow into it, the "sink" would have to maintain the lower energy state while meeting the power requirements of the load attached to it. Electrical energy, watt-seconds, is a product of volts x amps x seconds. Because the period of oscillation does not change, either voltage or current has to be the variable in the coil's energy equation.

In that the double wound coil maximizes the voltage difference between its turns, it is probable that it is the current that is minimized to produce a low energy state in the coil. For the coil to be initially "empty" and at low energy would mean it operated at high voltage with a small amount of charge⁽¹⁹⁾.

The coil, then, would be set into oscillation at its resonant frequency by an external power source. During a portion of its cycle the coil will appear to the earth's electric field as one plate of a capacitor. As the voltage across the coil increases, the amount of charge it can "sink" from the earth's higher energy field will increase.

The energy taken into the coil - through the "small opening" which appears to be the atomic structure of the conductor according to the physics of Tesla's time - is "condensed" into positive and negative components of current, a lower energy state relative to the originating field.

The current is equivalent to the water converted to gases in Tesla's description of the self-acting engine. The current would "escape" from the "sink" into whatever load was connected across the coil. The movement of current into the load would produce a strong magnetic field (the stated intention of the patent) which, when it collapsed, would, again, produce a high potential, low charge "sink" to couple with the earth's electric field.

Because the inflowing energy performs a double function similar to the unipolar generator, supplying current to the load and aiding the pumping function, the system's energy expenditure in moving charge is low, allowing the system to gain more energy from the medium than it expends in its operation. The coil needs no extra energy from an outside source to pump the energy it has extracted.

Energy would come directly from the sun.

A more modern view of such a device, should it prove to operate in this theoretical manner, would be to describe it as a self-oscillating capacitive system. Once the device is set into oscillation, very little power is expended in driving the load. Because it is an electrostatic oscillating system, only a small amount of charge moves through the load per cycle, that is, the coulomb per seconds = amps are low. If the charge is used at a low rate, the energy stored in the capacitive system will be turned into heat at a slow rate enabling the oscillations to continue for a long period of time.

With his prominent position in the world of science at the time, it is curious why Tesla's invention was not commercialized or at least publicized more. Economics, not science, appear to have been the main factor. The adoption of alternating current was opposed by powerful financiers of the period. Michael Pupin, another leading electrical researcher at the turn of the century, noted in his autobiography:

...captains of industry...were afraid that they would have to scrap some of their direct current apparatus and the plants for manufacturing it, if the alternating current system received any support ... ignorance and false notions prevailed in the early nineties, because the captains of industry paid small attention to highly trained scientists (20) (21).

Tesla's patents for electrical generators and motors were granted in the late 1880's. During the 1890's the large electric power industry, in the form of Westinghouse and General Electric, came into being. With tens of millions of dollars invested in plants and equipment, the industry was not about to abandon a very profitable ten year old technology for yet another new one.

Tesla saw that profits could be made from the self-acting generator, but somewhere along the line he had pointed out to him the negative impact the device would have. At the end of the section in *Century* where he described his new generator he wrote:

I worked for a long time fully convinced that the practical realization of the method of obtaining energy from the sun would be of incalculable industrial value, but the continued study of the subject revealed the fact that while it will be commercially profitable if my expectations are well founded, it will not be so to an extraordinary degree(22) .

Years later, in 1933, he was more pointed in his remarks about the introduction of his fuelless generator. In the Philadelphia *Public Ledger* of November 2nd, is an interview with Tesla under the headline "Tesla 'Harnesses' Cosmic Energy." In it he was "Asked whether the sudden introduction of his principle would upset the present economic system, Dr. Tesla replied, 'It is badly upset already.' He added that now as never before was the time ripe for the development of new resources."

It has been nearly a century since Nikola Tesla claimed a radically new method for producing electricity. The need for the development of new resources is greater now than at the end of the last century. Perhaps these overlooked inventions will make his vision of "increasing human

energy through the use of the sun's energy" become a reality.

Acknowledgment

Thanks to Mr. John Ratzlaff of Millbrae, California for generously sharing a variety of Tesla material that helped make this paper possible.

References

1. Nikola Tesla, U.S. Patent #685,957, "Apparatus for the Utilization of Radiant Energy," reproduced in *Nikola Tesla: Lectures * Patents * Articles* (hereafter *LPA*), Tesla Museum, Beograd, 1956, reprinted by Health Research, Mokelumne Hill, CA., p. P-344, 1973.
2. Nikola Tesla, "The Problem of Increasing Human Energy - Through Use of the Sun's Energy," *The Century Illustrated Magazine*, reprinted in *LPA*, p. A-140.
3. Reference 2, p. A-142.
4. Nikola Tesla, "Notes on a Unipolar Generator," *The Electrical Engineer*, N.Y., Sept. 2, 1891, reprinted in *LPA*, p. A-24.
5. Reference 4, p. A-26.
6. W.M. Elsasser, "The Earth as a Dynamo," *Scientific American*, p. 44-48, May 1958.
7. Reference 4, p. A-23.
8. Reference 2, p. A-140.
9. Reference 2, p. A-141.
10. Reference 2, p. A-141.
11. Reference 2, p. A-141.
12. Reference 2, p. A-142.
13. Reference 2, p. A-142.
14. Nikola Tesla, U.S. Patent #512,340, "Coil for Electro-Magnets," reprinted in *LPA*, pp. P-428-429. He explains that a standard coil of 1000 turns with a potential of 100 volts across it will have a difference of .1 volt between turns. A similar bifilar coil will have a potential of 50 volts between turns. In that the stored energy is a function of the square of the voltages the energy in the bifilar will be $50^2/.1^2 = 2500/.01 = 250,000$ times greater than the standard coil.

15. Measurements were made by M. King and O. Nichelson at Eyring, Inc., with a HP 3577A network analyzer on 3 inch diameter coils with 43 turns each of number 20 wire.
16. Reference 2, p. A-143.
17. Carl Linde, "Process and Apparatus for Attaining Lowest Temperatures for Liquefying Gases, and for Mechanically Separating Gas Mixtures," *The Engineer*, pp. 485-6, Nov. 13, 1896 and p. 509, Nov. 20, 1896.
18. "The Amateur Scientist," *Scientific American*, p. 160, May 1957.
19. This resembles the electrostatic oscillator in Tesla's wireless transmission system: Oliver Nichelson, "The Underwater Communication System of Nikola Tesla," 1991.
20. Michael Pupin, *From Immigrant to Inventor*, Charles Scribner's Sons, N.Y., pp. 285-286, 1930.
21. Reference 2, p. A-143.
22. For others who followed Tesla with inventions to extract energy from the ambient medium see: Christopher Bird and Oliver Nichelson, "Nikola Tesla: Great Scientist, Forgotten Genius," *New Age*, p. 36 ff, Feb. 1977.

Return to [Table of Contents](#)

E-mail: onichelson@post.harvard.edu

E-mail: frank@germano.com

[[INDEX](#)]



Physics of the Fuelless Generator

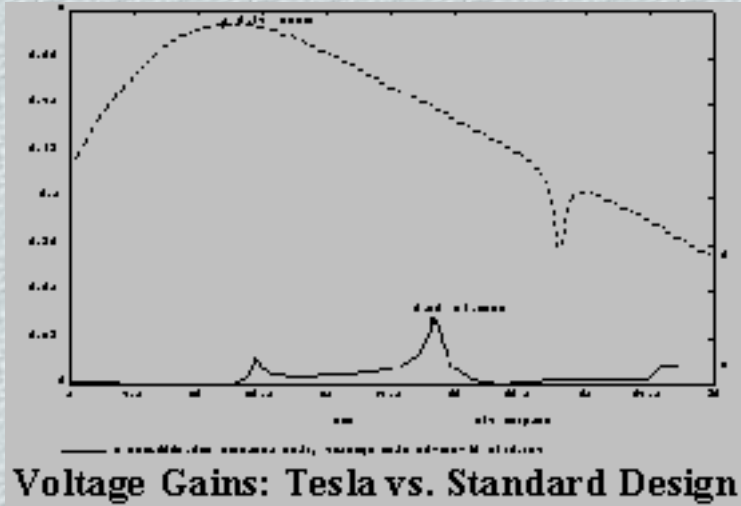

This paper argues that Tesla's fuelless generator follows the Second Law of Thermodynamics, that it is not an "over unity" device putting out more energy that it takes in. It is a device that performs little physical work and expends little of its stored energy.

Return to [Table of Contents](#)

The Second Law Thermodynamics and Tesla's Fuelless Generator

Oliver Nichelson
333 North 760 East
American Fork, Utah 84003 U.S.A.
© Copyright 1993

During an address commemorating the installation of his electrical generators at Niagara Falls , Nikola Tesla told his listeners:

We have to evolve means for obtaining energy from stores which are forever inexhaustible, to perfect methods which do not imply consumption and waste of any material whatever. I now feel sure that the realization of that idea is not far off. ...the possibilities of the development I refer to, namely, that of the operation of engines on any point of the earth by the energy of the medium...([Tesla, 1897](#))

In 1902, Tesla wrote to his friend and publisher Robert Underwood Johnson that he had already developed a device for using the energy of the surrounding medium to generate electricity ([Nichelson, 1993](#)). In the letter he stated that the design principles for this new type of generator were discussed in his June 1900 *Century Magazine* article ([Tesla, 1902](#)) on page 200, "particularly where I refer to novel facts."

An Energy Sink

His reference is to the article "The Problem of Increasing Human Energy - Through the Use of the Sun's Energy" ([Tesla, 1900](#)). The "novel facts" are mentioned in a section entitled "Energy from the Medium." It is in this and in the following section where the theoretical and developmental discussions of this new generator take place. Tesla uses two versions of simple graphic image to explain how such an energy extracting generator would work.

In the first example he asks that we consider a closed cylinder

such that energy could not be transferred across it except through a channel or path *O*... and ... that, by some means or other, in this inclosure a medium were maintained which would have little energy, and that on the outer side of the same there would be the ordinary ambient medium with much energy.

Tesla continues:

Under these assumptions the energy would flow through the path *O*, as indicated by the arrow, and might then be converted on its passage into some other form of energy.

Could we produce artificially such a "sink" for the energy of the ambient medium to flow in [and]... be enabled to get at any point of the globe a continuous supply of energy, day and night ([Tesla, 1900](#)).

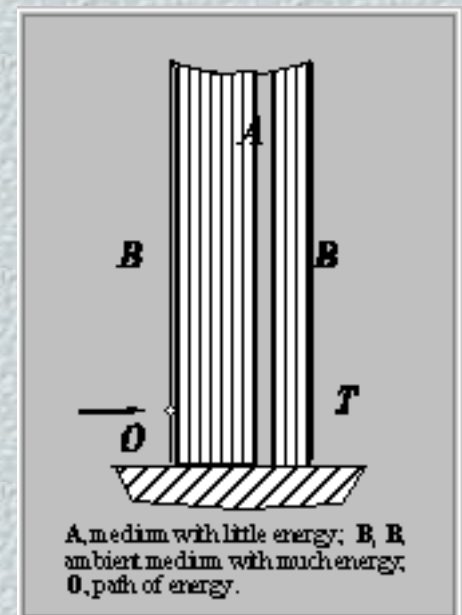

1. Ambient Medium Energy

In the next paragraph Tesla gives another version of how this energy extraction process would take place. He asks if we can produce cold in a given portion of space and cause the heat to flow in continually. Creating such a "cold hole" in the medium would be like creating in a lake either an empty space or a space filled with something much lighter than water.

This we could do by placing in the lake a tank, and pumping all the water out of the

latter. We know, then, that the water if allowed to flow back into the tank, would, theoretically, be able to perform exactly the same amount of work which was used in pumping it out, but not a bit more. ([Tesla, 1900](#))

He notes that in such an operation, nothing would be gained by pumping the water out and letting it fall back down the tank. It would be impossible, in this case, to create a sink in the medium.

Tesla, then, asks that we "reflect a moment" and adds:

Heat, though following certain general laws of mechanics, like a fluid, is not such; it is energy which may be converted into other forms of energy as it passes from a high to low level...assume that the water, in its passage into the tank, is converted into something else, which may be taken out of it without using any, or very little, power. For example, if heat [is represented] by the water of the lake, the oxygen and hydrogen composing the water may illustrate other forms of energy into which the heat is transformed in passing from hot to cold.

Corresponding to this ideal case, all the water flowing into the tank would be decomposed into oxygen and hydrogen before reaching the bottom ([Tesla, 1900](#)), and the result would be that water would continually flow in, and yet the tank would remain entirely empty, the gases formed escaping. We would thus produce, by expending initially a certain amount of work to create a sink for the heat or, respectively, the water to flow into, a condition enabling us to get any amount of energy without further effort.

Second Law of Thermodynamics

Understanding the operation of Tesla's new generator is a two part task - picturing it as he did in terms of 19th century science and explaining it in terms of today's science. Fortunately, he framed his explanation within the context of the Second Law of Thermodynamics as it was being formulated by the leading physical theorists of the day.

Rudolph Clausius put it, in 1850: "It is impossible for a self-acting machine unaided by an external agency to convert heat from one body to another at higher temperature." As given by Kelvin, "It is impossible by means of inanimate material agency to derive mechanical effect from any portion of matter by cooling it below the temperature of surrounding objects." If a machine was able, by itself, to take heat energy out of the surrounding environment and use that energy to run its cooling work, it would be a perpetual motion machine. Cooling the surrounding medium requires energy from an external source.

In his *Century Magazine* article, Tesla takes up the thermodynamics question in a section entitled "Possibility of a Self-Acting Engine...Inanimate, yet Capable of Deriving Energy from the Medium." He challenges the assertion about the impossibility of a cooling machine's ability to

operate from the heat derived from the medium with a simple thought experiment.

If two metal rods ran from the earth to outer space, the temperature difference between the ends of the rods would create an electric current in the rods which could operate an electric motor. This would be a device that would cool the medium and do work from the heat of the medium.

With this example, Tesla does not refute the Second Law of Thermodynamics but shows the limits of its popular understanding. He does not deny the most basic tenant that energy flows from hot to cold, from a high energy state to a lower state. What he asserts is that good engineering can cause work to be done in the change from a higher to lower energy state without creating a perpetual motion machine.

Ambient Medium

How an energy sink can be created on earth requires two additional pieces of information presupposed by Tesla's thermodynamics discussion - the nature of the fluid that makes up the ambient medium and what constitutes a low temperature in this medium.

To understand the concept of the energy of the ambient medium, it is necessary to return to the historical roots of electrical science. From the time of Franklin until the beginning of this century, electricity was pictured as a fluid that flowed through conductors and, like steam that powered the engines of the day, could be condensed out the medium. The capacitors of today were once known as condensers due to this concept.

Before the last paradigm shift at which the universe came to be viewed as atomic particles moving randomly in a void, physics believed all matter was made from a primary substance. It was this primary material, the aether ([Dunlap, 1934](#)) of Maxwell and Kelvin, that filled the ambient medium.

As for temperature, Tesla wrote ([Tesla, Feb. 1919](#)) that "in light of present knowledge we may liken electric potential to temperature." Creating a low temperature region in the high energy ambient medium meant creating a sustained low electrical potential. Relative to the medium, the device creating this low pressure region could be seen as a self-cooling apparatus.

In principle, the electrical fluid would enter the device, transform into a lower form of energy and perform work as the fluid continued to flow into the device. The nature of this transformation is conjecture at this point, but it seems that the electrical fluid was seen to be transformed into positive and negative potential.

Thermodynamic Work

In accordance with the Second Law of Thermodynamics, Tesla's device would make use of energy moving from a higher temperature to a lower temperature, but would be self-sustaining, or self-cooling by converting the energy coming from the environment into a different form in a process that consumed only a small amount of the incoming energy.

This last element in the operation of the device - that it consume very little of the working energy - is mentioned ([Tesla, Feb. 1919](#)) in connection with his wireless receiver. He wrote that "energy will be economically transmitted and very little power consumed as long as no work is done in the receiver." Here "work" is meant in the technical sense - power expended over time.

The Tesla device for extracting energy from the ambient medium, then, operated by transforming the input energy into potential and doing no or little work in the device itself. Electrical energy, the units of work, is measured in watt-secs or amperes x volts x secs. Volts and amperes are the quantities of the electrical fluid and because potential is enhanced, the conclusion is that work, or energy, is conserved by reducing conduction current in the device. The new generator appears to have operated by potential variations and with no or very little current. It seems to have been an electrostatic device.

Because the receiver in the Tesla wireless system and new energy generator share the characteristic of using no, "or very little, power," it is useful to examine how the receiver was pictured to have operated. In 1919, Tesla detailed his wireless method in the *Electrical Experimenter*, using hydraulic analogies.

A conventional electrical transmission system requiring two wires is equated to a hydraulic system with a reciprocating piston, Fig. 2. The working fluid is pushed and pulled "with high velocity thru the small channel" so "that virtually all the energy of movement would be transformed into heat by friction, similarly to that of the electric current in the lamp filament."

On the other hand, the wireless method is like the one-wire transmission system Tesla demonstrated several times, Fig. 3. A reciprocating cylinder pushes the working fluid through the friction device and into a large elastic reservoir. When the piston has reached the end of its stroke, the elastic reservoir is filled with the working fluid and sends it back through the friction device...the fluid is made to surge thru the restricted passage with great speed, this resulting in the generation of heat as in the incandescent lamp. Theoretically considered, the efficiency of conversion of energy should be the same in both cases. Tesla seems to be saying that for a light bulb of a given wattage, it can be powered either by a commercial power

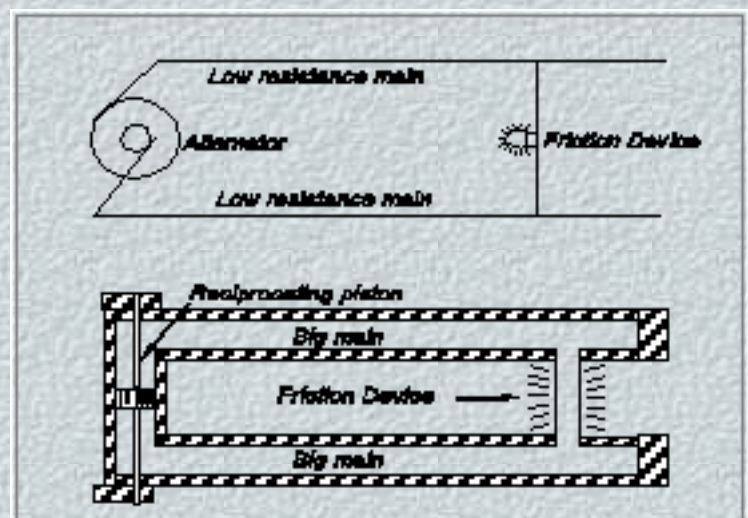

2. Electric Transmission Thru Two Wires and Hydraulic Analog

source of a certain voltage and amperage, or by a single wire of much smaller amperage but much greater voltage. For example, a 100 watt light bulb could be powered by 100 volts and 1 ampere

or by 1000 volts and .1 ampere.

For an electrical device to do no work, this arrangement has to be taken another step. Work consists of a force moving something over a period of time. In the case of electricity this is a voltage pushing a charge carrier through a cross sectional area of a conductor. The number of coulombs of charge passing a certain point in a conductor in a second constitutes a current, $q/s=i$. Doing no electrical work means the number of charge carriers passing a point in the conductor has to approach zero.

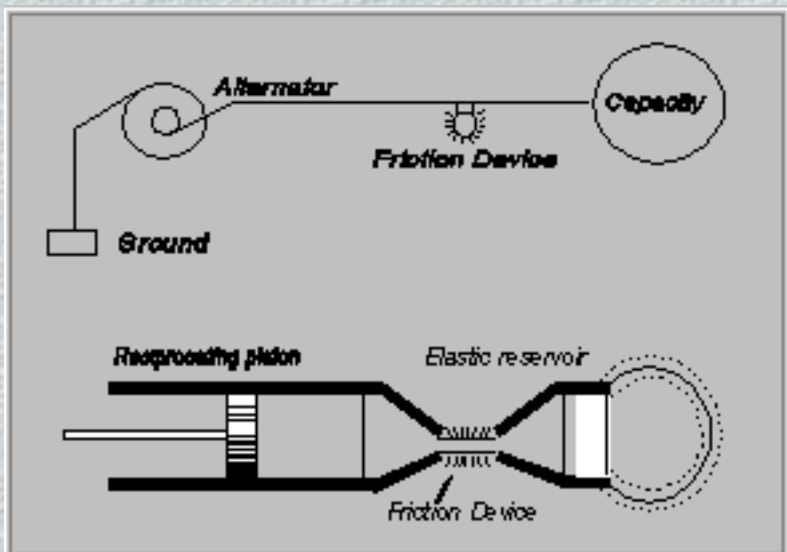

3. Electric Transmission Thru a Single Wire
Hydraulic Analog

Displacement Current

The condition in which an alternating current can be maintained with no translational movement of charge carriers is found in a capacitor. A displacement current consists of the back and forth movement of bound charges within the lattice structure of a non-conducting dielectric material.

No work would be done if the device operated with a displacement current. If a large voltage displaced a small amount of bound charge, the power requirements of a load, like a light bulb, would be met with no conduction current, therefore, with no expenditure of energy.

Tesla's thermodynamic argument with the rods-reaching-into-space thought experiment is that energy differences in the environment can be used to power a device that extracts that energy without being a perpetual motion machine. With his new energy extraction device, his argument is that energy can be taken from the environment, and, if converted to pure potential, can power a load while doing no work within the device. In the first example the long rods will allow a motor to operate until the earth has the same temperature as outer space. In the second instance, he describes a device that incorporates an energy difference within itself and expends no, or very little of that energy in powering a load. Though the second device may appear outwardly to be a perpetual motion machine, it does, as he shows, follow the Second Law of Thermodynamics.

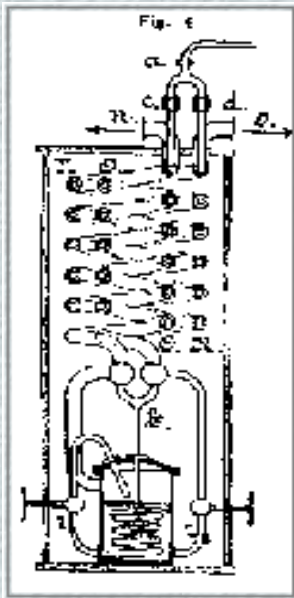

Tesla's comparison (Tesla, 1900) of his self cooling energy extractor with Carl Linde's double coiled apparatus for liquefying air, Figure 4, points to his double wound coil (Tesla, 1894) design, Fig. 5, as one likely embodiment (Nichelson, 1991) of his energy extraction device.

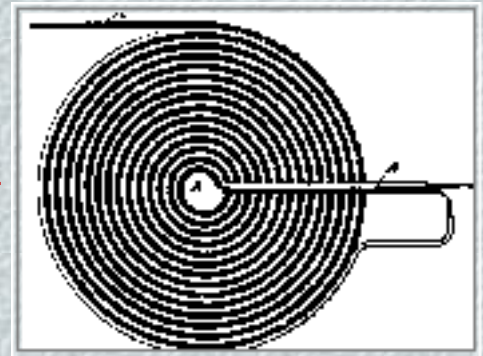

5. Coil for Electro-Magnets

Measurements (Nichelson, 1991) of the same size single and double wound coils, both with approximately the same inductance have shown that, at resonance, both the voltage response and voltage gain to be several orders of magnitude greater for the double wound design . The figure below shows the voltage gain of two 4 inch diameter helix wound coils with the same number of turns. The lower plot is of the single wound coil and the upper curve is that of the double wound coil.

7. Linde's condenser

Assuming this bifilar coil is related to Tesla's design for a new energy device, it can be theorized that it would be driven at a voltage as great as could be tolerated by the wire's insulation and that the amount of stored charge would be at least as great as required by the load at the operating voltage and frequency. To take a purely hypothetical example, if the load is a 100 watt light bulb and the potential in the coil is 5000 volts and the coil is oscillating at a frequency of 1000 Hz, then in a period of a quarter cycle a charge of 5×10^{-6} coulombs would have to be displaced.

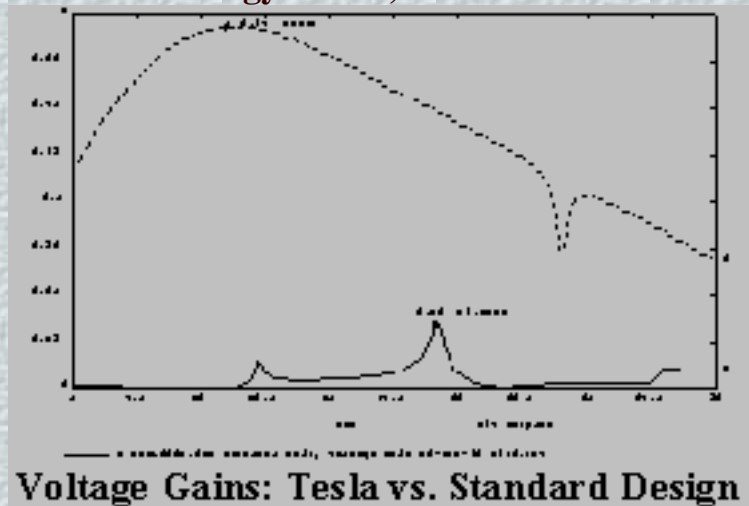

$$100 \text{ watts} / 5000 \text{ volts} = .02 \text{ amperes}$$

$$\text{and } 1/4 \times 1000 \text{ Hz} = 2.5 \times 10^{-4} \text{ s}$$

$$\therefore q = i \times s = .02 \times 2.5 \times 10^{-4} \\ = 5 \times 10^{-6} \text{ coulombs}$$

This would give a system capacitance of

$$C = q / v = 5 \times 10^{-6} / 5000 = .001 \mu$$

Like the equations of Maxwell and the AC motor of Tesla, both conceived within the context of 19th century aether based physics and are still used after the physics has been discarded, the new energy device does not require belief in an energetic ambient medium. The concept served only to explain the source of electricity to earlier researchers who naively sought an answer to this fundamental question. Modern engineering practice does not require a primary source of electricity be given, but only a description of how it operates or makes a device operate.

Tesla's new "generator" can be explained solely on the basis of its electrical activity. A bifilar coil is capable of holding more charge than a single wound coil. When operated at resonance, the distributed capacitance of the bifilar coil is able to overcome the counter force normal to coils, inductive reactance. It does not allow what Tesla described ([Tesla, 1894](#)) as the formation of "false currents."

Because the electrical activity in the coil does not work against itself in the form of a counter-emf, the potential across the coil quickly builds to a high value. The difference between the turns becomes great enough that ([Tesla, 1892](#)) "the energy would be practically all potential." At this point, the system becomes an electrostatic oscillator.

Minimal work is done in the system due to absence of translational movement in the displacement current. As small heat losses occur, oscillations are maintained by the surplus charge stored in the coil. Very low energy expenditure allows power delivery to a load over an extended time period without an external fuel supply. After an initial input of energy from an outside source, Tesla's new electrical generator would operate as a fuelless device.

References

Dunlap, Orrin E., Jr., "Tesla Sees Evidence That Radio and Light Are Sound," *N.Y. Times*, X, p. 9, April 8, 1934.

Linde, Carl, "Process and Apparatus for Attaining Lowest Temperatures, for Liquefying Gases, and for Mechanically Separating Gas Mixtures," *The Engineer*, p. 509, Nov. 20, 1896.

Nichelson, Oliver, "Nikola Tesla's Later Energy Designs," IECEC, 26th Proceedings, Am. Nuclear Society, Vol. 4, pp. 439-444, 1991.

Nichelson, Oliver, "Nikola Tesla's 'Free Energy' Documents," American Fork, Utah, 1993.

Tesla, Nikola, "Experiments with Alternate Currents of High Potential and High Frequency," IEE, London, Feb. 1892, reproduced in *Nikola Tesla: Lectures * Patents * Articles (hereafter, LPA)*,

published by the Nikola Tesla Museum, Nolit, Beograd, 1956, p. L-105.

Tesla, Nikola, "Coil for Electro-Magnets," U.S. Patent #512,340, Jan. 9, 1894.

Tesla, Nikola, "On Electricity," *Electrical Review*, Jan 27, 1897, in *LPA*, p. A-107.

Tesla, Nikola, Letter to R.U. Johnson, 1902, in the Nikola Tesla Collection, Rare Book and Manuscript Library, Columbia University, New York City. Page 200 of the magazine corresponds to pages A-138 and 139 in *LPA*.

Tesla, Nikola, "The Problem of Increasing Human Energy, *Century Magazine*, June 1900, in *LPA*, pp. A-109 to A-152.

Tesla, Nikola, "Famous Scientific Illusions," *Electrical Experimenter*, Gernsback Publications, Feb. 1919, pp. 692-694 ff.

Tesla, Nikola, "The True Wireless," *Electrical Experimenter*, Gernsback Publications, May 1919, pp. 28-30 ff.

Return to [Table of Contents](#)

E-mail: onichelson@post.harvard.edu

amazon.com
and you're done.™

Shop
Now &
Save

[Click here](#)

[Privacy Information](#)

- [Electronics](#)
- [Books](#)
- [Music](#)
- [DVD](#)
- [Video](#)
- [Toys & Games](#)
- [Today's Deals](#)
- [Kitchen & Housewares](#)
- [Tools & Hardware](#)
- [Computer & Video Games](#)
- [Outdoor Living](#)
- [Apparel & Accessories](#)
- [Camera & Photo](#)
- [More...](#)

[[INDEX](#)]



Tesla Wireless and the Tunguska Explosion



Tesla's writings have many references to the use of his wireless power transmission technology as a directed energy weapon. These references are examined in their relationship to the Tunguska explosion of 1908 which may have been a test firing of Tesla's energy weapon.

This article was first published in a different form in 1990. The idea of a Tesla directed energy weapon causing the Tunguska explosion was incorporated in a fictional biography (1994), by another writer, and was the subject of a *Sightings* television program segment.

Return to [Table of Contents](#)

Tesla's Wireless Power Transmitter and the Tunguska Explosion of 1908

Oliver Nichelson
333 North 760 East
American Fork, Utah 84003
© Copyright 1995

The French ship *Iena* blew up in 1907. Electrical experts were sought by the press for an explanation. Many thought the explosion was caused by an electrical spark and the discussion was about the origin of the ignition. Lee De Forest, inventor of the Audion vacuum tube adopted by many radio broadcasters, pointed out that Nikola Tesla had experimented with a "dirigible torpedo" capable of delivering such destructive power to a ship through remote control. He noted, though, Tesla also claimed that the same technology used for remotely controlling vehicles also could project an electrical wave of "sufficient intensity to cause a spark in a ship's magazine and

explode it." [\(1\)](#)

In the summer of 1913, Signor Giulio Ulivi, blew up a gas meter with his "F-Ray" device and destroyed his laboratory. Then, in August of that year, exploded three mines in the port of Trouville for a number of high ranking French naval officers. The following November, he travelled to Splezzia, Italy to repeat the experiments on several old ships and torpedo boats for that country's navy.[\(2\)](#)

In the Spring of 1924 newspapers carried several stories about "death rays" inventions in different parts of the world. The work of Harry Grindell-Matthews, London, was the first reported. The *New York Times* of May 21st had this one:

Paris, May 20 - If confidence of Grindell Matthews, inventor of the so-called ' diabolical ray,' in his discovery is justified it may become possible to put the whole of an enemy army out of action, destroy any force of airplanes attacking a city or paralyze any fleet venturing within a certain distance of the coast by invisible rays. So much the inventor consented to tell The New York Times correspondent today while continuing to refuse to divulge the exact nature of the rays beyond that they are used to direct an electric current able to perform the program just mentioned.[\(3\)](#)

Grindell-Matthews stated that his destructive rays would operate over a distance of four miles and that the maximum distance for this type of weapon would be seven or eight miles. Asked if it would be possible to destroy an approaching enemy fleet, the inventor said it would not, because "Ships, like land, are in continual contact with the earth, but what I can do is to put the ships out of action by the destruction of vital parts of the machinery, and also by putting the crews temporarily out of action through shock."[\(4\)](#) Airplanes, on the other hand, could be completely destroyed. As soon as his ray touched the plane it would burst into flames and fall to earth.

Grindell-Matthews asserted, "I am convinced the Germans possess the ray." He believed, though, they were carrying out their experiments with high frequencies and at high power, around 200 kilowatts, and could not control the weapon to hit a specific target. So far, said Grindell-Matthews, he had tried tests at 500 watts in his laboratory over a distance of sixty-four feet.

A French company, the Great Rhone Engineering Works of Lyon, had offered Grindell-Matthews extensive financial backing that would allow him to test his device at much higher power levels. He replied that would not undertake such tests "except under conditions of absolute safety on a wide tract of uninhabited land," such was the destructive power of his rays.

Details of the "diabolical rays'" destructive power surfaced that August. "Tests have been reported where the ray has been used to stop the operation of automobiles by arresting the action of the magnetos, and an quantity of gunpowder is said to have been exploded by playing the beams on it from a distance of thirty-six feet."[\(5\)](#) Grindell-Matthews was able, also, to electrocute mice,

shrivel plants, and light the wick of an oil lamp from the same distance away.⁽⁶⁾

His own laboratory assistants were themselves became unintentional victims of the ray. When crossing its path during tests they were either knocked unconscious by violent electrical shocks or received intense burns. The inventor stated that though it would be possible to kill enemy infantry with the ray, "it would be quite easy to graduate the electric power used so that hostile troops would only be knocked out long enough to effect their capture."⁽⁷⁾

On May 25th, a second death ray was announced in England. Doctor T.F. Wall, a "lecturer in electrical research in Sheffield University, "applied for a patent for means of transmitting electrical energy in any direction without the use of wires. According to one report. even though he has not made tests on a large scale yet "Dr. Wall expressed the belief that his invention would be capable of destroying life, stopping airplanes in flight and bringing motor cars to a standstill." On a more positive note, he added that his invention would have beneficial applications in surgical and medical operations.⁽⁸⁾

Germany joined the technology race on May 25th when it announced its electrical weapon. As the *Chicago Tribune* reported:

Berlin - That the German Government has an invention of death rays that will bring down airplanes, halt tanks on the battlefields, ruin automobile motors, and spread a curtain of death like the gas clouds of the recent war was the information given to Reichstag members by Herr Wulle, chief of the militarists in that body. It is learned that three inventions have been perfected in Germany for the same purpose and have been patented.

Sensing something of importance the *New York Times* copyrighted its story of May 28th on a ray weapon developed by the Soviets. The story opened: "News has leaked out from the Communist circles in Moscow that behind Trotsky's recent war-like utterance lies an electromagnetic invention, by a Russian engineer named Grammachikoff for destroying airplanes."⁽⁹⁾

Tests of the destructive ray, the *Times* continued, had began the previous August with the aid of German technical experts. A large scale demonstration at Podosinsky Aerodome near Moscow was so successful that the revolutionary Military Council and the Political Bureau decided to fund enough electronic anti-aircraft stations to protect sensitive areas of Russia. Similar, but more powerful, stations were to be constructed to disable the electrical mechanisms of warships. The Commander of the Soviet Air Services, Rosenholtz, was so overwhelmed by the ray weapon demonstration that he proposed "to curtail the activity of the air fleet, because the invention rendered a large air fleet unnecessary for the purpose of defense."

An English engineer, J.H. Hamil, offered the American army plans for producing " an invisible ray capable of stopping airplanes and automobiles in midflight," invented by a German scientist.

The ray device was said to have been used the previous summer to bring down French planes over Bavaria. Hamil noted, however, that "the fundamental work was done by Nikola Tesla in Colorado Springs about 30 years ago. He built a powerful electrical coil. It was found that the dynamos and other electrical apparatus of a Colorado fuel company within a 100 yards or so were all put out of business."⁽¹⁰⁾

Hamil believed the Tesla coil scattered rays which short-circuited electrical machinery at close range. Laboratories all over the world, he added, were testing methods of stepping up the Tesla coil to produce its effects at greater distances. "Working on an entirely different principle," Hamil said, "the German scientist has succeeded in projecting and directing electrical power."

Those Colorado Springs tests carried out by Tesla were well remembered by local residents. With a 200 foot pole topped by a large copper sphere rising above his laboratory he generated potentials that discharged lightning bolts up to 135 feet long. Thunder from the released energy could be heard 15 miles away in Cripple Creek. People walking along the streets were amazed to see sparks jumping between their feet and the ground, and flames of electricity would spring from a tap when anyone turned them on for a drink of water. Light bulbs within 100 feet of the experimental tower glowed when they were turned off. Horses at the livery stable received shocks through their metal shoes and bolted from the stalls. Even insects were affected: Butterflies became electrified and "helplessly swirled in circles - their wings spouting blue halos of 'St. Elmo's Fire.'"⁽¹¹⁾

The effect that captured the attention of foreign death ray inventors occurred at the Colorado Springs Electric Company powerhouse. One day while Tesla was conducting a high power test, the crackling from inside the laboratory suddenly stopped. Bursting into the lab Tesla demanded to know why his assistant had disconnected the coil. The assistant protested that had not done anything. The power from the city's generator, the assistant said, must have quit. When the angry Tesla telephoned the power company he received an equally angry reply that the power company had not cut the power, but that Tesla's experiment had destroyed the generator!

The inventor explained to *The Electrical Experimenter*, in August of 1917 what had happened.

As an example of what has been done with several hundred kilowatts of high frequency energy liberated, it was found that the dynamos in a power house six miles away were repeatedly burned out, due to the powerful high frequency currents set up in them, and which caused heavy sparks to jump thru the windings and destroy the insulation! The lightning arresters in the power house showed a stream of blue-white sparks passing between the metal plates to the earth connection."⁽¹²⁾

When questioned about the Ulivi ray that created so much comment a few years earlier, Tesla asserted, in the same interview, that "it was transplanted from this country to Italy." He saw it as simply a modification of his ultra-powerful high frequency coil tested in Colorado. With thousands of horsepower⁽¹³⁾ of energy "it would become readily possible to detonate powder and

munition magazines by means of the high frequency currents induced in every bit of metal, even when located five to six miles away or more."

With others attributing an energy weapons technology to Tesla's wireless power transmission research, his comments on the destructive capabilities of his system take on a great deal of importance. Writing tersely for *Liberty* magazine of February 1935 he stated:

My invention requires a large plant, but once it is established it will be possible to destroy anything, men or machines, approaching within a radius of 200 miles. It will, so to speak, provide a wall of power offering an insuperable obstacle against any effective aggression.⁽¹⁴⁾

He went on to make a distinction between his invention and those brought forward by others. He claimed that his device did not use any so-called "death rays" because such radiation cannot be produced in large amounts and rapidly become weaker over distance. He likely was making reference to a Grindell-Matthews type of device that, according to contemporary reports, used a powerful ultra-violet beam to make the air conducting so that high energy current could be directed to the target. The range of an ultra-violet searchlight would be much less than what Tesla was claiming. As he put it: "all the energy of New York City (approximately two million horsepower [1.5 billion watts]) transformed into rays and projected twenty miles, would not kill a human being."

Not wanting to give away a potentially valuable creation in an interview, he was intentionally opaque concerning the details of his design. He did clarify how his design differed from the ray type of devices.

My apparatus projects particles which may be relatively large or of microscopic dimensions, enabling us to convey to a small area at a great distance trillions of times more energy than is possible with rays of any kind. Many thousands of horsepower can be thus transmitted by a stream thinner than a hair, so that nothing can resist.

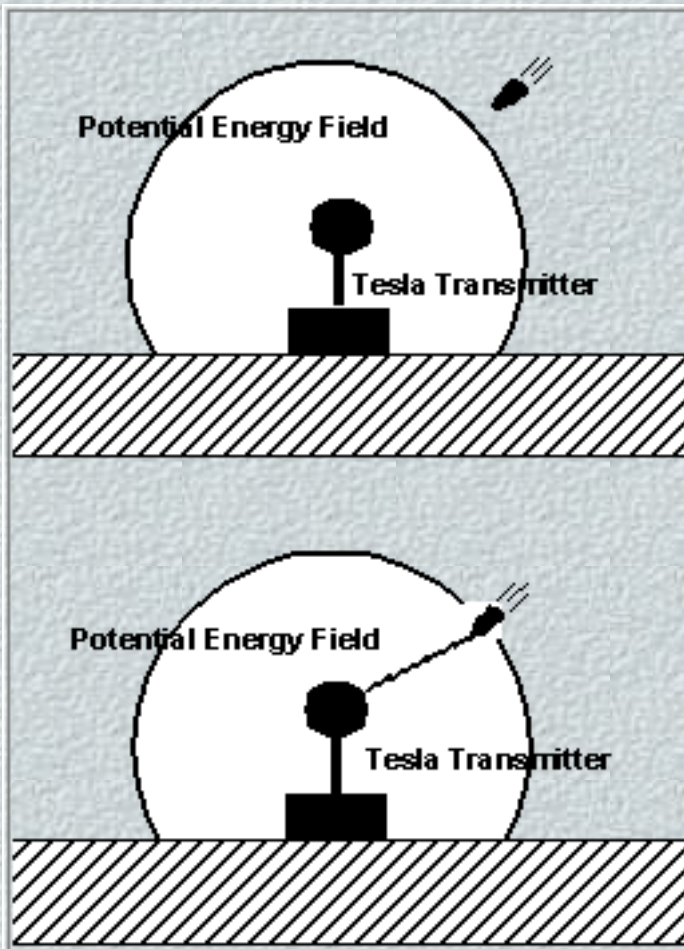

Tesla particle beam system - possible configuration

If Tesla's energy weapon cannot be called a "ray" device, but as one projecting microscopic particles, it would seem that it had to differ from the other designs in one of two ways. Either he was making the distinction between a beam of radiant energy, like a beam from a flashlight that has billions of energy carrying photons, and his own with all of its energy concentrated into a stream a single particle wide, or he was making a distinction about the size of the beam and the method it is used to reach the target.

In a Grindell-Matthews type of beam, the flashlight model, a huge number of high energy particles or photons would have to be sent out from the system so that a large enough area on the target would be covered to disable it. What Tesla seems to have intended was that his energy transmitter would set up a field of force around itself which, when penetrated, would release its energy directly to the target. The effect would be like sending a current of particles through a wire directly to the target. A large area on the target would not have to be "painted" by a beam, so the current reaching the intruder could be very thin and deliver a great deal of energy to a small area.

The Colorado tests that gave rise to the variety of "death ray" inventions in the U.S. and Europe may have lead to the development of a much more powerful weapon.

When Tesla realized that economic forces would not allow the development of a new type of electrical generator that would supply power without burning fuel he "was led to recognize [that] the transmission of electrical energy to any distance through the media as by far the best solution of the great problem of harnessing the sun's energy for the use of man."^{(15),(16)} His idea was that a relatively few generating plants located near waterfalls would supply his very high energy transmitters which, in turn, would send power through the earth to be picked up wherever it was needed.

Receiving energy from this high pressure reservoir only would require a person to put a rod into the ground and connect it to a receiver operating in resonance with the electrical motion in the earth. As Tesla described in 1911, "The entire apparatus for lighting the average country dwelling will contain no moving parts whatever, and could be readily carried about in a small valise."⁽¹⁷⁾

The difference between a current used to "light the average country dwelling" and a current used

as a method of destruction, however, is a matter of timing. If the amount of electricity used to run a television for an hour is released in a millionth of a second, it would have a very different, and negative, effect on the television.

Tesla said his transmitter could produce 100 million volts of pressure and currents up to 1000 amperes, with experimental power levels of billion or tens of billions of watts.⁽¹⁸⁾ If that amount of power were released in "an incomparably small interval of time,"⁽¹⁹⁾ the energy would be equal to the explosion of millions of tons of TNT, that is, a multi-megaton explosion. Such a transmitter would be capable of projecting the force of a nuclear warhead by radio. Any location in the world could be vaporized at the speed of light.

Not unexpectedly, many scientists doubted the technical feasibility of Tesla's wireless power transmission scheme whether for commercial or military purposes. Modern authorities in electronics, even those who express admiration for the Tesla's genius, believe he was mistaken in the interpretation of his experiments when it came to electrical transmission through the earth.^{(20), (21), (22)}

On the other hand, statements from authoritative witnesses who saw Tesla's equipment in operation support his claim about transmission with something other than the radio waves known today. During the Chicago World's Fair of 1893, the Westinghouse exhibit set up by Tesla was visited by the Herman von Helmholtz, the first director of the Physico-Technical Institute of Berlin and one of the leading scientists of his time. When Tesla "asked the celebrated physicist for an expression of opinion on the feasibility of the [transmission] scheme. He stated unhesitatingly that it was practicable."⁽²³⁾ In 1897, Lord Kelvin visited New York and stopped at the Tesla laboratory where Tesla "entertained him with demonstrations in support of my wireless theory."

Suddenly [Kelvin] remarked with evident astonishment: 'Then you are not making use of Hertz waves?' 'Certainly not', I replied, '*these are radiations.*' ... I can never forget the magic change that came over the illustrious philosopher the moment he freed himself from that erroneous impression. The skeptic who would not believe was suddenly transformed into the warmest of supporters. He parted from me not only thoroly convinced of the scientific soundness of the idea but strongly exprest his confidence in its success.⁽²⁴⁾

A recent analysis of Tesla's wireless transmission method shows that he used an electrostatic transmission technique that did not radiate radio waves as we know them and could sent waves through the earth with little loss of power.⁽²⁵⁾ The question remains of whether Tesla demonstrated the weapons application of his power transmission system. Circumstantial evidence found in the chronology of Tesla's work and financial fortunes between 1900 and 1908 points to there having been a test of this weapon.

1900: Tesla returned to New York from Colorado Springs after completing the tests of wireless

power transmission that destroyed the power company's generator. He received \$150,000 from J. P. Morgan to build a transmitter to signal Europe. With the first portion of the money he obtained 200 acres of land at Shoreham, Long Island and built an 187 foot tall tower with a steel shaft running 120 feet into the ground. This tower was topped with a 55 ton, 68 foot diameter metal dome. He called the research site "Wardenclyffe" and envisioned 2000 people eventually working at his global communications center.

A stock offering is made by the Marconi company. Supporters of the Marconi Company include his old adversary Edison and one-time associate Michael Pupin. Investors rushed to buy the Marconi shares. On December 12th, Marconi sent the first transatlantic signal, the letter "S," from Cornwall, England to Newfoundland, Canada. He did this with, as the financiers noted, equipment much less costly than that being built by Tesla.

1902: The Wardenclyffe transmitter nears completion. Marconi is hailed as a hero around the world while Tesla is seen as a shirker by the public for ignoring a call to jury duty in a murder case (he was excused from duty because of his opposition to the death penalty).

1903: When Morgan sent the balance of the \$150,000, it would not cover the outstanding balance Tesla owed on the Wardenclyffe construction. To encourage a larger investment in the face of Marconi's success, Tesla revealed to Morgan his real purpose was not to just send radio signals but the wireless transmission of power to any point on the planet. Morgan was uninterested and declined to provide further funding.

A financial panic that Fall put an end to Tesla's hopes for financing by Morgan or other wealthy industrialists. This left Tesla without money even to buy the coal to fire the transmitter's electrical generators.

1904 - 1906: Tesla writes for the *Electrical World*, "The Transmission of Electrical Energy Without Wires," noting that the globe, even with its great size, responds to electrical currents like a small metal ball.

Tesla declares to the press the completion of Wardenclyffe. Marconi is hailed as a world hero.

Tesla subject to multiple law suits over unpaid Colorado Springs expenses. George Westinghouse, who bought Tesla's patents for alternating current motors and generators in the 1880's, turns down the inventor's power transmission business proposal. Workers gradually stop coming to the Wardenclyffe laboratory when there are no funds to pay them. In an article, Tesla comments on Peary's expedition to the North Pole and tells of his, Tesla's, plans for energy transmission to any central point on the ground.

1907: When commenting on the destruction of the French ship *Iena*, Tesla noted in a letter to the

New York Times that he has built and tested dirigible torpedoes (remotely controlled torpedoes), but that electrical waves would be more destructive. "As to projecting wave energy to any particular region of the globe ... this can be done by my devices," he wrote. Further, he claimed that "the spot at which the desired effect is to be produced can be calculated very closely, assuming the accepted terrestrial measurements to be correct."⁽²⁶⁾

1908: Tesla repeated the idea of destruction by electrical waves to the newspaper on April 21st. His letter to the editor stated, "When I spoke of future warfare I meant that it should be conducted by direct application of electrical waves without the use of aerial engines or other implements of destruction." He added: "This is not a dream. Even now wireless power plants could be constructed by which any region of the globe might be rendered uninhabitable without subjecting the population of other parts to serious danger or inconvenience."⁽²⁷⁾

In the period from 1900 to 1910 Tesla's creative thrust was to establish his plan for wireless transmission of energy. Undercut by Marconi's accomplishment, beset by financial problems, and spurned by the scientific establishment, Tesla was in a desperate situation by mid-decade. The strain became too great by 1906-1907 and, according to Tesla biographers, he suffered an emotional collapse.^{(28),(29)} In order to make a final effort to have his grand scheme recognized, he may have tried one high power test of his transmitter to show off its destructive potential. This would have been in 1908.

The Tunguska event took place on the morning of June 30th, 1908. An explosion estimated to be equivalent to 10-15 megatons of TNT flattened 500,000 acres of pine forest near the Stony Tunguska River in central Siberia. Whole herds of reindeer were destroyed. Several nomadic villages were reported to have vanished. The explosion was heard over a radius of 620 miles. When an expedition was made to the area in 1927 to find evidence of the meteorite presumed to have caused the blast, no impact crater was found. When the ground was drilled for pieces of nickel, iron, or stone, the main constituents of meteorites, none were found down to a depth of 118 feet.

Several explanations have been given for the Tunguska event. The officially accepted version is that a 100,000 ton fragment of Encke's Comet, composed mainly of dust and ice, entered the atmosphere at 62,000 mph, heated up, and exploded over the earth's surface creating a fireball and shock wave but no crater. Alternative explanations of the disaster include a renegade mini-black hole or an alien space ship crashing into the earth with the resulting release of energy.

Associating Tesla with the Tunguska event comes close to putting the inventor's power transmission idea in the same speculative category as ancient astronauts. However, historical facts point to the possibility that this event was caused by a test firing of Tesla's energy weapon.

In 1907 and 1908, Tesla wrote about the destructive effects of his energy transmitter. His Wardencllyffe facility was much larger than the Colorado Springs device that destroyed the power

station's generator. Then, in 1915, he stated bluntly:

It is perfectly practical to transmit electrical energy without wires and produce destructive effects at a distance. I have already constructed a wireless transmitter which makes this possible. ... But when unavoidable [it] may be used to destroy property and life. The art is already so far developed that the great destructive effects can be produced at any point on the globe, defined beforehand with great accuracy (emphasis added).⁽³⁰⁾ Nikola Tesla, 1915

He seems to confess to such a test having taken place before 1915, and, though the evidence is circumstantial, Tesla had the motive and the means to cause the Tunguska event. His transmitter could generate energy levels and frequencies capable of releasing the destructive force of 10 megatons, or more, of TNT. And the overlooked genius was desperate.

The nature of the Tunguska event, also, is consistent with what would happen during the sudden release of wireless power. No fiery object was reported in the skies at that time by professional or amateur astronomers as would be expected when a 200,000,000 pound object enters the atmosphere at tens of thousands miles an hour. Also, the first reporters, from the town of Tomsk, to reach the area judged the stories about a body falling from the sky was the result of the imagination of an impressionable people. He noted there was considerable noise coming from the explosion, but no stones fell. The absence of an impact crater can be explained by there having been no material body to impact. An explosion caused by broadcast power would not leave a crater.

In contrast to the ice comet collision theory, reports of upper atmosphere and magnetic disturbances coming from other parts of the world at the time of and just after the Tunguska event point to massive changes in earth's electrical condition. Baxter and Atkins cite in their study of the explosion, *The Fire Came By*, that the *Times* of London editorialized about "slight, but plainly marked, disturbances of ... magnets," which the writer, not knowing then of the explosion, associated with solar prominences.⁽³¹⁾

In Berlin, the *New York Times* of July 3rd reported unusual colors in the evening skies thought to be Northern Lights: "Remarkable lights were observed in the northern heavens ... bright diffused white and yellow illumination continuing through the night until it disappears at dawn."⁽³²⁾ Massive glowing "silvery clouds" covered Siberia and northern Europe. A scientist in Holland told of an "undulating mass" moving across the northwest horizon. It seemed to him not to be a cloud, but the "sky itself seemed to undulate." A woman north of London wrote the *London Times* that on midnight of July 1st the sky glowed so brightly it was possible to read large print inside her house. A meteorological observer in England recounted on the nights of June 30th and July 1st:

A strong orange yellow light became visible in the north and northeast... causing an

undue prolongation of twilight lasting to daybreak on July 1st...There was a complete absence of scintillation or flickering, and no tendency for the formation of streamers, or a luminous arch, characteristic of auroral phenomena...Twilight on both of these night was prolonged to daybreak, and there was no real darkness.⁽³³⁾

The report that most closely ties these strange cosmic happenings with Tesla's power transmission scheme is that while the sky was aglow with this eerie light it was possible to clearly see ships at sea for miles in the middle of the night.⁽³⁴⁾ Tesla specifically claimed this as one of the effects he could achieve with his high power transmitter. Of particular importance is that none of his claims for lighting the ocean appeared before 1908.⁽³⁵⁾

A typical statement about the light induced by his transmitter is this from the *New York American* of December 7th, 1914:

The lighting of the ocean ... is only one of the less important results to be achieved by the use of this invention [the transmitter]. I have planned many of the details of a plant which might be erected at the Azores and which would be amply sufficient to illuminate the entire ocean so that such a disaster as that of the Titanic would not be repeated. The light would be soft and of very small intensity, but quite adequate to the purpose.⁽³⁶⁾ Nikola Tesla, 1914

When Tesla used his high power transmitter as a directed energy weapon he drastically altered the normal electrical condition of the earth. By making the electrical charge of the planet vibrate in tune with his transmitter he was able to build up electric fields that effected compasses and caused the upper atmosphere to behave like the gas filled lamps in his laboratory. He had turned the entire globe into a simple electrical component that he could control.

Given Tesla's general pacifistic nature it is hard to understand why he would carry out a test harmful to both animals and the people who herded the animals even when he was in the grip of financial desperation. The answer is that he probably intended no harm, but was aiming for a publicity coup and, literally, missed his target.

At the end of 1908, the whole world was following the daring attempt of Peary to reach the North Pole which he claimed in the Spring of 1909. If Tesla wanted the attention of the international press, few things would have been more impressive than the Peary expedition sending out word of a cataclysmic explosion on the ice near or at the North Pole.⁽³⁷⁾ Tesla, then, if he could not be hailed as the master creator that he was, could be seen as the master of a mysterious new force of destruction.

The test, it seems, was not a complete success. It must have been difficult controlling the vast amount of power in transmitter to the exact spot Tesla intended. The North Pole lies close to a great circle line connecting Shoreham, Long Island and the Tunguska region. That path passes close by Alert on Ellesmere Island where Peary spent the winter.⁽³⁸⁾ The uninhabited region between Alert and the North Pole might have been the intended target for a test firing of the wireless transmission system. However, "the accepted terrestrial measurements" of that day were not precise enough for the task. The destructive electrical wave overshot its target.

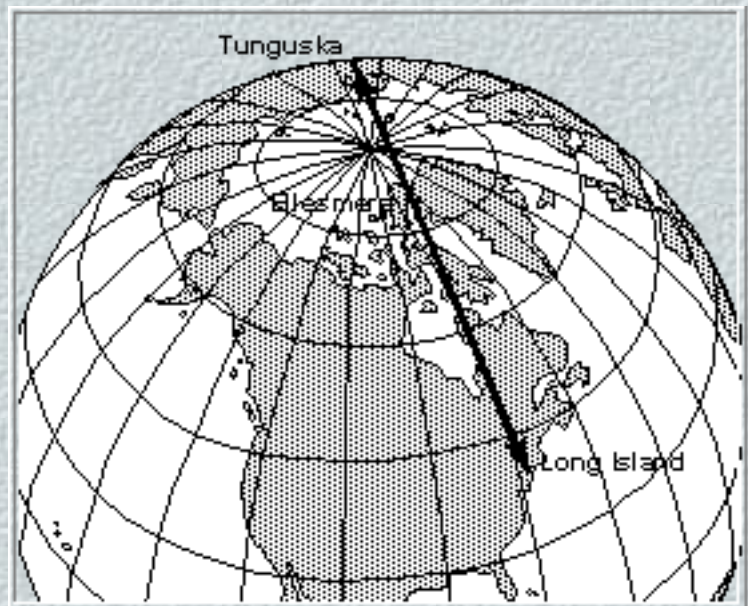

Magnifying Transmitter's Test Path

Whoever was privy to Tesla's energy weapon demonstration must have been dismayed either because it missed the intended target and would be a threat to inhabited regions of the planet, or because it worked too well in devastating such a large area at the mere throwing of a switch thousands of miles away. Whatever was the case, Tesla never received the notoriety he sought for his power transmitter.

The evidence is only circumstantial. Perhaps Tesla never did achieve wireless power transmission through the earth. Maybe he made a mistake in interpreting the results of his radio tests in Colorado Springs and really saw a low frequency phenomenon, Schumann oscillations, and not an effect engineers believe a scientific impossibility. Perhaps the mental stress he suffered caused him to retreat into a fantasy world from which he would send out preposterous claims to reporters who gathered for his yearly pronouncements on his birthday. Maybe the atomic bomb size explosion in Siberia near the turn of the century was the result of a meteorite nobody saw fall.

Or, perhaps, Nikola Tesla did shake the world in a way that has been kept secret for over 85 years.

amazon.com
and you're done.™

**Shop
Now &
Save**

Click here

Privacy Information

- [Electronics](#)
- [Books](#)
- [Music](#)
- [DVD](#)
- [Video](#)
- [Toys & Games](#)
- [Today's Deals](#)
- [Kitchen & Housewares](#)
- [Tools & Hardware](#)
- [Computer & Video Games](#)
- [Outdoor Living](#)
- [Apparel & Accessories](#)
- [Camera & Photo](#)
- [More...](#)

Notes

1. *New York Times*, "Wireless Caused Iena Disaster?", Mar. 19, 1907, p. 4, col. 4.
2. *New York Times*, "Signor Ulivi First Blew Up Gas Meter," Nov. 2, 1913, III, p. 4, col. 5.
3. *New York Times*, "Tells Death Power of 'Diabolical Rays'," May 21, 1924, pg.1.
4. Note 3.
5. *Popular Mechanics*, "'Death Ray' Is Carried by Shafts of Light," Aug. 1924, pgs. 189-192.
6. *Current Opinion*, "A Violet Ray That Kills," June 1924, pgs. 828-829.
7. Note 6.
8. *New York Times*, "Second British Inventor Reveals a Death Ray," May 25, 1924, p. 1, col. 2.

9. *New York Times*, "Suggests Russia Has A 'Ray'," May 28, 1924, pg. 25.
10. *Colorado Springs Gazette*, "Tesla Discovered 'Death Ray' In Experiments Made Here," May 30, 1924, pg. 1.
11. Goldman, Harry L., "Nikola Tesla's Bold Adventure," *The American West*, Mar. 1971, pgs. 4-9; Reprinted by Nick Basura, 3414 Alice St., Los Angeles, Ca. 90065, 1974.
12. Tesla, Nikola, "Famous Scientific Illusions," *Electrical Experimenter*, Feb. 1919, pgs. 692f.
13. One horsepower equals 745.7 watts.
14. Tesla, Nikola, "A Machine to End War," as told to George Sylvester Viereck, *Liberty*, Feb. 1935, p. 5-7.
15. Tesla, Nikola, "The Problem of Increasing Human Energy - Through Use of the Sun's Energy," *The Century Illustrated Magazine*, reprinted in *Lectures, Patents, and Articles*, Nikola Tesla Museum, Belgrade, 1956; reprinted by Health Research (Mokelumme Hill, Calif., 95245), 1973, pg. A-143.
16. Nichelson, Oliver, "Nikola Tesla's Later Energy Generation Designs," IECEC, 1991.
17. *American Examiner*, Copyright 1911, no date, no pg.
18. Tesla, Nikola, *New York Times*, "How to Signal Mars," May 23, 1909, pg. 10. He claims to have sent "a current around the globe " on the order of "15,000,000" horsepower or 11 billion watts.
19. Secor, H. Winfield, "The Tesla High Frequency Oscillator," *The Electrical Experimenter*, March 1916, pg. 615.
20. Wait, James R., "Propagation of ELF Electromagnetic Waves and Project Sanguine/Seafarer," *IEEE Journal of Oceanic Engineering*, vol. OE-2, no. 2, April 1977, pgs. 161-172.
21. Marinic, Aleksandar, *Nikola Tesla, Colorado Springs Notes 1899-1900*, Nikola Tesla Museum, Published by Nolit, Beograd, Yugoslavia, pg.19.
22. Corum, James F., and Corum, Kenneth L., "Disclosures Concerning the Operation of an ELF Oscillator," *Tesla '84: Proceedings of the Tesla Centennial Symposium*, Dr. Elizabeth Rauscher and Mr. Toby Grotz, editors, International Tesla Society, Inc., Colorado Springs, 1985, pgs. 41-49.
23. Tesla, Nikola, "Famous Scientific Illusions," *Electrical Experimenter*, Feb. 1919, pg. 732.

24. Note 22.
25. Nicholson, Oliver, "Tesla's Wireless Transmission Method," 1992.
26. Tesla, Nikola, "Tesla's Wireless Torpedo," *New York Times*, Mar. 20, 1907, pg. 8.
27. Tesla, Nikola, *New York Times*, "Mr. Tesla's Vision," April 21, 1908, pg. 5.
28. Seifer, Marc J., "Nikola Tesla: The Lost Wizard," *Tesla '84: Proceedings of the Tesla Centennial Symposium*, op. cit., pgs. 31-40. Seifer, a psychologist, believes Tesla suffered a nervous breakdown catalyzed by the death of one of the partners in the Tesla Electric Company and the shooting of Stanford White, the noted architect, who had designed Wardencllyffe. Seifer places this in 1906 and cites as evidence a letter from George Scherff, Tesla's secretary:
- Wardencllyffe, 4/10/1906
- Dear Mr. Tesla:
- I have received your letter and am glad to know you are vanquishing your illness. I have scarcely ever seen you so out of sorts as last Sunday; and I was frightened.
29. Cheney, Margaret, *Tesla: Man out of Time*, Dell Publishing Co., N.Y., 1983, pg. 187. Cheney sees a mental change taking place about 1907. Having lost most of his money and many of his friends and seeing less talented people praised for achievements based on his inventions "exerted a corrosive and lasting effect on his personality."
30. Tesla, Nikola, "Tesla's New Device Like Bolts of Thor," *New York Times*, Dec. 8, 1915, pg. 8.
31. Baxter, John and Atkins, Thomas, *The Fire Came By*, Warner Books, N.Y., 1977, pg. 27.
32. Note 30, pg. 26.
33. Spenser Russell quoted in Baxter and Atkins, *The Fire Came By*, page 28, from the *Royal Meteorological Society Quarterly*, 1930.
34. Note 30.
35. The earliest mention of lighting the ocean appears to have been in 1911 in a *N.Y. American* article (Sept. 3rd by Marcel Roland). Ratzlaff, John and Anderson, Leland, *Dr. Nikola Tesla Bibliography*, Ragusan Press, 1979, pg. 93.

36. New York *American*, "Tesla Light to Rob Oceans of Every Danger," Dec. 7, 1914, no pg.

37. Tesla suggested a similar test of his power transmission system aimed at the moon where everyone could see "the splash and volitization of matter." See note 19, pg. 255.

38. Bayshore, L.I. is at 40 N 43, 73 W 13; Alert, Canada (Ellesmere Island) 82 N 31, 62 W 05, and Tunguska at 60 N 55, 101 E 57.

Return to [Table of Contents](#)

E-mail: onichelson@post.harvard.edu

NIKOLA TESLA:

[\[Home\]](#)[\[Tesla Technology, Today\]](#)[\[Nikola Tesla\]](#)[\[Nikola Tesla - Links\]](#)

[\[The Tesla Engine\]](#)[\[Tesla Tunguska; Free Energy\]](#)

[\[The Tesla Bladeless Boundary Disk Turbine\]](#)

[\[Tesla's "Black Box"\]](#)[\[Greatest Hack of All Time?\]](#)

[\[the Lost Tesla Inventions\]](#)[\[A Machine To End War\]](#)

[\[the Wonderworld to be Created by Electricity\]](#)

[\[the Telsa & Schauburger Bookstore \]](#)

VIKTOR SCHAUBERGER:

[\[Water Power - Vortex Theories-\]](#)[\[Water Power II\]](#)

[\[Viktor Schauburger -1-\]](#)[\[Viktor Schauburger -2-\]](#)[\[Viktor Schauburger -3-\]](#)[\[Viktor Schauburger -4-\]](#)

[\[Christian Links\]](#)



APPLIED VORTEX MECHANICS

There is a new awakening on the horizon!

[HOME PAGE](#) / [INTRODUCTION](#) / [SCHAUBERGER](#)

IMPLOSION

vs.

EXPLOSION

- [SUCTION TURBINE vs. PRESSURE TURBINES](#)
- [SUCTION PROPELLER vs. PUSH PROPELLER](#)
- [LEVITATION DISC vs. AIRCRAFT](#)
- [IMPLOSION MOTOR vs RECIPROCATION MOTOR](#)
- [PROPELLERLESS DRIVE FISH MOTOR vs. OUTBOARD MOTORS](#)
- [PROPELLERLESS DRIVE FISH MOTOR vs. SHIP PROPELLER DRIVE](#)
- [PROPELLERLESS DRIVE FISH MOTOR vs. SUBMARINE WITH PUSH PROPELLER](#)
- [NATURAL FUELS vs. FOSSIL FUELS](#)
- [IMPLOSION REACTOR POWER PLANT vs. NUCLEAR REACTOR POWER PLANT](#)
- [TRANSPORTATION OF MEDIUMS via "TWISTER PIPES" vs. CIRCULAR PIPES](#)
- [EGG SHAPED WATER STORAGE vs. CONVENTIONAL WATER STORAGE](#)
- [CENTRIPETAL PUMP vs. CENTRIFUGAL PUMP](#)
- [WATER TREATMENT PURIFICATION via VORTEX FUNNEL vs. PLANT \(CHEMICAL\)](#)
- [TRANSMUTATION OF THE ELEMENTS vs. METAL/MINERAL MINING](#)
- [POLLUTION CONTROL DEVICES vs. INDUSTRIAL POLLUTION](#)
- [VORTEXIAN WATER & SOIL TREATMENTS vs. AGRICULTURAL CHEMICALS](#)
- [HEART-SHAPED VORTEX PLOW vs. CONVENTIONAL STEEL PLOW](#)
- [MOLE SCREW TILLER vs. RANDOM TINE TILLER](#)

The dawn of a new century will herald attitudes and methods which will allow REVERSALS from our present destructive paths in Technology, Agriculture, and Psychology.

Does anyone of you question the necessity of a reversal?

There are warnings coming in from many societies, governments, agencies, scientists and farmers which warn us that our use of fossil and nuclear fuels poses unacceptable risks of climate and environmental destruction, at unsupportable costs.

Yet, we know Mankind's needs are increasing. The question becomes if not coal and oil, and if not nuclear, then what?

In this same issue we hope to sketch an outline of a new energy source that gives vast promise for improved energy efficiency, renewable power sources, that offers the actual creation principle to re-create, procreate, if you will, water, air, power and growth! We call it a New, Nondestructive Technology based on principles of Implosion.

Combustion and explosive engines, radiating power sources and all our present prime movers upon which the modern world depends do not even work to a 50 percent efficiency. More than one half the energy is destroyed or wasted. Why do they perform so badly?

By a close observation of Nature we can see the answer ; we use the wrong type of motion to accomplish our work!

There exist two forms of motion within Nature - one that breaks down and the other that builds up and refines. Both work in a rhythmical balanced, interchanging cooperation with one another.

The form of movement which creates, develops, purifies and grows is the hyperbolic spiral which externally is centripetal and internally moves along the longitudinal axis. The destructive and dissolving form of movement is centrifugal and moves towards the periphery. With centrifugal

movement mediums are first weakened, then dissolved and broken down. This is the way Nature disintegrates her complexes.

The centripetal movement is synchronous with falling temperature, contraction and concentration. The centrifugal is synchronous with rising temperature, heat, extension, expansion and explosion.

Within the text are contrasted the New Technology called Implosion Technology and the present Technology which is one based on Explosion.

It should be apparent that our present Tech's poor results are because of Nature's resistance to man's single-minded pursuit of explosion, destruction and decomposition. The over heating problems of our machines, air resistance, temperature and sound barriers are evidence that man is on the wrong destructive path in technological pursuits.

In the case of turbines as shown below, which are designed for the extraction of mechanical energy on a shaft, we call the turbines under the implosion side "suction" turbines (**B1**) or Implosion machines. The suction turbine performs work under the contraction principle of Nature; whereas, the turbines headed under explosion (**B2**) perform work under the expansion pressure principle of Nature.



TOP

Both types of turbines are reactors or Implements which release reaction forces. The suction turbine when activated with water or air becomes a generating or constantly regenerating, synthesizing device. The pressure turbines, whether activated with water, air or other well known fuels, become degenerating, analytical devices. The pressure turbines deplete their mediums of their vitalizing energy and perform with poor efficiency because of the heat and resistance which increases by the square of the speed of rotation. The machine as a whole is prevented to generate its total power because of the centrifugal movement of the medium. The pressure turbine uses the gravity or expansion pressure of a medium. This turbine produces Hp on its shaft according to the limited expansion pressure capability of a medium.

The suction turbine does not need pressure expansion force or a pressure head and can therefore, operate anywhere as a closed system. Damming of water and high cost pen-stocks are not necessary. The suction head, to lift water to its piping system, is a built-in feature in this suction turbine. It is for this reason that the rotor is driven by an external force. In order to produce suction to lift its own operational water.

The higher the rpm of the rotor the more operational water is lifted which results into a greater power output on the shaft. The sucked-in water is mechanically and physically involuted, coiled, braided and compressed by vortexian action. The rotation of the convoluted pipes produces a longitudinal, centripetal force which expresses itself through constructive reaction force and is limited only by its rotational speed.

Compare suction propeller (A1) with pressure propeller (**A2**). Both props were invented by Austrians. The suction prop, or screw, was invented by Victor Schaubberger in the 1930's and 40's during the Second World War and the pressure prop by Ressel in 1820. Both constructed models of their machines. Both were rejected by science and technology at first. Ressel's push prop was, after many years of resistance, finally accepted. Today it is little known that "propulsion" can be accomplished by pull as well as thrust, and with advantages.

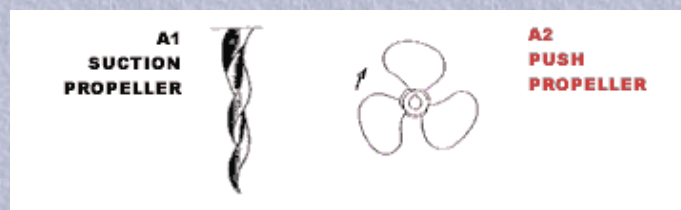

TOP

Schaubberger's suction prop has never been accepted by science.

The forces acting in the suction turbine are the exact opposite of those acting in the pressure turbine. Nature moves everything through temperature and potential differences, besides the usual, known gravitational fall, which produces hydraulic pressure. Power is invited into a vacuum devoid of resistance rather than forced and pushed only to react with more pushing and resistance.

It is to be understood, that there is no heat input required in any of the implosion systems indicated; whereas, in the explosion systems it is all heat which does the work, and the destruction of the medium.

The suction propeller pipes accommodate the medium of air as well as water and have been experimentally used to produce a levitating disc (C1) fueled only by air. These discs can one day replace the polluting, inefficient, fuel consuming aircraft (C2) of today.

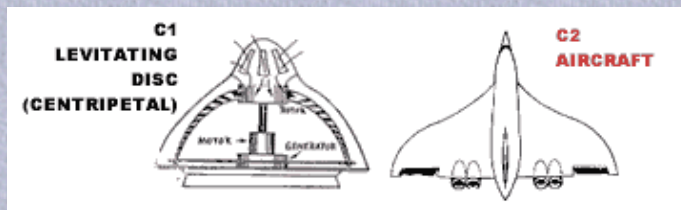

[TOP](#)

Let us go briefly through the main cycle of the Implosion Motor as shown in (D1). The fuel medium is first specifically compressed centripetally (not centrifugally or hydraulically) through the twisted, indented pipes and then released through specially designed nozzles to mechanically react on a toothed ring (now we are using centrifugal expansion action). Apparatus as in (D1) allows for the "complete cycle" of a liquid or gas medium to "oscillate" or cycle atomically and molecularly from one state of potency its opposite, within its natural metabolic range, without being destroyed. During "the change of potential" work is performed by the fuel. This is the way Nature does it. Apparatus as indicated in (D2), the reciprocating, combustion motor, allows only for half of the cycle, that is, expansion pressure only. The regenerating cycle has to constantly be replaced with more and more medium like the well known fuels of gas or oil which are degenerated & depleted of their energy or changed totally into another substance worthless to be reused for the same purpose.

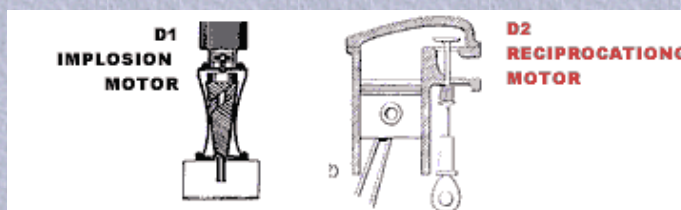

[TOP](#)

Implosion devices make use of centripetal motion to create conditions of less resistance. The Propellerless Fish Motor (E1) for instance, is a prototype device which will one day replace the sluggish and destructive chopping and flailing of the present boat (E2), ship (E3), and submarine (E4) propeller. The fish motor uses anterior suction to remove resistance in front of the device and at the same time uses the vortexian spiral to "wedge" and propel the body into the anterior vacuum. In Nature fish, sharks, dolphins and other marine life control vortexian processes in a similar way for their propulsion. These Fish Motor Devices are silent and will serve to greatly improve submarines.

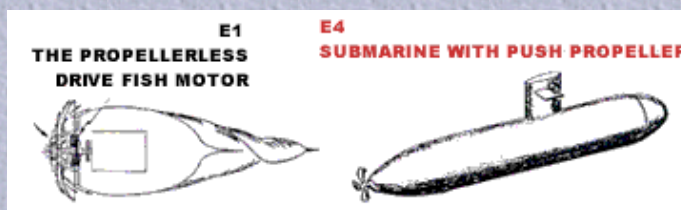
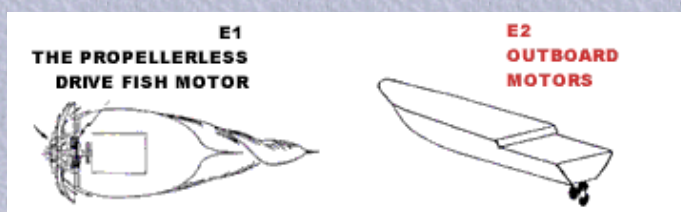

[TOP](#)

Implosion devices will allow us to use and recycle Natural Fuels such as water and air **(F1)** instead of laborious, destructive and polluting processes of drilling, refining and burning our gas, coal, and oil **(F2)**. We can do away with damming, interfering with our natural water flows and damaging the quality of the water by pressurizing it through disintegrating turbines at Hydroelectric Power Plants **(F3)** for the extraction of its power.

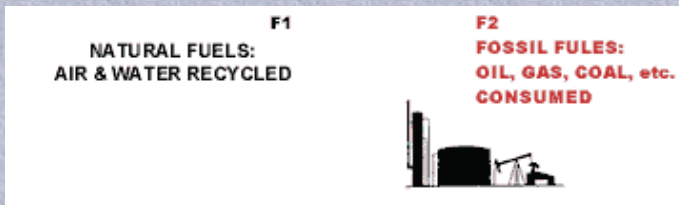

[TOP](#)

Implosion technology with its operation based on constructive, exponential reactions will allow us to replace the deadly nuclear power plants **(G2)** with Implosion Reactors **(G1)** which produce several times the power with NO radioactive contamination or by-products!

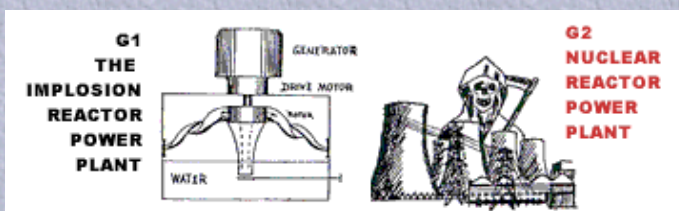

[TOP](#)

The technique of gaining energy through the splitting of the atom is an offense against Nature, and the commitment of our society's future to total destruction. It is now a known fact -that one can make use of atomic power through Implosion. We must explore and develop this constructive avenue!

Specially designed "Twister Pipes" for transportation of water **(H1)** (and other liquids and gases) are designed to move mediums in vortexian fashion and should replace circular straight pipes **(H2)** to prevent the molecular disintegration of the medium which occurs in conventional straight pipes.

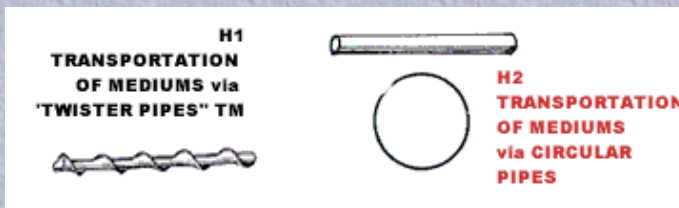

[TOP](#)

Egg-shaped water storage containers **(I1)** should replace conventional water storage containers **(I2)** because the egg-shape aids water circulation and prevents the stored water from heating, lying still, and becoming a stale, dead, bacteria - supporting liquid.

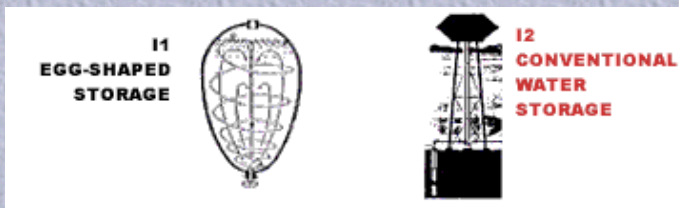

[TOP](#)

In the future, Implosion pumps **(J1)** which twist huge volumes of water through, in a funnel fashion can replace the inefficient, chopping operation

of the centrifugal pumps (J2) of today.

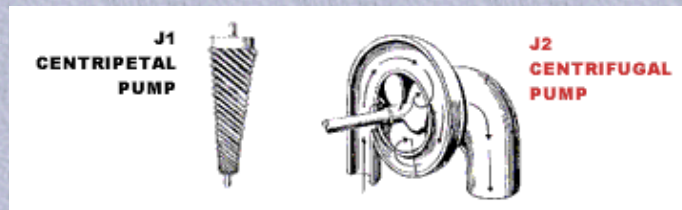

[TOP](#)

An immediate solution application of the vortexian action of Implosion devices is in the treatment, purification and separation of wastes In Industrial and Municipal water and liquid mediums. Waste management and water treatment are a skyrocketing expense rivaling -fuel and source input expenses and gobbling more of the profits yearly.

The strategy of finding dump sites, hauling to landfills or just "covering up" must be stopped. This is no solution.

There will always be some unwanted chemical residues, some solid waste, some resulting by-product mixed in waste and sewer liquids with our present methods; however, we can now with Implosion Devices think of handling them chemically; molecularly transmuted and transforming them to nonhazardous materials while in-line, in process!

By copying the cycloidal, vortex action which Nature uses for it's purification processes, vortex purification devices have already proven effective to replace chemical municipal waste treatment plants (K2). We will have a later issue of these success stories and devices.



[TOP](#)

A Turbulent Funnel Water Purifier (KI) is a purification and separation device. This funnel, consisting of a large container shaped like half an egg, has a perforated pipe several meters long attached to its bottom. A liquid medium laden with solids or chemicals of different density can be separated by swishing through this device.

The solids will coagulate into egg shaped forms, gather in the middle shaft and can be led off. The egg-shaped solids will be found to contain no more moisture. Such devices work for mechanical and molecular separation by subjecting the medium to controlled vortex action.

Experimental work in Implosion Technology has proven that we can create substances by a constructive hyperbolic process of synthesis. The synthesis of hydrocarbons suitable for fuels has been accomplished! Low quality raw materials can be enriched to create products with a high energy content. Low grade oil, iron ore or coal can be upgraded by subjecting them to centripetal devices such as shown in (LI). Even "highly potent water" has obtained traces of a petroleum-like product in these apparatus. When this water was sprayed into a cylinder and a quantity of natural oxygen added, a light pressure created by a descending piston is sufficient to transform the highly potent water into a gas!

We have the beginning to create our fuels to solve the problems of deforestation for fuel and the digging, drilling, scarring and disturbance of our present mining techniques. (L2)

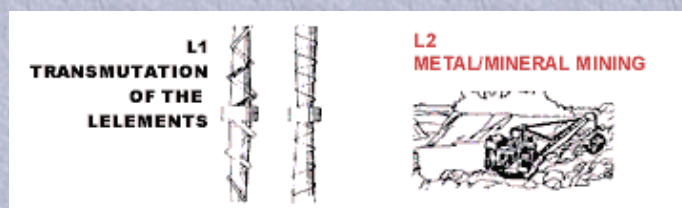

[TOP](#)

Vortexian action has been applied to pollution control devices such as chimneys (**M1**) and chambers for the separation of gases from liquids or from other gases. For example, there is a patent today for the separation of sulfur dioxide from exhaust gases. The application of such devices can stop the acid rain which is such a pollution problem of industrial coal burning (**M2**). These devices can purify the exhausts on motor vehicles and heating installations.

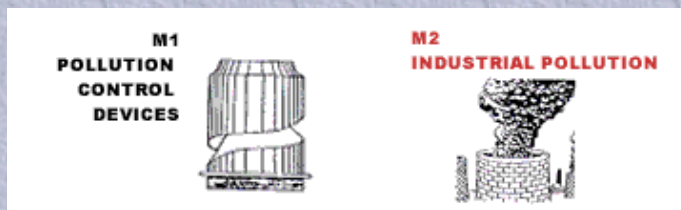

[TOP](#)

Agriculture is an area which will see benefits of Implosion Technology. Farmers have been racing against the rapid evolution of crop pests and the rapid disintegration of soil and water fertility because of the chemical forming methods (**N2**) presently employed. We can break the artificial fertilizer and pesticide habit with Implosion Techniques.

Chemicals are not necessary - neither for fertilizer or a war against pests and disease, if certain methods of water and soil treatments, (**N1**) with an awareness of vortexian principles, are observed instead.



[TOP](#)

With the use of specially designed implements (**O1**) (**P1**) to alter conventional plows (**O2**) and tillers (**P2**), farmers can treat their soils to the vortexian benefits of the soil creatures such as the mole and the earthworm. They can reverse the upset occurring in the layers of our soil and stop the dehydration and topsoil erosion problems. For every ton of grain American farmers produced last year, they lost six tons of their topsoil!

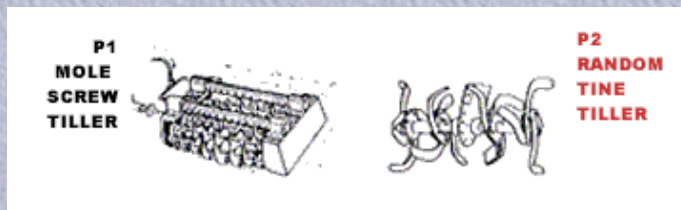

[TOP](#)

We are not here to take our Earth's resources! They are here in abundant and naturally regenerating cycles for us to observe in respect and learn from. We can learn to imitate the Creation processes of Nature! We are not doomed to rob and squander the precious gifts of energy, water, air and soil. We can learn to create these vital resources nature uses with the some mechanical processes.

The principles are contained in Implosion.

Two Products That I Endorse are the "Electron 3 & 4 Living Water Machine" and the "Wellness Filter Line":



FutureTech Today introduces the Electron 3 & 4 Living Water Machine. This machine is being marketed through Future Tech Today, made by "For Health Reasons" of Chicago Illinois, USA. (makers* of quite probably the best water filtration system, based on victor Schaubberger's ideas, of coarse, on the planet! Purer Distilled Drinking Water:

When vapor turns to rain, it passes through temperature gradients where the temperature is continually changing with oxygen. This process stretches and contracts the H bonds that hold the molecules together...this creates ENERGY! Plant diseases are caused by viruses and bacteria, and our method of autoclaving them, using INTENSE HEAT, DESTROYS THEM (NOT just boiling).

The research chemist and others spent thousands of dollars on every product on the market, and ONLY OUR METHOD prevented the diseases in plants and caused incredible growth by just dropping plant buds in the water. Root growth 2 1/2 inches long compared to 1/8 of an inch in any of the others during the same time frame...even compared to water with nutrients added to the it!! This test was REPEATED over a period of three YEARS ...so there is no mistake!. The BOTTOM LINE is that today's ordinary water is DEAD! Why would ANYBODY want to use DEAD water, and yet most people do! If you can afford the rather steep price of their units, it is well (no pun intended!) worth the price, from personal use, on my end.

*The company that originally produced this unit is listed below - "For Health Reasons" of Chicago, IL.

The company SELLING (marketing) the unit is **FutureTech Today**... "Future Tech Today was founded in 1998 with ambitions to break the latest energetic healing technologies to the general public while maintaining a research and development program allowing them to bring tomorrow's technology today. The idea was to represent the latest technological research in the fields of energetic medicine, water vitality, and EMF (electromagnetic field) protection products. They represent products and technologies from all over the world, many of which are in very early stages of production or still in research phases; in this way they give the general public a preview of technologies to come..." (from their website, and used here for endorsement sake) FDG



FutureTech Today introduces the Wellness Filter! This is the **Wellness Filter®**, and comes in various sizes to suit individual needs. In my humble opinion - it's the best on the market, today. Pricy, but well worth it. Again, this product is offered through FutureTech, Today. For website info, use either their link - **FutureTech Today** - or <http://www.wellness.com.au> (If you go to wellness.com.au directly, you can even become an associate, an affiliate, or a partner-type program with them if you meet their strict company requirements).

"The Wellness Filter® offers you and your family a quality of water that Nature has provided to only a select few. By using natural purification processes in combination with advanced technology, the Wellness Filter® produces what many believe is the best drinking water on Earth. The Wellness Filter® not only removes harmful contaminants but it also enhances the water through a patented process that creates a quality of water beyond the reach of conventional water filters. Clean water plays a vital role in your health, fitness and appearance..." (from the FutureTech Today website).

[INDEX](#)

[HOME](#)

[VIKTOR SCHAUBERGER](#)

PATENT SPECIFICATION (BRITAIN)

415,280

Convention Date (Austria): Nov. 2, 1932.

Application Date (In United Kingdom): Oct. 31, 1933. No. 30,236/33.

Complete Accepted: Aug. 23, 1934.

COMPLETE SPECIFICATION.

Improvements in or relating to Water Conduits.

I, VIKTOR SCHAUBERGER, an Austrian citizen of I. Rengasse 6, Vienna, Austria, do hereby declare the nature of this invention, and in what manner the same is to be performed, to be particularly described and ascertained in and by

The following statement:

This invention relates to means for improving the flow of water or the like in pipes, channels and other conduits, made of such materials as conduits are normally made of, for example, cast metal, sheet metal, wood, earthenware, and so forth.

It is already known to improve the flow of water in pipes and channels by providing them with guide-blades which project from the wall towards the centre, the faces of the blades being curved in such manner as to force the water from the wall towards the middle of the water-conduit, to which end the blades are in the form of a plurality of helices, similar to multiple thread rifling. Further it has been proposed heretofore to provide the faces of guide-blades with grooves running spirally in the direction of flow of the water.

The object of this invention is to provide an improved construction or arrangement of guide-blades whereby the forward motion of the water in the core zone is favored in comparison with the flow of water in the region of the walls. Simply stopping the flow of the wall zone would cause turbulence in the region between the core and wall zones, and the production of a sufficiently well formed core zone would be unfavorably influenced.

In the case of this invention however, the wall zone of the water is divided up into separate whirl formations which are of such a structure as to possess sufficient interior stability to have little tendency to break up, and therefore as a whole to produce a sheath of water favourable to the progress of the core water.

In accordance with the foregoing, according to the present invention, guide-blades are employed which are twisted in the manner of turnings in such manner that two co-operating guiding members having screw-like surfaces are formed, one of which separates the wall zone of the water current from the core zone whilst the subsequent guiding member in the direction of flow imparts a rotary motion to the separated wall zone of the water, whereby the wall zone of water is divided up into separate stable whirls. The invention is preferably applied to guide-blades which are disposed in the conduit along multiple spiral lines, producing a multiple rifling effect, so that the wall zone of the water progresses with a generally spiral motion.

In carrying the invention into practice the guide blades may be in the form of substantially rhomboidal strips, the

diagonally opposite obtuse angled corners of which are bent up towards the same surface of the blade.

The invention is illustrated by way of example in the accompanying sheet of drawings in which Figure 1 is a plan view of a guide blade, and Figure 2 shows a pipe section with a guide blade therein, viewed against the direction of flow. Figure 3 shows the developed surface of a guide blade.

The guide blades are twisted in the manner of turnings, so that two guide members are formed, one at each end, as shown in Figure 1. These two guide members impart a spiral motion to the wall zone of water which flows generally in the spiral direction 3, thus producing a spiral sub-motion of the wall zone within its general spiral movement.

The guide blades 2 are preferably, as shown, disposed in the pipe 1 along multiple spiral lines 3, it being understood that, for the sake of clearness, one blade only is shown in the drawings. The guide member 4 of the blade 2 serves to impart a spiral flow directed away from the centre of the conduit, so that the wall zone becomes separated from the core zone of the water, whilst on leaving the part 5 of the blade, a spiral movement directed towards the middle of the conduit is imparted to the wall zone of the water stream. The action of the strips 2 is improved by ribs 6 provided on the surfaces of the strips 2 as shown in the drawings, and the ribs may be thicker at the roots than at the tips so that the intermediate grooves narrow towards the surface proper of the strip 2.

Instead of being formed from a common strip 2, the guide members 4 and 5 may be made separately from each other. The guide blades may be made of metal, wood, clay, earthenware, or of any other suitable stiff material.

Having now particularly described, and ascertained the nature of my said invention and in what manner the same is to be performed, I declare that what I claim is: -

1. Water conduits having blade like elements projecting from the wall towards the central portion of the conduit, and providing guiding surfaces for the water, wherein the guide blades are twisted like turnings, so as to produce two co-operating blade like members having screw like guiding surfaces, one of the said members separating the wall zone of the water current from the core-zone, whilst the subsequent member in the direction of flow imparts a rotary motion to the separated wall zone of the water, whereby the wall zone of water is divided up into separate stable whirls.
2. Water conduit according to claim 1, wherein the guide blades are disposed in the conduit along multiple spiral lines, producing a multiple rifling effect, so that the wall zone of the water progresses with a general spiral motion.
3. Water conduit according to claim 1, in which the guide-blades are in the shape of substantially rhomboidal shaped strips, the diagonally opposite obtuse angled corners of which are bent up towards the same surface of the blade.
4. Guide members for use in water conduits, or water conduits provided with guide members constructed arranged and adapted to operate substantially as described and illustrated with reference to the accompanying drawings.

Dated this 31st day of October, 1932.

CHARLES S. PARSONS,
Chartered Patent Agent,
Thanet House, 231, Strand, London, W.C. 2.

415,280 COMPLETE SPECIFICATION

1 SHEET

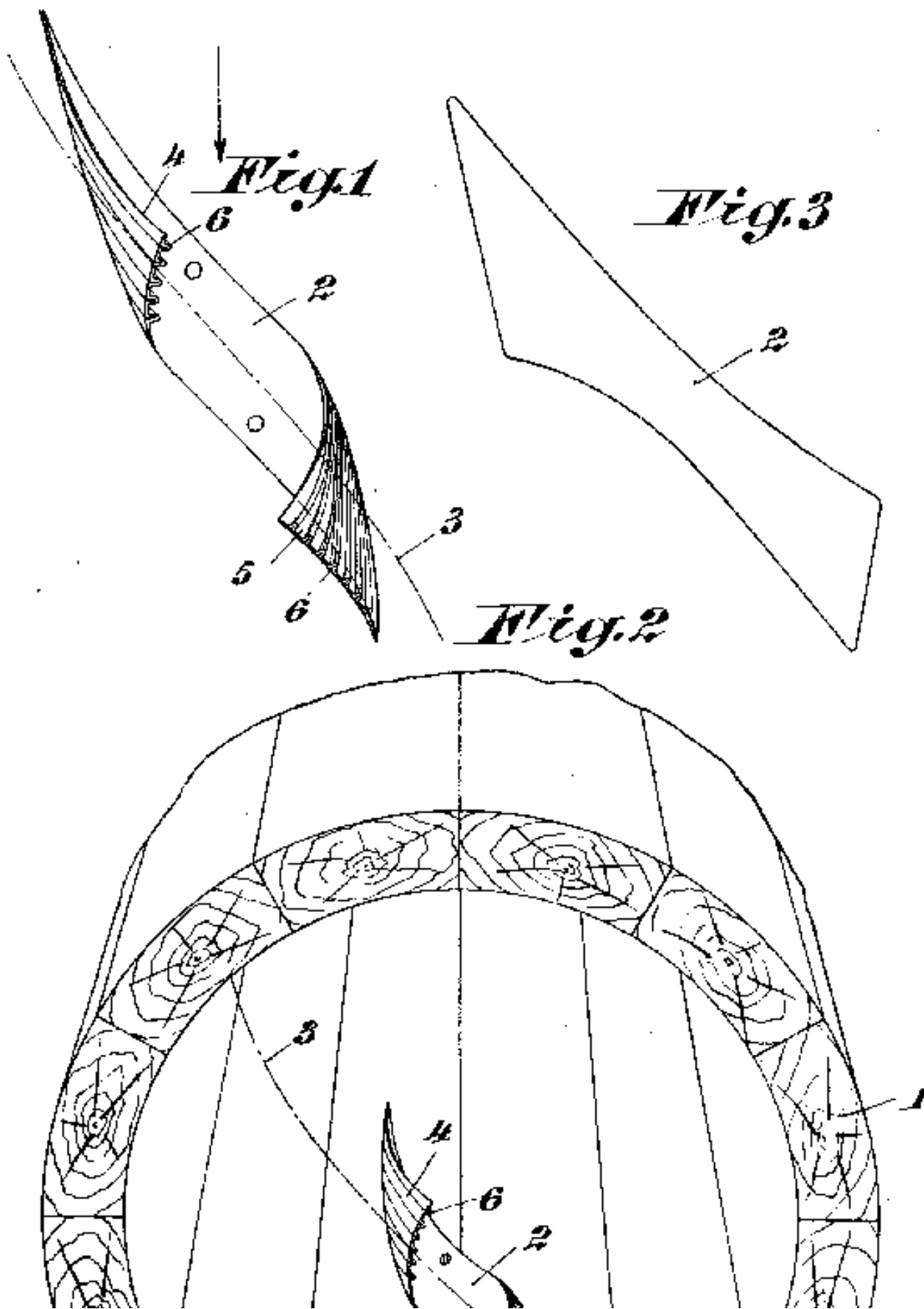

[This Drawing is a reproduction of the Original on a reduced scale.]

12

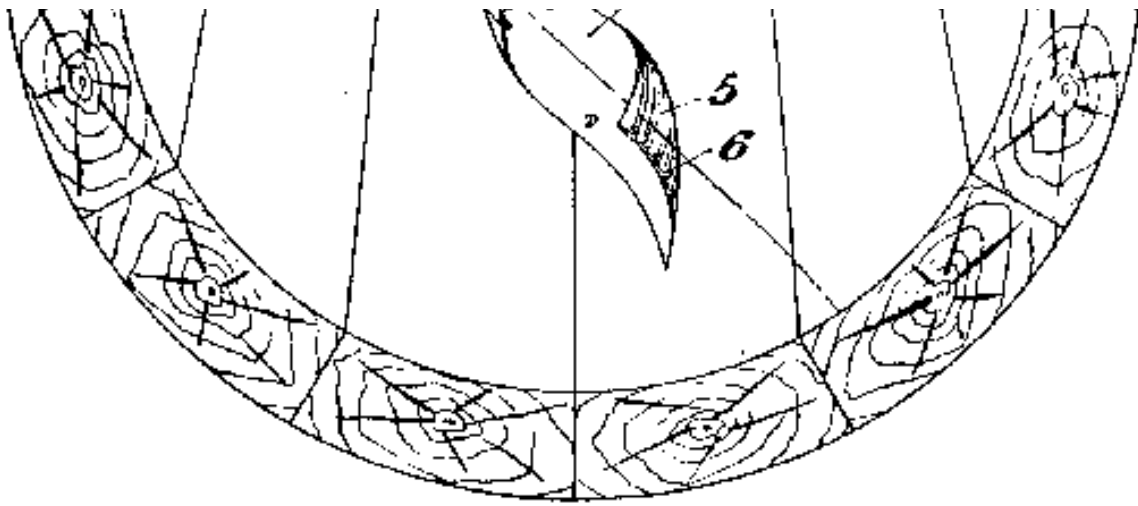

Maby & Sons, Photo-Litho





TWO: The Viktor Schaubberger bookstore -

[\[back to INDEX\]](#)



Save big on thousands of products!

Computers
Books
Music
DVDs

amazon.com
and you're done.
Click Here

 <p>The Fertile Earth Viktor Schaubger... New \$13.57!</p>	 <p>The Water Wizard Viktor Schaubger... New \$12.89!</p>	<p>Land der Traumer Rene Freund Used \$9.00!</p>
 <p>Living Water Olof Alexandersson... New \$11.95!</p>	 <p>Nature As Teacher Viktor Schaubger... New \$12.21!</p>	 <p>Living Energies Callum Coats New \$17.79!</p>
 <p>Living Energies Callum Coats New \$19.95!</p>	<p>Det levande vattnet Olof Alexandersson...</p>	<p>The Schaubger Companion Callum Coats New \$21.95!</p>

(Prices May Change) [Privacy Information](#)



Save \$20 on your first purchase at Amazon.com

earn **Free Rewards**

[Learn More](#)

[Privacy Information](#)

Books relating to Viktor Schaubberger, the "water wizard"

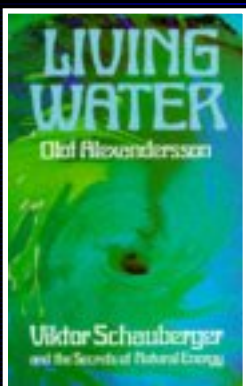

The original translation of Viktor Schaubberger's work, "Living Water", by Olof Alexanderrson...start here, and get each one in order. This is an excellent, brief introduction to the thought of Viktor Schaubberger, and I hope it inspires works which are more complete. Callum Coates' books reach in this direction, but what is really needed are more people to read these books, synthesize their information, and come up with new and original books which take us further into depth in these areas. This will probably involve synthesizing the work of Schaubberger, Grander, Bienveniste, and others. An understanding of Schaubberger is very important for those attempting to reconstruct an Indigenous European Perspective. Schaubberger has the elements of a modern water shaman, and his shamanic / intuitive techniques of letting his body float with the water should be closely correlated with what Hans Peter Duerr has to say about "out of

body" experience in his tome "Dreamtime". Although Schauberger lived in the 20th Century, his perspective allows us to imagine back what earlier indigenous practitioners may have been like. The Colonial, Imperialist Europe is only one side of the coin of Europe. We must also include the suppressed indigenous, pagan, and green sides. Significantly, the Inquisition represents a watershed in European history where a great deal of the indigenous healers and theorists were wiped out in holocaust proportions. An understanding of Schauberger, coupled with an appreciation of Steiner, Hildegard of Bingen, Hans Peter Duerr, and others, will allow us to reconstruct what a noncolonial, nonimperialist Europe was like. Understanding water's nature is essential in this regard, for water forms the basis of our understandings of flow. Furthermore, understanding water's energetic qualities will help us understand how it interacts with the body. Traditional Chinese Medicine, for example, would benefit from an accurate and holistic understanding of water's qualities. In short, this book is an excellent appetizer.

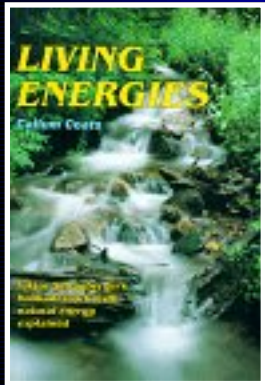

The book that started it all...[Living Energies](#), Callum Coats first Viktor Schauberger book. If you only buy one book, this would be the one to get. Fantastic. [Living Energies](#), May 23, 2001

Reviewer: Frank D Germano, from Tafton, PA United States: This book started it all! Callum Coats basically brought to "light" the resurgence of interest in Viktor Schauberger's theories. This is truly a brilliant work. Water as a carrier of vital energy information, trees as bio-condensers of energy between the deep earth and the sun, how self-cleansing rivers nourish the landscape, how the future of the earth

depends on the replanting of natural forests, revolutionary agricultural implements, free energy heater-coolers, jet engines and gravity defying machines invented by Schauberger in the 30's and 40's, home power generators...it's pretty much all here. It was a hard book for me to put down once I started reading, and I go back to it continually for reference. This book pretty much sums up Schauberger's work, which Coats then compartmentalized and expanded in the "Eco-Technology" series with four other books. I would highly advise getting this book, first, and reading it thoroughly, before moving on to the series, as it is a fascinating preface into discovering who Viktor Schauberger WAS, and learning just how far-reaching his theories were, and applicable to us, today. FDG.

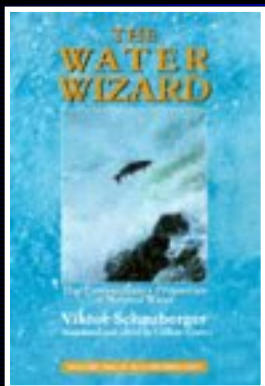

1.) The first book of the "Eco-Technology series" - [The Water Wizard](#) - This book gives a lot of history on Schauberger. The nature of water, May 23, 2001

Reviewer: Frank D Germano, from Tafton, PA United States: This is the first book of the "Eco-Technology" series, and as so, gives you the foundation of the theories presented by Viktor Schauberger, and amplified by Callum Coats. It DOES contain quite allot of previous information written in Living Energies (Coat's first Schauberger book), however, the discussion and the text is much more thoroughly covered. The substance of water, water supply, deep-sea water, the consequences of drinking

purely mechanically treated water, notes on the secrets of water, high-frequency water, the pulsation and healing power of water, river regulation, groundwater tables, temperature and movement of water... notice my use of the word WATER. Yes, this book is about water, but, by reading it, just wait until you discover what you DID NOT know about "water". It is a very good start, and as I said, a foundation for understanding the theories of Viktor Schauberger. FDG.

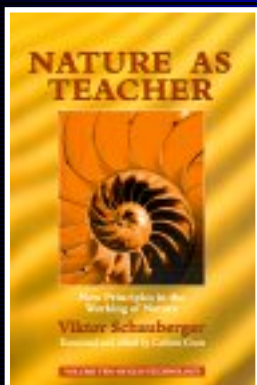

2.) Part two of the "Eco-Technology series" Nature As Teacher, A great book on living with nature. A very nice read.

Our Senseless Toil, May 23, 2001: Reviewer: Frank D Germano, from Tafton, PA United States: I had to use a title from one of the books' opening chapters. This book is going to annoy some people. Callum Coats presents Viktor Schauberg's theories in a modern light. The laws of Nature, Questions for Science, Nature as Teacher, the fish-eagle, the swing, the trout, the ox, dancing logs and stones, the Genesis of water, the coming bio-technical age, the secret of the egg form...these are

elucidated...then comes the fun stuff... the age-old secret of the atom, implosive breathing, life-force and animated breathing, is there perpetual motion (?), organic syntheses, the false world view, the mechanical equivalent of heat, plasmolytic motion; this volume gives tremendous insight into what is happening in the world, today, and practical solutions on HOW we may yet save our world. Most telling is Schauberg's inane gut feelings on the powers at work in the environment, and living water. Hey, it's only volume two of the series. Get all four, and see how these books will influence YOU to change the way we look at the earth . FDG

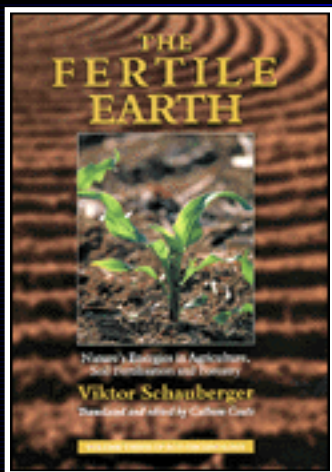

3.) The Fertile Earth , part three of the "Eco-Technology series. Pure drinking water, how to make it, the benefits produced in the body...the natural flow and paths of rivers, and how man has disturbed nature...organic, natural farming...trees as the life giving force on the earth...it's all hear! Are you trying to save Mother Earth?, May 23, 2001

Reviewer: Frank D Germano, from Tafton, PA United States: If you are in any way interested in the environment, then this book will appeal to you. This is the third book in the highly acclaimed "Eco-Technology" series by Callum Coats.

Not only does the book delve into what man is doing to harm the environment, it also offers "fresh" ideas on what we can and should DO about it. I can't believe "Green Peace" or some other pro-environmental group doesn't have this book as part of their by-laws! Fascinating. Of coarse, the entire book is based on the revolutionary work of Viktor Schauberg. This one, if you are into farming, just have a back-yard garden, or are a hard core pro-earth person, will keep you reading till the end...and want to read the entire series. A very well written and inspiring book. A different view of natural phenomena, the influence of temperature and water movement, forestry, agriculture, the energy industry, the dying forest, timber and water in the building industry, soil fertilization, increased productivity...wow! Again, whether you are just into learning what's happening to the earth, and why, or you are serious about trying to DO something to stop the damage already done, this book will open your eyes. FDG

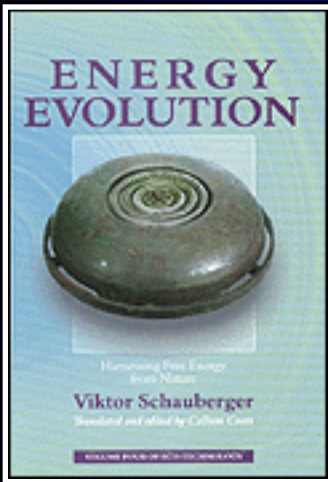

4.) The Energy Evolution , the final book of the "Eco-Technology series" (If you are interested in the designs and patents on Schaubberger's devices, this is the book. Culmination of the Eco-Technology Series, May 23, 2001

Reviewer: Frank D Germano, from Tafton, PA United States: This book, being the fourth and last of the Eco-Technology series, is an incredible finish. Naturally, all of the book deals with Viktor Schaubberger, and his theories on living water, and the environment. This book, however, goes deeper into the actual inventions than the previous ones. It contains almost all of Schaubberger's patent information, most of which, even though "lost" originally, is now amplified and explained by Callum Coats. The Trout Motor, the Repulsine, and the rest of Viktor's inventions fall in place like a well stacked deck of cards. You could very

easily build these wonderful engines, yourself (with some help from a good machine shop, of coarse!). If you have waited for the conclusion of the series, your wait will be well worth the time. I highly suggest you pick up this copy. FDG

The Newest Book out on Viktor Schaubberger, and it is simply amazing! **Hidden Nature, by Alick Bartholomew** - buy it today...



Sacred Living Geometry:

The Enlightened Environmental Theories of Viktor Schaubberger: **VHS Two-tape Set** - Our Price: \$39.95

Editorial Reviews: The research of Callum Coats takes us on a journey through the life and inventions of Austrian ecologist Viktor Schaubberger (1885-1958). Now, for the first time, you can view the evidence in this detailed, three-hour illustrated lecture presentation on this two video set. Viktor Schaubberger was a genius whose ideas were far ahead of his time. He worked as a "forest-master" in the Austrian Alps when they were still a true wilderness. This experience was to influence his entire life's work. Schaubberger

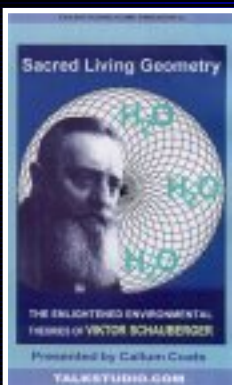

prophesied the environmental crises we are seeing today, predicting that unless we start to cherish rather than exploit our world, we would surely destroy ourselves. He demonstrated how deforestation would deplete the world of water, causing deserts and climatic chaos. Asked about our technology, "How else should it be done?" His answer was "exactly in the opposite way that it is done today!" His maxim: "Comprehend and Copy Nature!" From his precise observations of the processes of Nature, Schaubberger pioneered a completely new understanding of the nature of water as the most important life-giving and energy-empowered substance on the planet. This led him to develop a radical new science which flew in the face of conventional scientific thinking but which, today, is being increasingly recognized for its highly-relevant implications for civilization. Viktor Schaubberger might have made a career as a brilliant inventor. Forced, for a time, to develop radical new forms of propulsion for the Third Reich, he went on to work on devices utilizing the principles of implosion - hundreds of times more powerful than conventional power sources. Even in the weeks just before his death, US government and commercial interests were exerting pressure on him to reveal his secrets. Schaubberger's deep insights in the special properties of water and nature hold immense implications for future technology and ecology. **On VHS tape, two tapes.**

Universal Laws Never Before Revealed : Keely's Secrets : Understanding and Using the Science of Sympathetic by Dale Pond, Nikola Tesla, John W. Keely

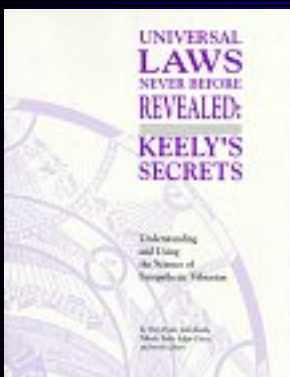

List Price: \$19.95

Our Price: **\$19.95**

What is Sympathetic Vibratory Physics? It is the science of Harmony, of Oneness. It holds the concept that all comes from One Source, One Force. It maintains that the fantastic array of things and activities throughout the universe are related in a simple manner. This simple basis of relativity is called vibration. It

has been long recognized that everything in the universe vibrates. Thus, a study of vibrations is the study of the very foundation of Nature. For once we grasp the inner functioning of the vibratory Universal Creative Forces as they operate throughout the universe, then, and only then, can we correlate them into a comprehensive paradigm and bring them into practical modes of usefulness for the benefit of mankind. Unlike dogmatic, cold science, Sympathetic Vibratory Physics does not isolate one phenomena from another but accepts and shows the inter-connectivity between all things and forces. This interconnection between all things is vibration and related vibratory phenomena. To understand vibration we must develop a comprehensive organized science of vibration governed by laws and principles. Fortunately a great deal of this development work has already been done. We have a well developed science of music. Music is an organized art and science of vibrations found within the audible range of the infinite **Electromagnetic Scale**. A major segment of **Sympathetic Vibratory Physics** is therefore a study of music, its arithmetical and philosophical basis of development and how these may be applied to procedures for inventing new and useful devices and processes. Sympathetic Vibratory Physics focuses on the inner nature of vibratory phenomena. It is well known that vibratory activity contains within itself many differing characteristics and phenomena. These include: amplitude, velocity, mode, sympathy, number and periodicity. Each of these characteristics can be regarded as independent factors as they are generally considered in conventional solutions. However in order to have validity within an integral synapses they must be considered as parts of a whole. In a holistic paradigm each of these characteristics or components

must be considered as being relative one to the others. This viewpoint is generally referred to as the Law of Relativity. No thing can be considered of and by itself as no thing in the Universe is isolated from interactions upon or by something else. The isolation of one phenomenon from all others is science's greatest mistake. Until this error in thinking and practice is corrected we will continue to experience deleterious effects of our scientific endeavors. ***Sympathetic Vibratory Physics*** gives us a broad field in which all things can be studied as relative parts of a comprehensive whole. Through the study of music and music development we have this relativistic paradigm. The fundamental principle of music is relativity. A simple frequency is nothing of and by itself. But relate that frequency to another and we instantly have two separate entities locked together by a fixed interval between them. This relationship is always expressed as a ratio or the relative values rigidly fixed in a given relationship known as an interval. Herein lies the hidden power of ***Sympathetic Vibratory Physics as developed by John Keely***. A concordant waveform, composed of harmonic frequencies, tends to pull subatomic particles together. On the other hand discordant waveforms will tend to split or explode the particle or aggregate. A simple analogy is that of dynamite, a harmonious substance when at rest, one which is held together by the molecular and atomic component frequencies. The introduction of a strong introductory impulse from a dynamite cap destroys it's homogeneous integrity and the component subatomic particles are liberated from their bonds. ***Keely explained the relationship between matter and force thusly: "There is no dividing of matter and force into two distinct terms, as they both are ONE. FORCE is liberated matter.***



amazon.com

Shop
Now &
Save

Click here

Privacy Information

Two Products That I Endorse are the "Electron 3 & 4 Living Water Machine" and the "Wellness Filter Line":



FutureTech Today introduces the Electron 3 & 4 Living Water Machine. This machine is being marketed through Future Tech Today, made by "For Health Reasons" of Chicago Illinois, USA. (makers* of quite probably the best water filtration system, based on victor Schaubberger's ideas, of coarse, on the planet!

Purer Distilled Drinking Water:

When vapor turns to rain, it passes through temperature gradients where the temperature is continually changing with oxygen. This process stretches and contracts the H bonds that hold the molecules together...this creates ENERGY! Plant diseases are caused by viruses and bacteria, and our method of autoclaving them, using INTENSE HEAT, DESTROYS THEM (NOT just boiling).

The research chemist and others spent thousands of dollars on every product on the market, and ONLY OUR METHOD prevented the diseases in plants and caused incredible growth by just dropping plant buds in the water. Root growth 2 1/2 inches long compared to 1/8 of an inch in any of the others during the same time frame...even compared to water with nutrients added to the it!! This test was REPEATED over a period of three YEARS ...so there is no mistake!. The BOTTOM LINE is that today's ordinary water is DEAD! Why would ANYBODY want to use DEAD water, and yet most people do! If you can afford the rather steep price of their units, it is well (no pun intended!) worth the price, from personal use, on my end.

*The company that originally produced this unit is listed below - "For Health Reasons" of Chicago, IL. The company SELLING (marketing) the unit is **FutureTech Today**... "Future Tech Today was founded in 1998 with ambitions to break the latest energetic healing technologies to the general public while maintaining a research and development program allowing them to bring tomorrow's technology today. The idea was to represent the latest technological research in the fields of energetic medicine, water vitality, and EMF (electro-magnetic field) protection products. They represent products and technologies from all over the world, many of which are in very early stages of production or still in research phases; in this way they give the general public a preview of technologies to come..." (from their website, and used here for endorsement sake) FDG

water-revitalizer.com

ozonedetox.com

rife.biz



FutureTech Today introduces the Wellness Filter! This is the **Wellness Filter®**, and comes in various sizes to suit individual needs. In my humble opinion - it's the best on the market, today. Pricy, but well worth it. Again, this product is offered through FutureTech, Today. For website info, use either their link - **FutureTech Today** - or <http://www.wellness.com.au> (If you go to wellness.com.au directly, you can even become an associate, an affiliate, or a partner-type program with them if you meet their strict company requirements).

"The Wellness Filter® offers you and your family a quality of water that Nature has provided to only a select few. By using natural purification processes in combination with advanced technology, the Wellness Filter® produces what many believe is the best drinking water on Earth. The Wellness Filter® not only removes harmful contaminants but it also enhances the water through a patented process that creates a quality of water beyond the reach of conventional water filters. Clean water plays a vital role in your health, fitness and appearance..." (from the FutureTech Today website).

[BACK TO INDEX](#)

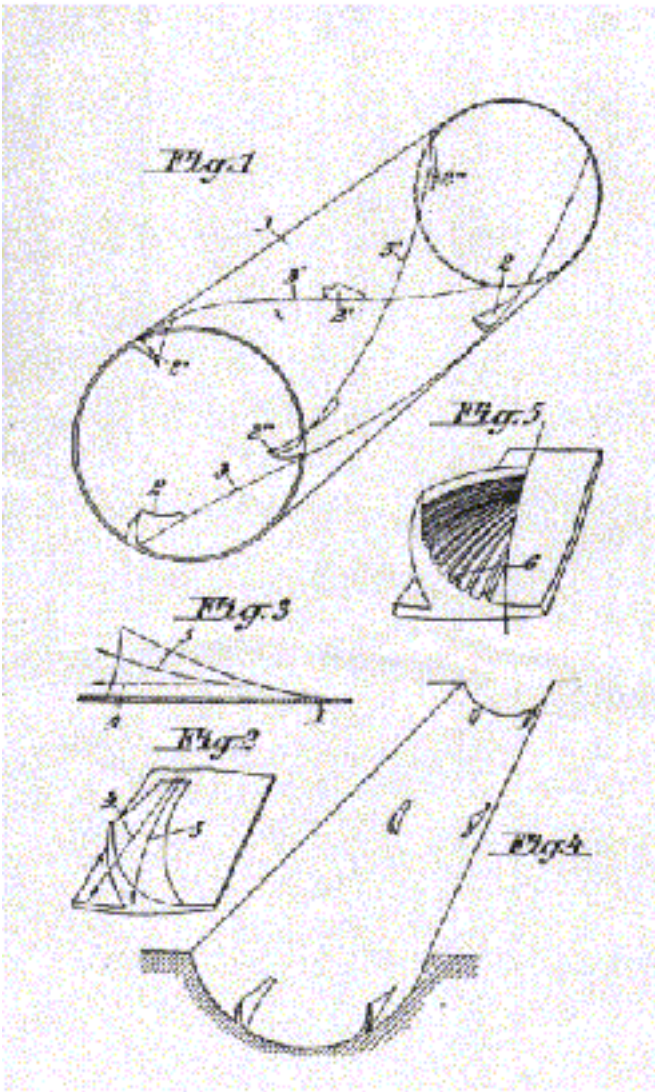



Whirlpool Power

Chapter One

The Origin of Energy

shop now

AND SAVE

amazon.com

Save big on thousands of products!

Computers
Books
Music
DVDs

Click Here

[Det levande vattnet](#)
Olof Alexandersson...



[Living Energies](#)
Callum Coats
New \$19.95!



[The Water Wizard](#)
Viktor Schauberger...
New \$12.89!



[Energy Evolution](#)
Viktor Schauberger...
New \$13.57!



[Living Energies](#)
Callum Coats
New \$17.79!



[The Fertile Earth](#)
Viktor Schauberger...
New \$13.57!



[Hidden Nature](#)
Alick Bartholomew
New \$35.00!
Used \$23.00!



[Land der Traumer](#)
Rene Freund
Used \$9.00!



[Nature As Teacher](#)
Viktor Schauberger...
New \$12.21!



(Prices May Change)
[Privacy Information](#)

Man once thought the Earth was flat and at the center of the solar system. This was a natural conclusion to come to for that is the way it appears. It still does. But we learned something in the recent expression of man's knowledge, recent meaning hundreds even thousands of years, a blink of the eye in known time of man's existence; that everything is not always the way it seems. In fact it is almost always not the way it seems.

This fact should be applied to all scientific observations because the pattern of this fact, know as "maya", is very well established. We see it in all forms of analysis of human existence and behavior. It is as if the truth is buried beneath the surface and beauty is truly only skin deep.

We have a science today of exact measurement, analysis, and everything one would think it would take to get to the bottom of things, but, we still seem to only look at the surface, take our measurements, and declare this is the way it is; not realizing we have not learned from history and repeat the same mistakes over and over again. Much like

our ancestors said the Earth is flat, it looks flat thus it is flat. Galileo found how strong a false belief is when he said the Earth was not the center of the solar system, and gave a very convincing argument only to be excommunicated and held under house arrest so he could not continue to defy the authority of his time.

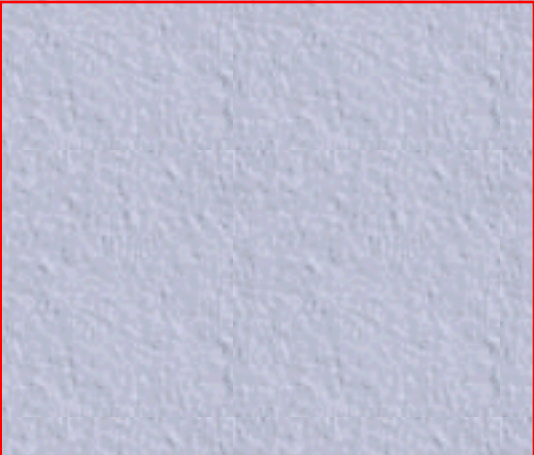

And, so it is today. But, “the times they are a changin’” as the song goes. Information is taking a quantum leap and Galileo has his day in the Sun again to challenge the false notions of surface measurements and look deeper into the mysteries of space and mind.

We have seen energy for quite some time as something related to and originating from light and heat. Our science is based on such a concept and has an enormous amount of data to back it up. Thermodynamic equations, action reaction principles all show how heat and energy are related. But something new has arisen that shines a new light on the subject, that of something called Zero Point Energy (ZPE). That energy can and does exist in the absence of light and heat.

According to science as written this should not be possible but it doesn't take an Einstein to figure it out. It is quite apparent. I will try to explain how this perspective shows energy's origin is not heat and light but gravity. Gravity is the force, the energy behind all motion, not heat and light. Speaking of Einstein, he had an idea along these lines but failing to find the proof, or the common denominator to his Unified Field Theory, the idea has almost been totally dismissed by science as a pipe dream Einstein dreamed up while puffing his pipe and pondering the grandeur of the universe.

The Pearl of Wisdom starts with a more complete understanding of the most basic action in our lives, the rain. Water is alive. We are mostly water. The action of evaporation and rain is the engine of life. Science has long stated evaporation is due the Sun; that the heat of the Sun causes evaporation. I propose a different reason. Gravity is the reason, the driving force behind evaporation and this is why.

The Sun's heat vaporizes the H₂O molecule bringing it to a higher state of vibration. This vibration expands the molecule and breaks it free from its viscous hold turning it into vapor. But there is no force of the Sun causing the vaporized molecule to rise. It is much like a scuba diver's bubble. There is no force pulling the bubble to the surface, gravity pulls the more dense water beneath the bubble and pushes it to the surface. The same with evaporation. There is no force from the Sun pulling the water molecule up.

Gravity pulls the more dense atmosphere beneath the vaporized H₂O molecule and pushes it to the clouds. That happens as we know in a high pressure system, and conversely in a low pressure system gravity pulls the more dense H₂O beneath the less

dense atmosphere to make the rain. This gravity pump is the energy that drives the process, not the light from the Sun.

That is the first step in understanding The Pearl of Wisdom and that Pearl is as abundant as the rain. We think of heat and light as energy but that is just a surface observation. The Sun actually does the same thing to the photon as the Earth does to the water molecule. The gravity of the Sun pulls the more dense space beneath the less dense photon and pushes it outward. The photon is really the ultimate void. Space on the other hand is much more dense. Science has debated this point back and forth for a long time, but never have they seen the simplicity of the Pearl of Wisdom. The photon is just riding on that "old gravity train" a train that really just jiggles, vibrates, and passes the photon along while the space itself does not move but just the amount needed to move each photon. In saying photon it would be best to say it is like the space between the waves at the ocean. This space moves between the crests of the waves while the ocean basically stays in the same position. And the same with the atmosphere. It does not ride with the H₂O molecule it just passes the molecule up like a bucket brigade, that "old gravity train", with gravity as the engine.

One might argue that without the heat and light none of this would take place. This is true to an extent, and an analogy can be made that the Earth needs to be large enough to look flat to be round, but in that argument the point is missed. The Origin of Energy is gravity not heat. Heat exists due to gravity, gravity can exist without heat. It is the gravity that is the origin not the heat and light. It takes the gravity to apply the pressure needed to ignite a star in the first place. And gravity and energy can exist in the absence of heat and light but the converse is not true; heat and light cannot exist without gravity. It would be very possible for a system of un-ignited stars or planets to circle around a black hole far away from our known universe and have an enormous amount of energy without any heat or light if they were too small to have enough pressure to ignite. Recent research has shown the frame dragging effect of rotating objects does exist. This was just a theory for many years and thought to be invalid. And the measurements are much higher than expected.

I think the frame dragging effect is doing far more than science currently understands, and will go into more detail in the next chapter on Whirlpower Theory.

We can actually see the wiggle, the wobble, the jiggle, of gravity pulling on the fabric of space in the twinkle of a star. The twinkle is the vibration of gravity pulling the space beneath the photon when it slams back together. One could make the analogy to thunder; gravity pulls the atmosphere back after a lightning strike. And speaking of lightning it too has its origin of energy from gravity, that is why it is said to travel from the ground up instead of coming down from the sky. The void is opened and gravity pushes the less dense negative charge up that connects to the positive charge and the electrons balance with the flash. This creates a click sound. Then gravity closes the void

pulling the more dense exchange of positive charges down. As it closes, the door slams, and - boom - the classic thunder clap is heard. Tests in Zero Point Energy research show florescent type light can be turned on and off with a measured amount of energy. Then the sound energy is measured and is larger than the energy put in to turn it on. If the thunder of lightning were measured in energy and compared to the energy of heat and light in the lightning I think it would show the same higher measurement. I have not heard of the experiment being tried or theorized.

All this is not to say light and heat don't have energy. They contain energy just like science understands as far as I can tell. It is the origin of this energy this theory tries to express.

One might say, you can shine a flashlight against this outward push of gravity that proves gravity is not the origin. I think an experiment of this sort would show the intensity of a flashlight shining up measured over distance would be brighter than the same flashlight shining down, and is the reason a candle flame goes up. The energy contained in light can beam itself against this outward push of gravity, when coherent (as in the laser) it can blast through solids, but in its ultimate origin gravity is the reason, and the energy behind its travel through space.

Like in a centrifuge, but reverse in motion, it is going to be hard to stop the less dense material from moving to the center because the more dense is moving outward.

There have been great strides in the understanding of The Origin of Energy by science I have just found out about in recent weeks. Although I have been speaking about this for quite sometime my theory has been scorned and I have suffered ridicule because I do not have proof of these ideas. I am very glad to finally be seeing science is also coming to an understanding of gravity and I hope the work of some of these scientists will allow a further and more in-depth review of this work. I have most recently discussed this with some of the prominent scientists in this field, and learned of their work. Although it appears to be in it's infancy and does not have the full understanding of the Pearl of Wisdom, it is much further along than my college days 20 years ago.

Recently I had the opportunity to discuss my ideas with scientists on Bill Beaty's vortex list that has a number of new energy scientists working on Zero Point Energy. Including Hal Puthoff, whose work has proven Zero Point Energy is viable and not in violation of the laws of physics. During this introduction initially I was treated with skepticism but eventually made a few points with the group and learned for sure my approach is unique and un-theorized in it's completeness before. My version of evaporation is unique, my version of the motion of light and heat is unique. I have yet to receive acknowledgment from these scientists as they have not yet reached the full understanding of the Pearl of Wisdom, but they are much closer and are at the brink of understanding. This work can be seen in the archive of; <http://www.eskimo.com/billb/weird/wvort.html> , and also in an

active archive at the Science and Spirituality list at Spiritweb, I have a running chronicle of this work going back for over a year. Here I introduced my Whirlpower Theory (which is in the next chapter) and built the comprehensive and cohesive theory of gravitational energy and a unified field theory leading to the Pearl Of Wisdom and The Origin of Energy. My theory starts out simple inspired from a dream I had about a giant whirlpool being used to generate electricity. This work can be seen at; <http://www.spiritweb.org/cgi/ml.cgi?list=science-l&passwd=devotion>

Chapter Two

Whirlpower Theory

The whirlpool, something most never think about, fascinated Aristotle. He even threw himself in one because he could not figure it out. And it is something used all the time as a symbol to catch people's attention. The spiral symbol carries a powerful symbolic message of appeal known well to advertisers and the media. During the past year I have noted a constant stream of whirlpool and vortex imagery used in many arenas. But where is the whirlpool?

This became one of my first questions as I began my research a few years ago on the information about whirlpools. I found out very quickly there was none. No scientific data of any kind on a whirlpool available. But I found an enormous amount on the vortex.

People had built them and tried to tap them for energy. Interesting; I was looking for information about building a whirlpool and taping it for energy, but no whirlpool found. There was only a scant obscure reference about the eddy vortex and the bathtub drain vortex. Nothing was said about putting the two together. Nothing written on what I called the Compound Vortex.

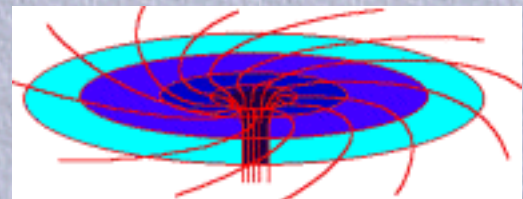

Whirlpower Theory is a very simple theory. The very basics of it say a whirlpool can be built in such a way as to generate electricity, and that the energy comes from gravity. Gravity is not recognized as energy in the classic sense to standard science. But, the new forefront of scientific ZPE shows that there is proof that gravity is energy, just like Einstein predicted.

If a whirlpool is built with a compound vortex, meaning a broad wide eddy type vortex coming from outside push, and the small simple bathtub drain type vortex from inward

pull, the giant whirlpool is constructed. It most likely has never existed naturally in nature. The closest thing nature provides as a model is the hurricane. And the difference in the tornado and the hurricane is the closest thing I have found in the difference of past vortex research and Whirlpower Theory. Scientists have built tornado wind tunnel type vortexes and measured them but I have found no evidence of building a hurricane type vortex and measuring it.

The biggest mistake I see in vortex science is thinking the vortex can be tapped. Even taking a measurement of its power reduces the power more than the measurement taken. This is part of the heart of relativity science as to observation and measurement actually changing what is being observed and measured. That is what makes everything relative. It is much like snuffing out a flame trying to measure the heat. In Whirlpower Theory it is stated the vortex must not be disturbed. The part of the whirlpool tapped for energy comes from the action of gravity on the vortex, not the vortex itself. Gravity causes the vortex to wiggle, wobble, jiggle; now we have heard these words before, in the Origin of Energy, in ZPE.

It is the same thing. The wobble of the vortex causes a dragging effect on the water surrounding the vortex. This current of water, donut in shape, goes round and round but does not go through the vortex. They are two different systems. This effect in space is called frame dragging and was just recently proven, although theorized long ago. Several studies and a couple of frame dragging theories currently under study by science still leaves much of this action unexplained. The reason is science does not have the basic understanding of gravitational energy and does not recognize the wobble as the driving force in frame dragging. They think it is the rotation. They do not understand that the black hole wobbles. This misconception permeates all of science.

It is also evident in the explanation of the motion of the Moon around the Earth. Conventional science explains the motion of the Moon as coming from the Moon. It is said the Moon causes the tides and the tides then cause the motion of the Moon. I think the wobble of the Earth causes the tides and this wobble frame drags the Moon. Just to think the gravity of the Moon is strong enough to override the gravity of the Earth and move the oceans and then have enough energy left over to make the Moon go around the Earth and add to its radial orbit breaks every law of physics in the book. Not to mention that the wobble of the Earth is not even considered in the equation when the wobble moves trillions upon trillions more mass than the tides do. The wobble moves the entire Earth. So really what we have here is a traditional science theory based on a perpetual motion concept relating to the motion of the Moon. With this false theory as part of basic traditional science it distorts all of science. This is much like thinking the Sun went around the Earth. When such a basic concept is wrong but accepted by traditional science it throws all of science off. And that is why science cannot explain things like tornadoes and hurricanes. But it goes even deeper than that. The Sun

wobbles and its frame drags the planets. And to top it off, the more dense core of the galaxy, complete with black holes, wobbles and frame drags the bulk of the galaxy including the Sun and solar system.

A recent study by astronomer Vera Rubin shows there is an unaccounted for 90% motion of energy in spiral galaxies she has observed and measured for 30 years. This study shows traditional science has not been seeing 90% of the picture relating to energy and is said to be a study that will change the scope of science forever. She does not say she knows what is actually happening. Theories have been thrown up referring to anti-matter and mysterious dark matter. I think it is Whirlpower. The spiral galaxies, including our own Milky Way galaxy work just like a whirlpool. And so does the hurricane. And this is also why science does not understand the awesome power of the hurricane. They do not understand the "gravity of the situation".

It is very important we get to the bottom of all of this because we need a clean energy source for our planet if we are to survive. Time is of the essence. Many times, I am asked "where is the proof?" I am told, "don't talk about - it just build it," and that is exactly what I would like to do; build it. And if it works, that will be the proof. It will explain so many things that appear to me a pattern of unexplained things. It is that pattern of unexplained things that makes me think this will work. My theory is not from scientific answers but the lack of scientific answers to many different questions relating to the spiral motion of things. From the toy top, the whirlpool, the tornado, the hurricane, the solar system, to the galaxy, there is a common thread of mystery; and with that common thread of mystery this theory is built, and with inspiration from my dreams.

The most exciting part to me is that it is provable by building a Whirlpower machine. This involves building the biggest whirlpool possible, as wide as possible with a strong vortex getting as much wobble going as possible. What these parameters are, and does it need to be large to work, are questions only scientific analysis and experimentation can bring answers to. I don't think a miniature model would be the best approach since we are working with gravity. It might be like making a miniature solar dish, a miniature windmill, etc. It needs to be of a scale proportional to its need to some extent. It would be a shame to build a tiny one that did not work because it was not large enough to use the mass effectively. Almost like building a miniature automobile complete with a tiny gas motor would be harder than building a larger one.

By pumping water out of the center and back in at the perimeter creating the compound vortex, Whirlpower is set in motion, much like starting a gasoline motor it must be in

motion before it will run. When the vortex/feedback loop system is running and the wobble of the vortex sets the donut system into action due to the force of gravity, energy from gravity can be extracted to maintain the vortex/feedback loop system. I think the donut system will contain 90% of the mass of the system. The vortex/feedback loop will contain

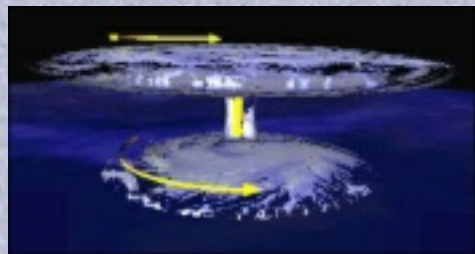

10% of the mass. The speed throughout the system will vary but not a lot with the highest speed most likely near the center of the vortex/feedback loop system, midway between the center of the whirlpool and the outer perimeter, much like the hurricane. The hurricane is the model I am trying to replicate in the whirlpool, and if I can, it should have the same unexplainable energy found in nature. But it will no longer be unexplained - it will be Whirlpower.

I hope this theory will reach those that can help me find answers to these questions and help me build a whirlpool and test it. Just the fact one has never been built and tested appears to me as an enormous exploration gap into something that should have already been tested, if not for energy extraction, but for a more basic understanding of hurricane and vortex science; that seems to be completely in the dark as to the explanation of these most powerful forces of nature.

I say, for flight, look to the bird; For power, look to the hurricane.

If Whirlpower is proven there are many other forms it can take. Many I have explained in the on-line work I have done and I am sure there are untold spin-offs yet to come. If Whirlpower is proven, the knowledge of it alone will lead to an energy revolution since the technology is so simple. It will not take expensive high tech gadgets to apply the concept to practical application. It can provide an economic boost to any poor and working man who wants to apply it. Having a clean power source will be as simple as putting in a fountain with basic plumber and electrician skills. Kits could be assembled that almost any handyman could build. All it takes to find out is to build the whirlpool. It will take thousands to find out, but not millions.

Chapter Three

The Holy Grail

amazon.com
and you're done.™

Shop
Now &
Save

Click here

Privacy Information

- [Electronics](#)
- [Books](#)
- [Music](#)
- [DVD](#)
- [Video](#)
- [Toys & Games](#)
- [Today's Deals](#)
- [Kitchen & Housewares](#)
- [Tools & Hardware](#)
- [Computer & Video Games](#)
- [Outdoor Living](#)
- [Apparel & Accessories](#)
- [Camera & Photo](#)
- [More...](#)

ZPE (Zero Point Energy) is said by the DOE (Department of Energy) to be the Holy Grail of energy research. I think Whirlpower is the Holy Grail. In mythology the Holy Grail is something that man searches for in a number of epic adventures. It is said to be almost impossible to find. Like looking for a needle in a haystack full of needles. One analogy I have made in my work is it is like looking for the missing puzzle piece in a giant jigsaw puzzle with nothing but blue sky. You have to look for the negative shape of the missing piece, not the piece itself.

There is also the spiritual aspect, Holy Grail meaning something that relates to God. So really what we get is a scientific and spiritual understanding in learning what the Holy Grail is to start with and what it does as it relates to the connection between God and Man. It is obvious something is wrong on Earth with this most important scientific and spiritual understanding of the truth.

In spiritual terms there is something known as the Tao. The Tao means the way things work, or more simply, "the Way". A concept of wisdom called Taoism is known throughout the world but is not seen as a religion in the classical sense. We also know in the Judeo-Christian world of the story of eating the fruit of the Tree of Knowledge of Good and Evil. Both of these concepts of the forces of positive and negative, and the knowledge thereof lead to the understanding of these most elemental forces, and that understanding leads to wisdom; and I think the Pearl of Wisdom, of which, now, you are reading.

Plus, all of this has come to me in such a way as to intuit this theory more than by coming to it in terms of scientific analysis and experimentation. Dreams have played a major role in its development and plain old common sense. That, plus looking for what is not known just as much as what is known has helped me put the puzzle pieces together.

The symbol of the Tao can be plainly seen in the hurricane and was one of my earliest and most important clues. But I was well into my theory before it became evident the Tao, the Knowledge of Good and Evil, and the hurricane, are related in this most amazing puzzle. In my dreams I was able to tame the “beast”, the tempest, and caught the tornado, miniaturized it, and held it in my hand. And may I say, once you have held a tornado it gives one a better understanding of the vortex. Plus, I saw a giant whirlpool in my dream and was overwhelmed with its awesome power and glory. Then by process of discovery and study I learned about what has been tried and what hasn't been tried in science along these lines. The missing piece turned out to be the whirlpool. Plus science has never been able to explain the hurricane and it was just announced in prime-time on TV that almost everything science once thought to be true about the vortex has just this past year been proven to be wrong. And that science needs to go back to the drawing board and start all over.

The Holy Grail has been presented to the world as Whirlpower Theory and is a gift. This means everyone should be able to use it for their own betterment, not controlled as a monopoly by any person (including myself), company or country. I think this is most important. It can give many people, not just the rich a way to help the economy, and of course will be a nonpolluting source of energy.

There is more to the Holy Grail than just Whirlpower. Many of my inventions have an element of this type of thought. It is my hope to one day be able to bring more of my work in the world. As it stands now I am just one man, not a company or organization, nor am I backed by any money, nor do I have to answer to any board of advisors. I hope, once funded for research, I will be able to continue this research and build a Whirlpower machine. I have just secured www.whirlpower.cc for this purpose and will place all my information, news updates, building procedures and results for full scrutiny by interested parties. When completed, individuals, companies, countries, would all have the right to implement my theory into their systems free of charge under public domain. I will however express to any of those who want to remember and want to give what they wish, such money will go to into my organization dedicated to the discoveries of the mysteries of space and mind.

We are told by many we are entering the “New Age of Aquarius”. Aquarius is denoted in Astrology (the old world mix of astronomy and religion) as the water bearer, of a being holding a water vessel and pouring out water as a stream of stars. If the twinkle of a star is caused by the quantum jiggle of ZPE, and it is that same gravitational energy behind

the driving force of Whirlpower in the wiggle, the wobble of the vortex; then the analogy is astounding in the scientific/spiritual cosmology of the Holy Grail.

In addition, Ezekiel's Wheel has a number of interrelated spiritual symbolic references I have noted in my dream-work. As a lucid dreamer, much of my work is done on this concept in my REM state of sleep. I am what is known as a conscious dreamer. I maintain consciousness in REM state and thus have more memory and control of the dreaming process. Stanford University is noted as a leading researcher of this type of now recognized valid occurrence. They have been in contact with me and have asked me to participate in their research. After I finish my work with Whirlpower I may decide to work with Stanford in these matters. I feel the subject has definite scientific validity and with the proof of Whirlpower Theory I hope my story will give greater credibility, understanding, and wisdom to their research.

I hope those reading this will give this the utmost of consideration and give this work a thorough and fair analysis. I have stated all I know in the clearest and most concise, truthful manner I know how to regarding this most wondrous of possibilities. I give the highest credit to God and my dreams, for the inspiration, and the strength, to get to this point; to have dreamed the impossible dream.

Chapter Four

Whirlpower: The Machine

In this chapter I will try to explain Whirlpower, The Machine. The Whirlpower concept can be applied many ways, but in this chapter I will try and focus on a basic way to use the whirlpool.

WHIRLPOWER THE MACHINE



In the first Whirlpower picture you see a tank of water. This tank can be of any size but the larger the better and it may be that it has to be of a certain size or larger to work. I suggest we start in thinking of it as 30' across and 10' deep. It is very important to be as wide as possible to get the full eddy effect. My research has shown this approach is different than that other vortex or wind "tunnel" types of vortex energy theories. In Whirlpower we are trying to tap the gravitational effect on

the vortex, not the vortex itself.

In the water is a wheel with fins. This is referred to as "the big wheel". It sits in the torus donut and turns with the current and does not touch the vortex. It connects to a number of wheels on the perimeter that turn the pumps and generators. There should be at least two and in most cases more, especially the bigger it is built. This connection can be simple. The big wheel just rides on the little wheels that are in a fixed position in the water and turns an axle to another wheel outside the tank. It is possible for the pumps and generators to be in the water but I think it would be easier to maintain outside.

The entire system is started by turning the wheels on the outside and setting the pumps and big wheel in motion. Once the vortex forms and the torus donut is at the right speed power input can change to power output. It will then sustain itself and generate electricity by the force of gravity acting on the vortex causing it to precess.

We usually don't think of a vortex precessing since it is fluid not solid. This is why Whirlpower has remained hidden all these years. But as we know the faster water goes the more it acts like a solid, much like hitting water at a high speed is similar to hitting the ground, be it falling airplane or skydiver or distraught bridge jumper.

So it is this precession force due to gravity that is the driving force in Whirlpower. But the whirlpool must be built in order to bring this force to life, so to speak.

The next picture shows a little more detail and overview and compares the compound vortex to the torus donut. This is what it all comes down to. Is the mass and speed of the

torus donut more than the mass and speed of the compound vortex?

And is this difference enough to sustain the system and generate electricity and do work? All my research shows it will and is the same force that drives the hurricane and the planets and the stars. Beautiful simplicity in motion.

This next picture is of the Holy Grail. This is the Golden Chalice. It is still Whirlpower but the donut is compressed by the shape of the bowl allowing for the width needed for the eddy and fits the hardware. I think this may also be what was once known as Hero's Fountain and has been done before but the knowledge was lost over the centuries.

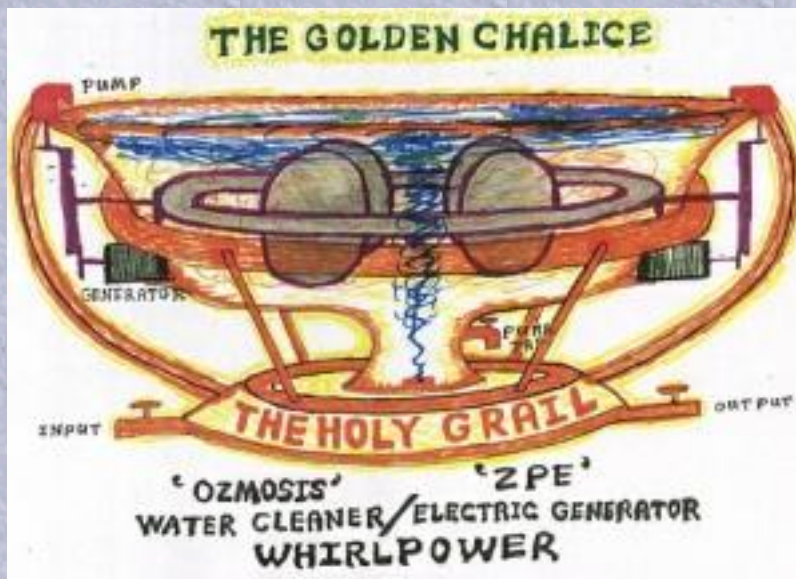
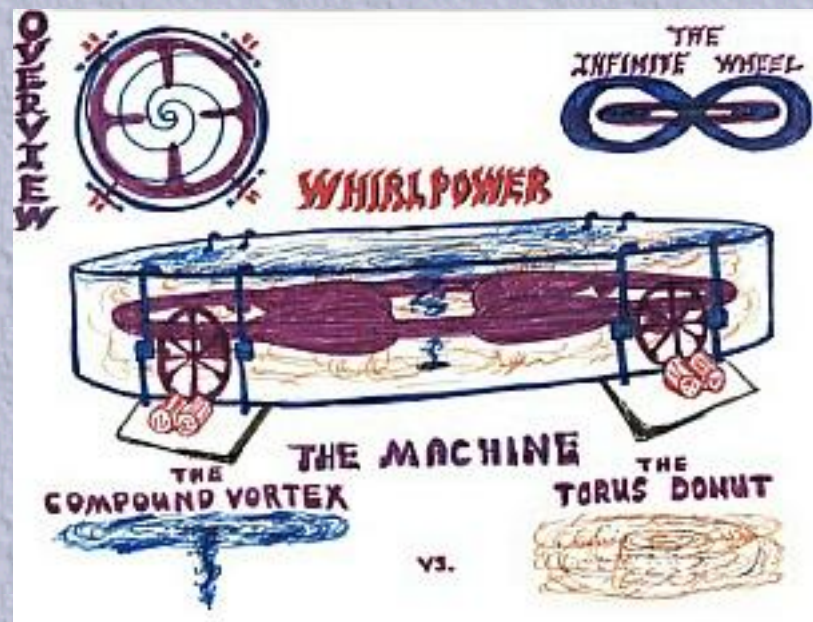

It has the Osmosis Water Cleaner shown. This system made of gold would not corrode over time and would be perfect for small home systems that would provide clean water by the centrifugal force. The heavier particulates would go to the outside and drain off slowly through the output. It could be hooked up to any water system. Stainless steel would probably be the best choice in a practical sense but gold or gold plate may still prove to be the best.

In the next chapter I will show variations on the theme and a number of other ways the Whirlpower concept can be used.

More acknowledgements: I want to thank Dan Winter, <http://www.danwinter.com> (this link may be obsolete) for being one of the first to recognize the possibility of Whirlpower and making the connection to his work on Sacred Geometry. His definitive text is a masterpiece and I think it relates to the kind of actions Whirlpower and related works I have in progress are based on. I think Dan and I will eventually work out the mathematical formula of these actions using his phi based Geometry.

I want to thank Curt Hallberg of the Malmo Group in Sweden. His keen perception of the similarity of my work and the work of Viktor Schauberger's long ago has been very helpful. Curt hopes to test the Whirlpower concept soon. Curt has a test of principle

example of Whirlpower in his earlier work of a water cleaning devise that has similar Whirlpower properties. Test of principle model: <http://home5.swipnet.se/~w-58759/energy/whirpow/Whirlpower.html>

The Beginning

by David Dennard

What is Whirlpower?

Whirlpower is a gravitational force of spinning mass. While spinning a charge makes an additional magnetic force, spinning mass makes an additional gravitational force. The greater the wobble the more it will affect its surrounding area. All spinning objects wobble be it ever so great or small. It acts like a lever as far as how gravity affects the area around a spinning mass.

When the hurricane gets big and fast enough, the eye wall wobbles and pulls the hurricane. This acceleration is Whirlpower.

The debris field kicked up by the tornado that picks up huge objects like cars, houses, the infamous flying cows, etc., is the effect of the spinning vortex on its surrounding area. This effect is Whirlpower.

When a neutron star spins at 300 revolutions per second it causes matter to spin around it in orbit at 1,000 revolutions per second. That acceleration is Whirlpower. A black hole frame drags gas around it, and it is “wobbling like a child’s toy top as it slows its spin and begins to teeter in all directions” (quote from Kathy Sawyer, the Washington Post). The Earth spins and wobbles. This action pulls on the Moon increasing its orbital radius. This increase is Whirlpower.

The sun spins and the wobble drives the planets - Whirlpower. The Galaxy spins like a giant hurricane, the dense core wobbles and the stars proceed. Need I say more?

Of course; and I have to keep saying it till we build the whirlpool. The hurricane is said to be the most mysterious event in nature. It was announced on the news recently that “almost everything science had thought to be true about the vortex before, was wrong”!

Now you don't have to be an Einstein to see a pattern starting to develop. If you read my theory in detail and look at my "childish sketches", I describe a machine that can use Whirlpower to generate electricity and clean water.

We need Whirlpower NOW!

Whirlpower is about gravity being "The Force" and how that force works. It is the Phoenix, Tao of Eagle, the "Way" things work, the principle of flight, the power of the hurricane, the driving force of the Universe. It is opening the void. Density displacement; Motion due to gravity.

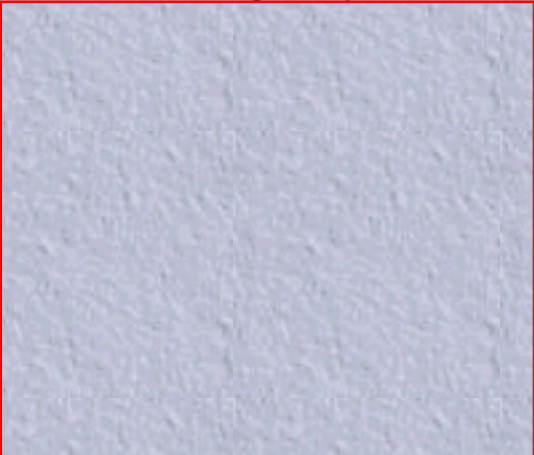

Gravity is like the balance of the scale, it will always try to balance. It causes the motion by pulling on the more dense thus pushing away the less dense. It attempts to find density displacement balance. The heat carried in the void is real, but it is not the origin. Understanding this leads to understanding how gravity really works and how a machine can be made to harness this force.

Whirlpower is one of many design concepts that can harness the force of gravity. It is simple and easy to understand once you understand "Pearl of Wisdom". If you think it is creating energy then you don't understand Whirlpower. It is not free energy any more that solar, wind or hydro. Actually all energy is given freely by nature but there is no "free energy". It all comes from "The Force" of gravity. Whirlpower is "The Way" (The Tao) to follow the pattern nature provides and make a "full circle system".

The essence of the Whirlpower system is that the rotating axis of a free rotating structure will not be precisely vertical but it will deviate randomly under the influence of gravitational forces. This "wobble behavior" of the rotating structure has a dragging effect on the surrounding substance (be it a liquid or gas), which will start to rotate also. The rotation of this surrounding substance can be mechanically transformed into energy, without affecting the originating rotating structure.

When the energy contained by the mass and speed of the surrounding substance becomes much greater than the energy that is needed to keep the center rotating structure moving, one can get more energy out of the system than has to be put in. This energy is not created out of nowhere, but it originates from the gravitational forces on the center rotating structure. In the Whirlpower system, the free center rotating structure is the vortex, tornado or hurricane. This vortex is kept going by pumping a small amount from its base back up to the perimeter of its top. The drag of the wobble of the vortex causes the surrounding fluid or gas to rotate. By placing a wheel with fins in this surrounding fluid or gas, energy can be extracted from the system. The belief is that the energy needed to pump up the fluid or gas is less than the rotation energy that is being

stored in the surrounding fluid or gas.

Whirlpower

Electric power produced by a whirlpool/whirlwind

Concept

In David Dennard's own words: (May 5, 1998) - "Whirlpower is now in its 20th year. It has been in its present form since 1995, and has been through numerous changes. The current state of the art is now evolved to a point of discussion and analysis."

"There are many things in nature that point to Whirlpower. The form of the vortex is shown in a multitude of places. It seems an obvious place to explore for power. Many have, it seems, looked down this road only to leave disappointed. What appears to be obvious is well hidden and what is hidden is in plain sight."

"The main argument against Whirlpower is and has been that it is perpetual motion, that it cannot produce more power than it takes to maintain the system. This argument does not take into consideration the force of gravity nor does it consider gravity a viable force that can be tapped in the system. All arguments so far have been based on the perpetual motion premise, the action-reaction principle, and the conservation of energy equation. If gravity is not considered of a possible form of energy, Whirlpower is impossible. Those who will not consider gravity as a form of power do not argue the same points as I propose and have yet to argue the basic math of the system."

"Gravity is accepted as a viable form of power in our hydroelectric technology and our understanding of the power in falling water due to gravity. ***The concept of rotating water due to the force of gravity is the idea behind Whirlpower.*** This rotation is a secondary force of gravity resultant to the spin of an object. In massive objects in space this effect is known as frame dragging. In smaller objects within a gravitational field and in a fluid this effect is currently unknown to science."

"I am trying to introduce this effect to science and the world as Whirlpower. So far, many have said they think it is possible I am right, but most say I am wrong, and so far it is not recognized. It is difficult to find analysis, much less acceptance, since I am not in the

scientific community and have no credentials in this area. My approach to this is dream inspired.”

”When an object spins, it wiggles, be it ever so slight. When an object spins, and it is of a certain size and weight, this wiggle becomes a wobble and is known as **precession**. Large massive objects do this while spinning in space and small round top-like, funnel shaped, and gyroscope type objects do this in a gravitational field while spinning on their axis. This includes high speed fluid objects like the tornado and the hurricane. Since the speed and mass of the moisture and air create a compression hydraulic affect, these high speed spinning objects, while being fluid, begin to act like a solid object and exhibit gyroscopic like actions. These action can be seen in the wobble of vortex of tornadoes and the radial arms of the hurricane. This action is due to gravity acting on the vortex like a solid causing it to **precess**. In the hurricane this precession is most pronounced and its shape is most like a gyroscope. The tornado does not **precess** as much because it is a simple vortex and is not as “top” heavy as the hurricane.”

”This difference appears to be the difference in the Whirlpower approach to this subject as compared to others who have tried to tap the power of the vortex. This precessional force, under the right circumstances, can be considerable. Just like, at the right speed, a top or a gyroscope will **precess** in a remarkable way just before it slows down and falls over. In Whirlpower this action is held in continuation by adding energy to the spin and maintaining the rate of precession and spin, instead of letting it slow down and fall over. In a high speed spinning fluid object this is done by pumping fluid in a feedback loop from the bottom of the vortex back to the top of the whirlpool perimeter.”

”It is important to understand the fluid is not pumped directly back into the vortex, but into the whirlpool from the widest perimeter possible to get the eddy effect. This compression type vortex added to the suction type vortex made by the pull on the water through the pipe under water makes the compound vortex. This compound vortex is the secret to Whirlpower. It has much more precession than the simple vortex because it has a much larger top and acts more like a gyroscope.”

”***This precession of the vortex leads to procession.*** The precession pulls water around in the whirlpool that does not go through the feedback loop or the vortex. This current of water is donut shaped and flows around the vortex in the bell curve of the cornucopia shaped funnel. It is this current of water that is driven by the force of gravity. When the speed and mass of the whirlpool reach the proper amounts and the precession is at the right frequency, the speed and mass of the donut shaped processional current appears to be more powerful than the speed and mass of the water needed to maintain the whirlpool.”

"This is the Whirlpower Theory. It is not mathematical in basis but conceptual. I hope this concept will lead to a mathematical analysis and prototype. (...) This is scientific evolution. Seeing things as part of a whole system, seeing the similarities, not just the differences."

"Whirlpower is the concept. It is the force of the procession induced by the precession of a spinning object. In the case of the vortex and Whirlpower in a fluid, the main piece of hardware is the Big Wheel. This wheel moves with the donut shaped current of water or air, and is just a big. It is not a paddle wheel with just one part connecting to this current but it is in the current and part of the current."

"Since the power being tapped comes from the **precessional** action of the vortex, this force cannot actually be harnessed by direct contact, but by induction. This way the spin of the object is not disturbed, in this case, the vortex. The **precessional** force is tapped by induction, not by direct contact. The Big Wheel is placed into the whirlpool or whirlwind in such a way as **not to contact the vortex directly. It is hollow in the middle with fins reaching in from the rim up to but not into the vortex.**"

"This concept of power coming from the induction by the precession appears to be the difference in the Whirlpower Theory and other vortex theories. Others have recognized the possibility of power but when they went to tap it they "snuffed it out", much like snuffing out a flame. I submit this power is known and calculated but efforts to measure it have resulted in killing the exact power being measured. (...)"

"Pipes, pumps, and generators make up the rest of the Whirlpower hardware. They connect to the Big Wheel at the perimeter of the whirlpool or whirlwind. The pumps pull the water (or air) through the pipes, creating the simple suction vortex, and pump water (or air) into the perimeter of the whirlpool, creating the eddy compression vortex. Together, this is the compound vortex. All of this must be "started", much like must motors, but once in motion the Big Wheel will supply all the needed power from the force of gravity. Whirlpower harnesses the force of gravity."

(June 17, 1998): "When I first proposed Whirlpower on the internet I had no knowledge of all the previous work in the area but I soon learned of the fascination with the vortex and its history. I was constantly struck how similar but different my theory was compared

to all the rest. My theory is about a giant whirlpool, the rest seem to be about the vortex itself.”

”It seems science knows about the possibility of energy using a vortex but just has not been able to get a grip on the subject. They have tried but only succeeded in gripping the vortex and snuffing out the power. The vortex is a lot like a flame. It can’t be contained to collect its energy. It must “burn” freely and not be restrained. The vortex, “the fire of the Kundalin”, has energy but it is not in the vortex. The energy is in the wiggle, which comes from the force of gravity acting upon the vortex. **This wiggle, is the precession of the vortex. It causes the vortex to wrap time, space, and anything else, around the vortex. This is known as frame dragging.**”

”Most cases of frame dragging do not lead to a tap-able energy source because the frame dragging effect is not large enough to tap without cutting in to the spin. For example, you can’t just grab a hold of a processing gyroscope and expect to get energy. This is similar to trying to tap the precession of the simple vortex as theorized or attempted by all my predecessors. **Tapping the precession “snuffs out” the power. Only the frame dragging effect, or what I call the procession can be tapped.**”

Whirlpower:

Electric power produced by a whirlpool/whirlwind

Declaration

After timely debate, and in the presence of corroborating evidence, albeit circumstantial and synchronistic, and in the absence of disproof; I present the Whirlpower Declaration.

This is a declaration of the logical possibility and the sufficient evidence for Whirlpower to be considered as a source of power and an explanation of the acknowledged and unexplained observable reality of the mystery of the hurricane.

This information is given freely into public domain because this knowledge could never and should never be controlled as a monopoly or absolute power, but as something anyone may utilize for their own betterment and the betterment of life for all.

Furthermore, it is a reservation of the right to Free Speech and Freedom of Information.

If Whirlpower is proven and this knowledge leads to “windfall” gains to any group, organization, or individual who may wish to remember and reciprocate with a donation or love offering, all such will be put into a non-profit, public organization dedicated to the understanding of the mysteries of space and mind.

Whirlpower:

Electric power produced by a whirlpool/whirlwind

Theory

In David Dennard’s own words: “Whirlpower is the power of the gravitational force upon a spinning object. This power is the rotational procession of a spinning object. It is

seen in all spinning objects from to simple toy top, the simple vortex, the gyroscope, the whirlpool eddy, the whirlwind, the tornado, to the more complex

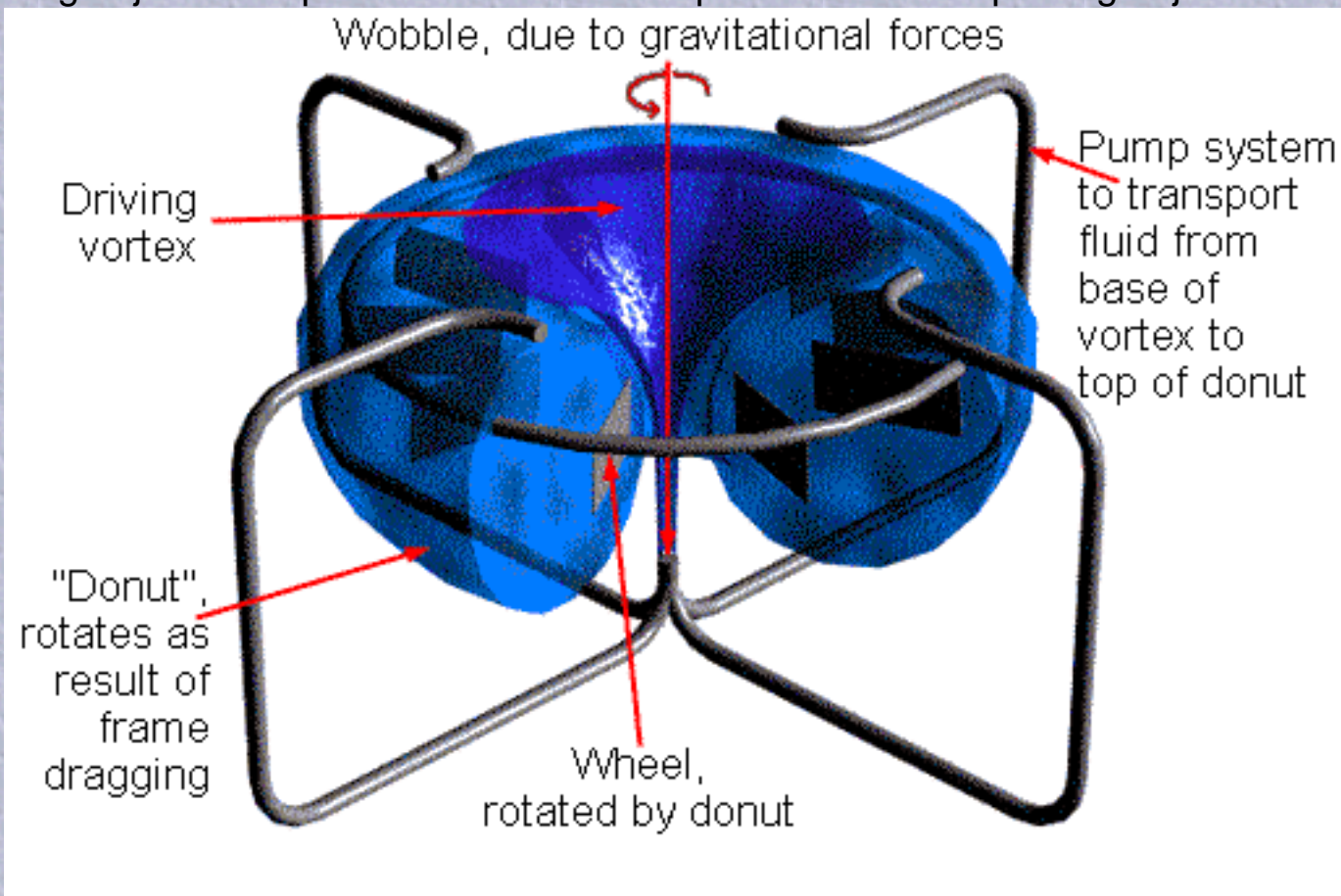

frame dragging rotation of the moon around the earth, the rotation of the planets around the sun, the motion of the universe, the black hole, and to the most complex; the compound vortex and the hurricane.”

”The application of this form of power in a devise that produces electricity can be accomplished by building an artificial hurricane. This whirlwind (or whirlpool if done with water) is made by pumping air through ducts making a feed-back loop from the vortex to the perimeter of the whirlwind in such a way as to create the compound vortex. This hurricane like whirlwind then turns a large wheel placed in the whirlwind, turning with the whirlwind, but NOT in direct contact with the vortex. It turns with the current of spinning air created by the frame dragging aspect of the large powerful spinning compound vortex.”

”The big wheel has fins that reach in but not into the vortex, and fits into the bell shaped curve of cornucopia shaped compound vortex. This wheel turns the generators and pumps once the system is set in motion. If proven, the power of the big wheel will be greater than the power needed to drive the pumps. This power comes from the force of gravity acting on the spinning vortex creating the precession of the vortex and the resultant frame dragging of the whirlwind.” David Dennard's original site is at <http://www.whirlpower.cc> .

My compliments to Mr. David Dennard for presenting this excellent theory freely to the world. I have done preliminary study on his theories and have come to the conclusion that it does, in fact, merit further research. My company, International Turbine & Power, LLC, will attempt to build and replicate these theories with and actual functioning unit. I will post the results to this website when the unit has been tested. Since this theory fits right into the already established doctrine of Viktor Schauburger, I feel that we just may have a working “Whirlpower” machine in the very near future. Rest in peace, Mr. Dennard...your work will not be forgotten. FDG

[Back to INDEX of Frank.Germano.com](#)

[Back to the Viktor Schauburger page](#)

amazon.com
and you're done.™

**Shop
Now &
Save**

[Click here](#)

[Privacy Information](#)

- [Electronics](#)
- [Books](#)
- [Music](#)
- [DVD](#)
- [Video](#)
- [Toys & Games](#)
- [Today's Deals](#)
- [Kitchen & Housewares](#)
- [Tools & Hardware](#)
- [Computer & Video Games](#)
- [Outdoor Living](#)
- [Apparel & Accessories](#)
- [Camera & Photo](#)
- [More...](#)

- END -

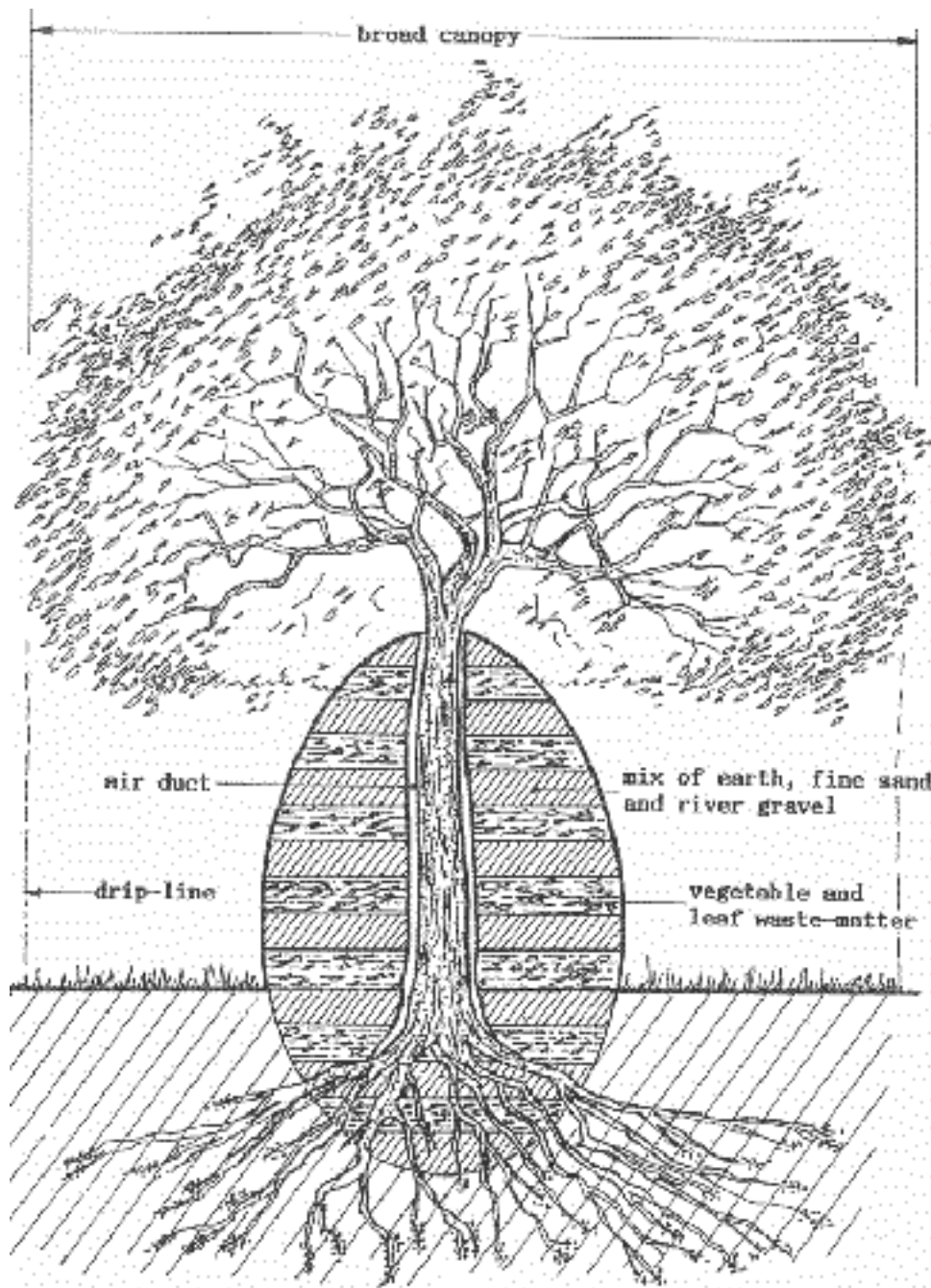



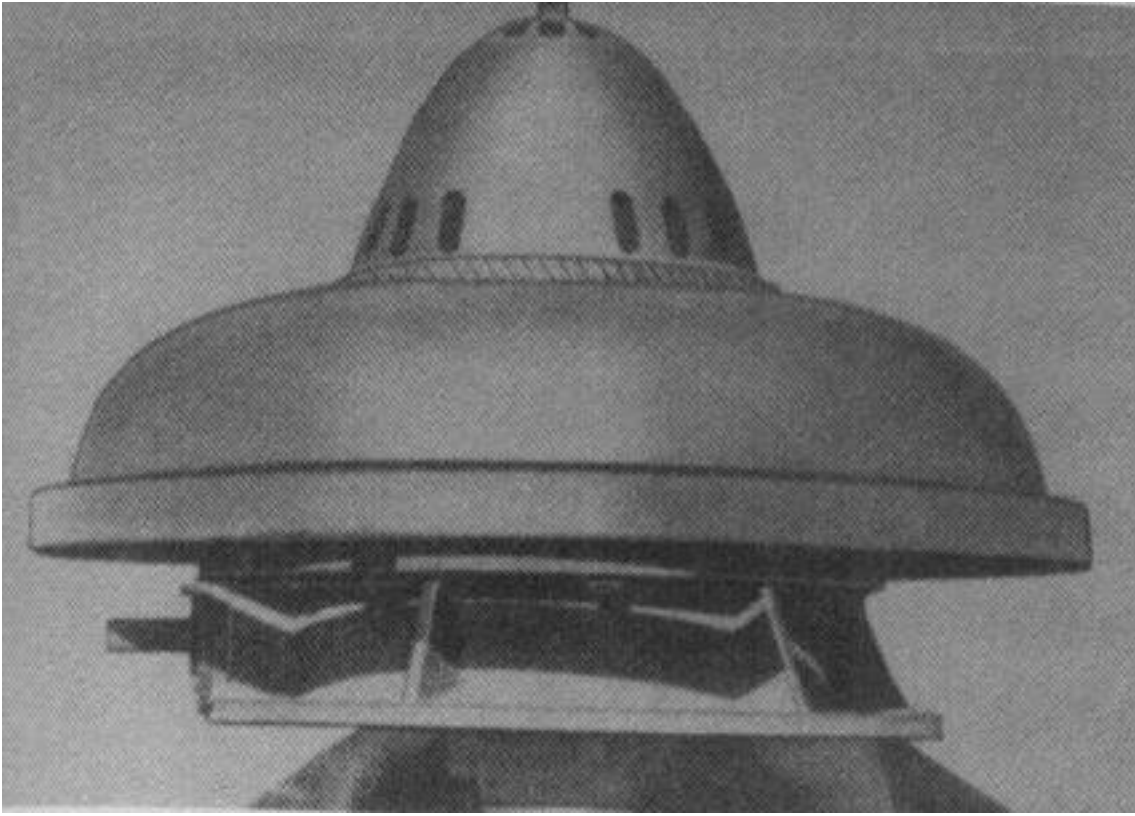

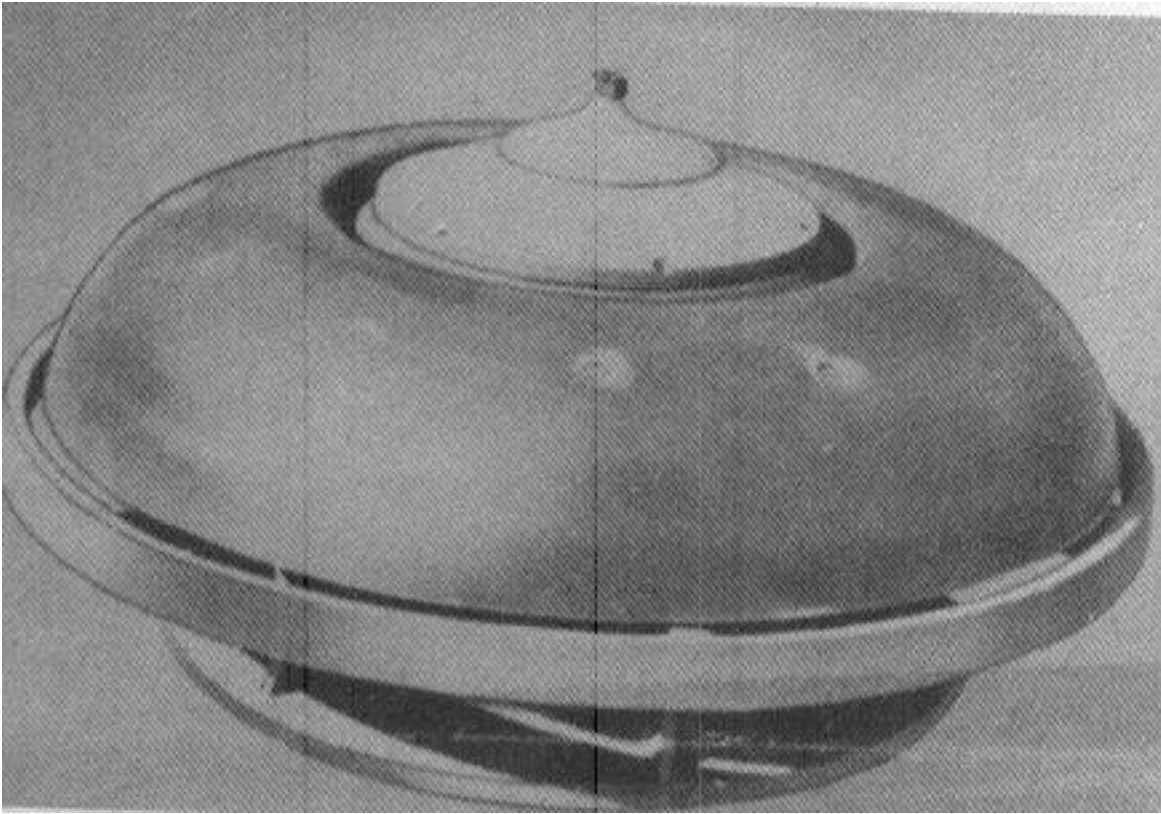



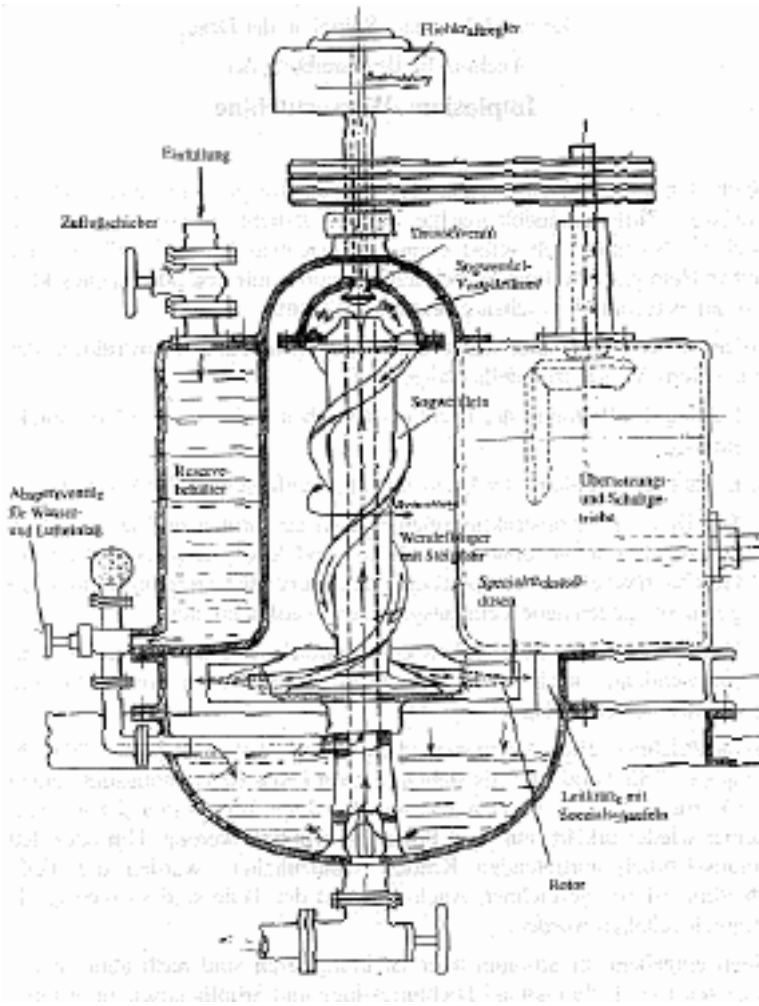



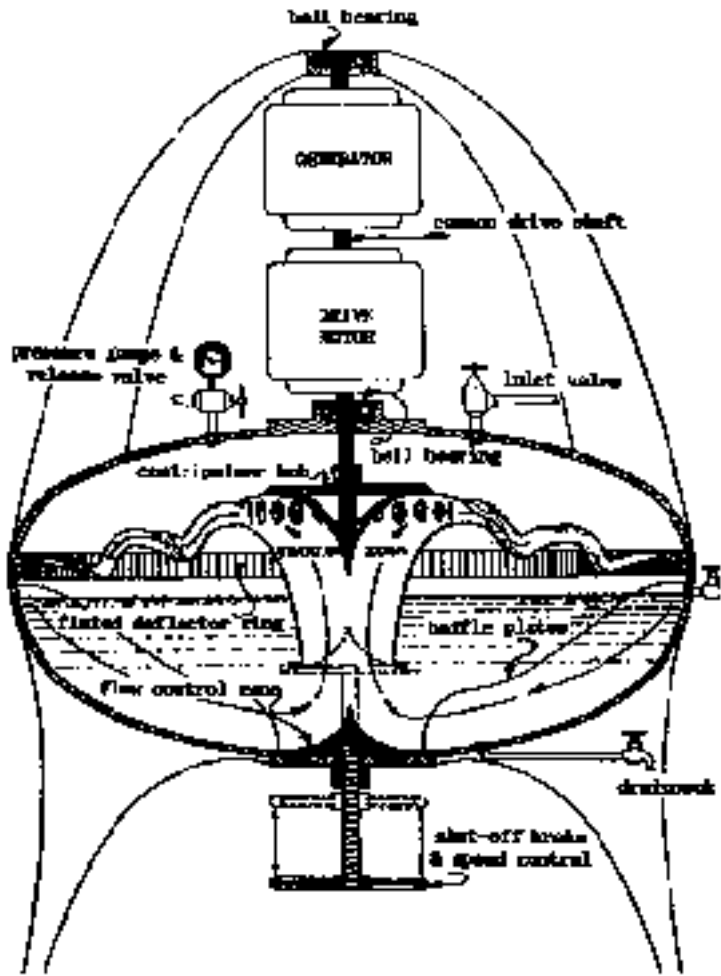

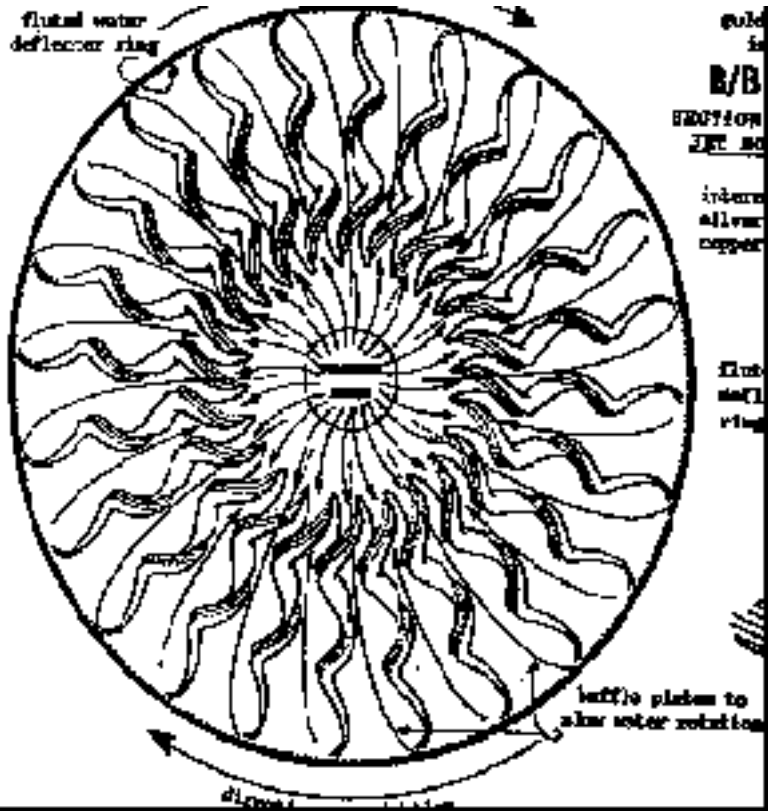

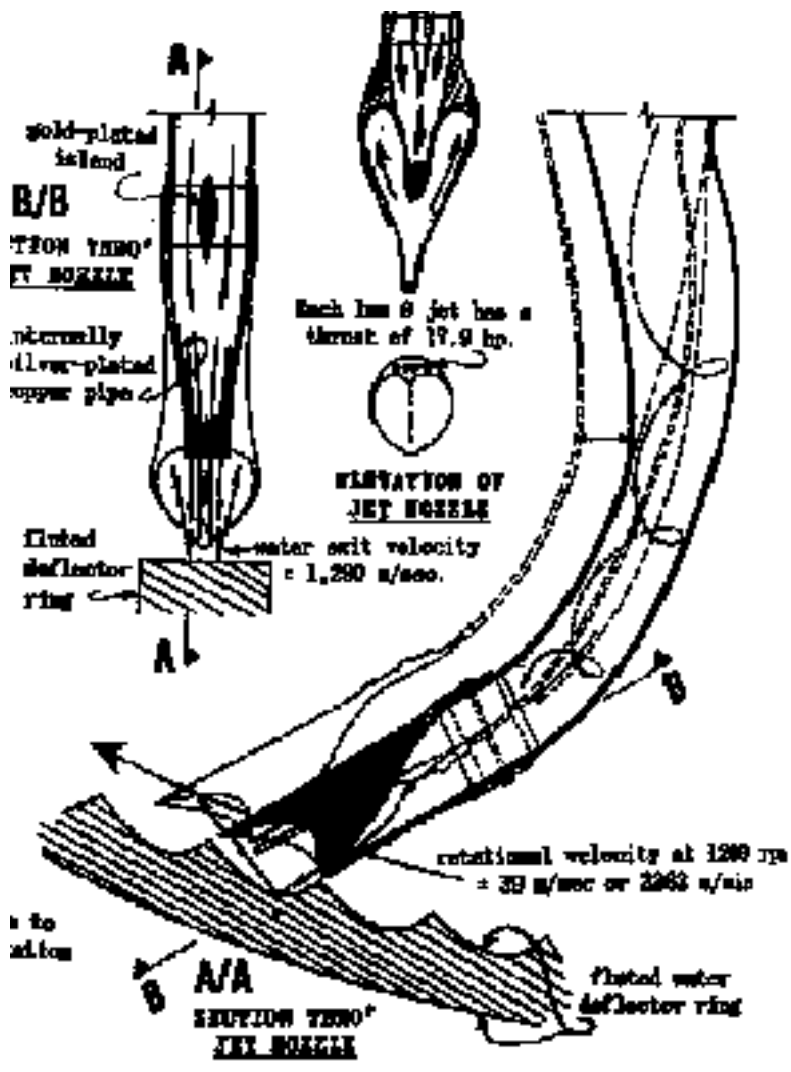

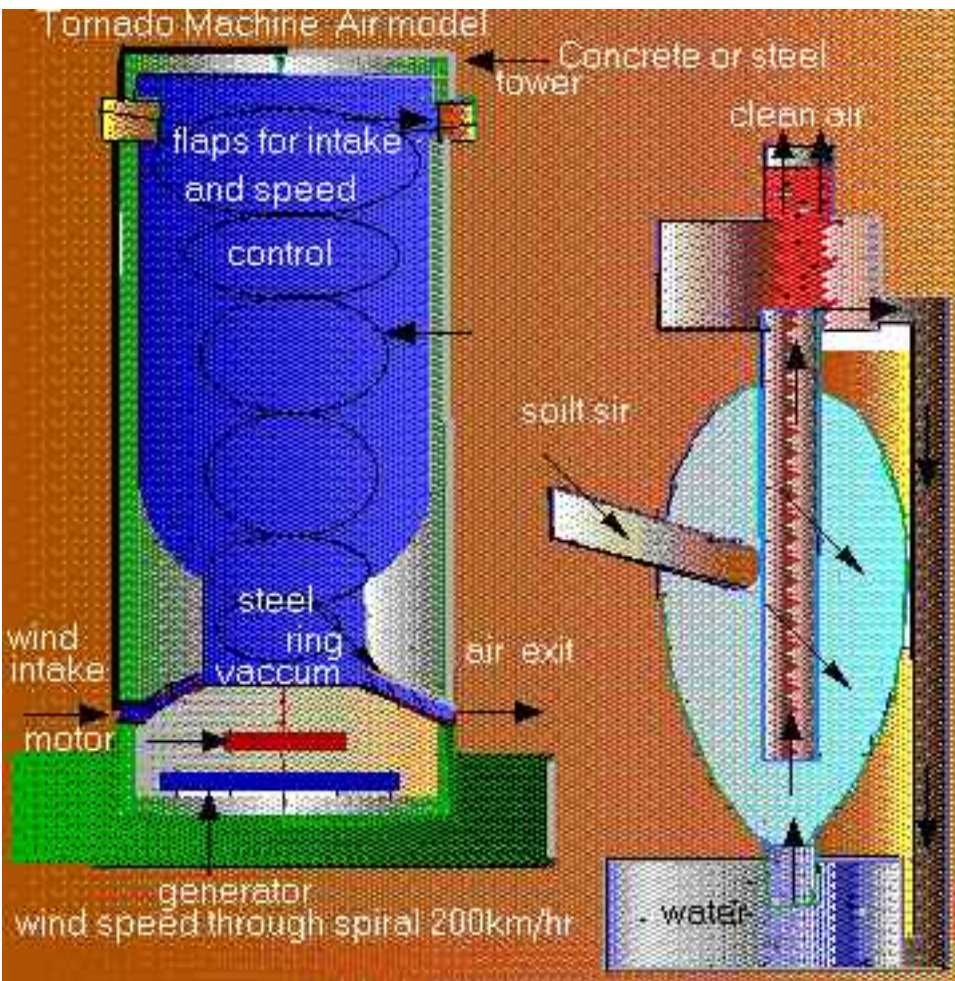

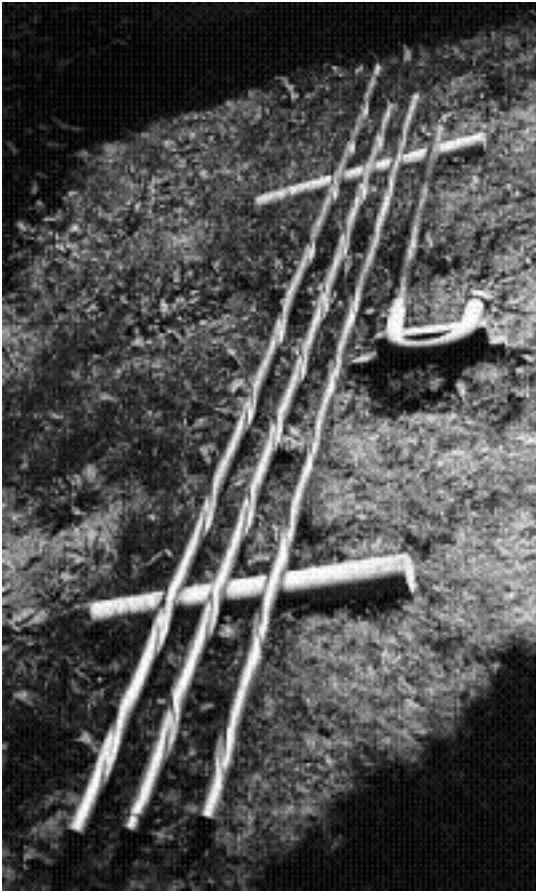

Whirlpool Power

Chapter One

The Origin of Energy

The screenshot shows an Amazon.com storefront with a yellow header. On the left, a 'shop now AND SAVE' banner says 'Save big on thousands of products!'. A navigation menu lists 'Computers', 'Books', 'Music', and 'DVDs'. On the right, the Amazon logo says 'amazon.com and you're done.' with a 'Click Here' button.

The main content area has a light purple background and displays several book listings:

- Living Water** by Olof Alexandersson... New \$11.95!
- Nature As Teacher** by Viktor Schauberger... New \$12.21!
- Det levande vattnet** by Olof Alexandersson...
- The Schauburger Companion** by Callum Coats New \$21.95!
- Energy Evolution** by Viktor Schauberger... New \$13.57!
- Living Energies** by Callum Coats New \$17.79!
- Living Energies** by Callum Coats New \$19.95!
- Living water** by Olof Alexandersson...
- The Fertile Earth** by Viktor Schauberger... New \$13.57!

At the bottom, there is a note '(Prices May Change)' and a link for 'Privacy Information'.

Man once thought the Earth was flat and at the center of the solar system. This was a natural conclusion to come to for that is the way it appears. It still does. But we learned something in the recent expression of man's knowledge, recent meaning hundreds even thousands of years, a blink of the eye in known time of man's existence; that everything is not always the way it seems. In fact it is almost always not the way it seems.

This fact should be applied to all scientific observations because the pattern of this fact, know as "maya", is very well established. We see it in all forms of analysis of human existence and behavior. It is as if the truth is buried beneath the surface and beauty is truly only skin deep.

We have a science today of exact measurement, analysis, and everything one would think it would take to get to the bottom of things, but, we still seem to only look at the surface, take our measurements, and declare this is the way it is; not realizing we have not learned from history and repeat the same mistakes over and over again. Much like

our ancestors said the Earth is flat, it looks flat thus it is flat. Galileo found how strong a false belief is when he said the Earth was not the center of the solar system, and gave a very convincing argument only to be excommunicated and held under house arrest so he could not continue to defy the authority of his time.

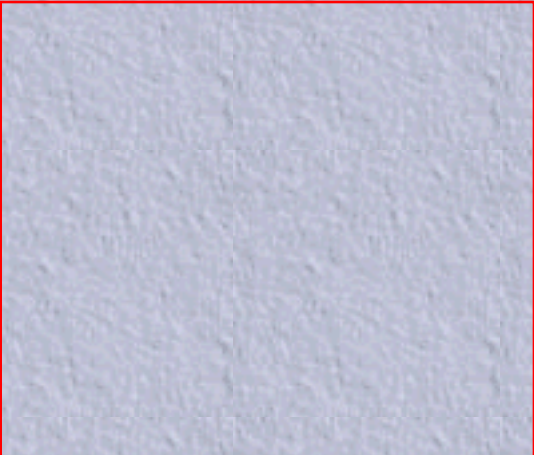

And, so it is today. But, “the times they are a changin’” as the song goes. Information is taking a quantum leap and Galileo has his day in the Sun again to challenge the false notions of surface measurements and look deeper into the mysteries of space and mind.

We have seen energy for quite some time as something related to and originating from light and heat. Our science is based on such a concept and has an enormous amount of data to back it up. Thermodynamic equations, action reaction principles all show how heat and energy are related. But something new has arisen that shines a new light on the subject, that of something called Zero Point Energy (ZPE). That energy can and does exist in the absence of light and heat.

According to science as written this should not be possible but it doesn't take an Einstein to figure it out. It is quite apparent. I will try to explain how this perspective shows energy's origin is not heat and light but gravity. Gravity is the force, the energy behind all motion, not heat and light. Speaking of Einstein, he had an idea along these lines but failing to find the proof, or the common denominator to his Unified Field Theory, the idea has almost been totally dismissed by science as a pipe dream Einstein dreamed up while puffing his pipe and pondering the grandeur of the universe.

The Pearl of Wisdom starts with a more complete understanding of the most basic action in our lives, the rain. Water is alive. We are mostly water. The action of evaporation and rain is the engine of life. Science has long stated evaporation is due the Sun; that the heat of the Sun causes evaporation. I propose a different reason. Gravity is the reason, the driving force behind evaporation and this is why.

The Sun's heat vaporizes the H₂O molecule bringing it to a higher state of vibration. This vibration expands the molecule and breaks it free from its viscous hold turning it into vapor. But there is no force of the Sun causing the vaporized molecule to rise. It is much like a scuba diver's bubble. There is no force pulling the bubble to the surface, gravity pulls the more dense water beneath the bubble and pushes it to the surface. The same with evaporation. There is no force from the Sun pulling the water molecule up.

Gravity pulls the more dense atmosphere beneath the vaporized H₂O molecule and pushes it to the clouds. That happens as we know in a high pressure system, and conversely in a low pressure system gravity pulls the more dense H₂O beneath the less

dense atmosphere to make the rain. This gravity pump is the energy that drives the process, not the light from the Sun.

That is the first step in understanding The Pearl of Wisdom and that Pearl is as abundant as the rain. We think of heat and light as energy but that is just a surface observation. The Sun actually does the same thing to the photon as the Earth does to the water molecule. The gravity of the Sun pulls the more dense space beneath the less dense photon and pushes it outward. The photon is really the ultimate void. Space on the other hand is much more dense. Science has debated this point back and forth for a long time, but never have they seen the simplicity of the Pearl of Wisdom. The photon is just riding on that "old gravity train" a train that really just jiggles, vibrates, and passes the photon along while the space itself does not move but just the amount needed to move each photon. In saying photon it would be best to say it is like the space between the waves at the ocean. This space moves between the crests of the waves while the ocean basically stays in the same position. And the same with the atmosphere. It does not ride with the H₂O molecule it just passes the molecule up like a bucket brigade, that "old gravity train", with gravity as the engine.

One might argue that without the heat and light none of this would take place. This is true to an extent, and an analogy can be made that the Earth needs to be large enough to look flat to be round, but in that argument the point is missed. The Origin of Energy is gravity not heat. Heat exists due to gravity, gravity can exist without heat. It is the gravity that is the origin not the heat and light. It takes the gravity to apply the pressure needed to ignite a star in the first place. And gravity and energy can exist in the absence of heat and light but the converse is not true; heat and light cannot exist without gravity. It would be very possible for a system of un-ignited stars or planets to circle around a black hole far away from our known universe and have an enormous amount of energy without any heat or light if they were too small to have enough pressure to ignite. Recent research has shown the frame dragging effect of rotating objects does exist. This was just a theory for many years and thought to be invalid. And the measurements are much higher than expected.

I think the frame dragging effect is doing far more than science currently understands, and will go into more detail in the next chapter on Whirlpower Theory.

We can actually see the wiggle, the wobble, the jiggle, of gravity pulling on the fabric of space in the twinkle of a star. The twinkle is the vibration of gravity pulling the space beneath the photon when it slams back together. One could make the analogy to thunder; gravity pulls the atmosphere back after a lightning strike. And speaking of lightning it too has its origin of energy from gravity, that is why it is said to travel from the ground up instead of coming down from the sky. The void is opened and gravity pushes the less dense negative charge up that connects to the positive charge and the electrons balance with the flash. This creates a click sound. Then gravity closes the void

pulling the more dense exchange of positive charges down. As it closes, the door slams, and - boom - the classic thunder clap is heard. Tests in Zero Point Energy research show florescent type light can be turned on and off with a measured amount of energy. Then the sound energy is measured and is larger than the energy put in to turn it on. If the thunder of lightning were measured in energy and compared to the energy of heat and light in the lightning I think it would show the same higher measurement. I have not heard of the experiment being tried or theorized.

All this is not to say light and heat don't have energy. They contain energy just like science understands as far as I can tell. It is the origin of this energy this theory tries to express.

One might say, you can shine a flashlight against this outward push of gravity that proves gravity is not the origin. I think an experiment of this sort would show the intensity of a flashlight shining up measured over distance would be brighter than the same flashlight shining down, and is the reason a candle flame goes up. The energy contained in light can beam itself against this outward push of gravity, when coherent (as in the laser) it can blast through solids, but in its ultimate origin gravity is the reason, and the energy behind its travel through space.

Like in a centrifuge, but reverse in motion, it is going to be hard to stop the less dense material from moving to the center because the more dense is moving outward.

There have been great strides in the understanding of The Origin of Energy by science I have just found out about in recent weeks. Although I have been speaking about this for quite sometime my theory has been scorned and I have suffered ridicule because I do not have proof of these ideas. I am very glad to finally be seeing science is also coming to an understanding of gravity and I hope the work of some of these scientists will allow a further and more in-depth review of this work. I have most recently discussed this with some of the prominent scientists in this field, and learned of their work. Although it appears to be in it's infancy and does not have the full understanding of the Pearl of Wisdom, it is much further along than my college days 20 years ago.

Recently I had the opportunity to discuss my ideas with scientists on Bill Beaty's vortex list that has a number of new energy scientists working on Zero Point Energy. Including Hal Puthoff, whose work has proven Zero Point Energy is viable and not in violation of the laws of physics. During this introduction initially I was treated with skepticism but eventually made a few points with the group and learned for sure my approach is unique and un-theorized in it's completeness before. My version of evaporation is unique, my version of the motion of light and heat is unique. I have yet to receive acknowledgment from these scientists as they have not yet reached the full understanding of the Pearl of Wisdom, but they are much closer and are at the brink of understanding. This work can be seen in the archive of; <http://www.eskimo.com/billb/weird/wvort.html> , and also in an

active archive at the Science and Spirituality list at Spiritweb, I have a running chronicle of this work going back for over a year. Here I introduced my Whirlpower Theory (which is in the next chapter) and built the comprehensive and cohesive theory of gravitational energy and a unified field theory leading to the Pearl Of Wisdom and The Origin of Energy. My theory starts out simple inspired from a dream I had about a giant whirlpool being used to generate electricity. This work can be seen at; <http://www.spiritweb.org/cgi/ml.cgi?list=science-l&passwd=devotion>

Chapter Two

Whirlpower Theory

The whirlpool, something most never think about, fascinated Aristotle. He even threw himself in one because he could not figure it out. And it is something used all the time as a symbol to catch people's attention. The spiral symbol carries a powerful symbolic message of appeal known well to advertisers and the media. During the past year I have noted a constant stream of whirlpool and vortex imagery used in many arenas. But where is the whirlpool?

This became one of my first questions as I began my research a few years ago on the information about whirlpools. I found out very quickly there was none. No scientific data of any kind on a whirlpool available. But I found an enormous amount on the vortex.

People had built them and tried to tap them for energy. Interesting; I was looking for information about building a whirlpool and tapping it for energy, but no whirlpool found. There was only a scant obscure reference about the eddy vortex and the bathtub drain vortex. Nothing was said about putting the two together. Nothing written on what I called the Compound Vortex.

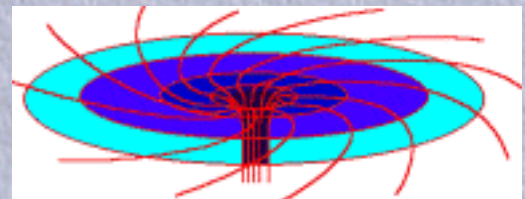

Whirlpower Theory is a very simple theory. The very basics of it say a whirlpool can be built in such a way as to generate electricity, and that the energy comes from gravity. Gravity is not recognized as energy in the classic sense to standard science. But, the new forefront of scientific ZPE shows that there is proof that gravity is energy, just like Einstein predicted.

If a whirlpool is built with a compound vortex, meaning a broad wide eddy type vortex coming from outside push, and the small simple bathtub drain type vortex from inward

pull, the giant whirlpool is constructed. It most likely has never existed naturally in nature. The closest thing nature provides as a model is the hurricane. And the difference in the tornado and the hurricane is the closest thing I have found in the difference of past vortex research and Whirlpower Theory. Scientists have built tornado wind tunnel type vortexes and measured them but I have found no evidence of building a hurricane type vortex and measuring it.

The biggest mistake I see in vortex science is thinking the vortex can be tapped. Even taking a measurement of its power reduces the power more than the measurement taken. This is part of the heart of relativity science as to observation and measurement actually changing what is being observed and measured. That is what makes everything relative. It is much like snuffing out a flame trying to measure the heat. In Whirlpower Theory it is stated the vortex must not be disturbed. The part of the whirlpool tapped for energy comes from the action of gravity on the vortex, not the vortex itself. Gravity causes the vortex to wiggle, wobble, jiggle; now we have heard these words before, in the Origin of Energy, in ZPE.

It is the same thing. The wobble of the vortex causes a dragging effect on the water surrounding the vortex. This current of water, donut in shape, goes round and round but does not go through the vortex. They are two different systems. This effect in space is called frame dragging and was just recently proven, although theorized long ago. Several studies and a couple of frame dragging theories currently under study by science still leaves much of this action unexplained. The reason is science does not have the basic understanding of gravitational energy and does not recognize the wobble as the driving force in frame dragging. They think it is the rotation. They do not understand that the black hole wobbles. This misconception permeates all of science.

It is also evident in the explanation of the motion of the Moon around the Earth. Conventional science explains the motion of the Moon as coming from the Moon. It is said the Moon causes the tides and the tides then cause the motion of the Moon. I think the wobble of the Earth causes the tides and this wobble frame drags the Moon. Just to think the gravity of the Moon is strong enough to override the gravity of the Earth and move the oceans and then have enough energy left over to make the Moon go around the Earth and add to its radial orbit breaks every law of physics in the book. Not to mention that the wobble of the Earth is not even considered in the equation when the wobble moves trillions upon trillions more mass than the tides do. The wobble moves the entire Earth. So really what we have here is a traditional science theory based on a perpetual motion concept relating to the motion of the Moon. With this false theory as part of basic traditional science it distorts all of science. This is much like thinking the Sun went around the Earth. When such a basic concept is wrong but accepted by traditional science it throws all of science off. And that is why science cannot explain things like tornadoes and hurricanes. But it goes even deeper than that. The Sun

wobbles and its frame drags the planets. And to top it off, the more dense core of the galaxy, complete with black holes, wobbles and frame drags the bulk of the galaxy including the Sun and solar system.

A recent study by astronomer Vera Rubin shows there is an unaccounted for 90% motion of energy in spiral galaxies she has observed and measured for 30 years. This study shows traditional science has not been seeing 90% of the picture relating to energy and is said to be a study that will change the scope of science forever. She does not say she knows what is actually happening. Theories have been thrown up referring to anti-matter and mysterious dark matter. I think it is Whirlpower. The spiral galaxies, including our own Milky Way galaxy work just like a whirlpool. And so does the hurricane. And this is also why science does not understand the awesome power of the hurricane. They do not understand the "gravity of the situation".

It is very important we get to the bottom of all of this because we need a clean energy source for our planet if we are to survive. Time is of the essence. Many times, I am asked "where is the proof?" I am told, "don't talk about - it just build it," and that is exactly what I would like to do; build it. And if it works, that will be the proof. It will explain so many things that appear to me a pattern of unexplained things. It is that pattern of unexplained things that makes me think this will work. My theory is not from scientific answers but the lack of scientific answers to many different questions relating to the spiral motion of things. From the toy top, the whirlpool, the tornado, the hurricane, the solar system, to the galaxy, there is a common thread of mystery; and with that common thread of mystery this theory is built, and with inspiration from my dreams.

The most exciting part to me is that it is provable by building a Whirlpower machine. This involves building the biggest whirlpool possible, as wide as possible with a strong vortex getting as much wobble going as possible. What these parameters are, and does it need to be large to work, are questions only scientific analysis and experimentation can bring answers to. I don't think a miniature model would be the best approach since we are working with gravity. It might be like making a miniature solar dish, a miniature windmill, etc. It needs to be of a scale proportional to its need to some extent. It would be a shame to build a tiny one that did not work because it was not large enough to use the mass effectively. Almost like building a miniature automobile complete with a tiny gas motor would be harder than building a larger one.

By pumping water out of the center and back in at the perimeter creating the compound vortex, Whirlpower is set in motion, much like starting a gasoline motor it must be in

motion before it will run. When the vortex/feedback loop system is running and the wobble of the vortex sets the donut system into action due to the force of gravity, energy from gravity can be extracted to maintain the vortex/feedback loop system. I think the donut system will contain 90% of the mass of the system. The vortex/feedback loop will contain 10% of the mass. The speed throughout the system will vary but not a lot with the highest speed most likely near the center of the vortex/feedback loop system, midway between the center of the whirlpool and the outer perimeter, much like the hurricane. The hurricane is the model I am trying to replicate in the whirlpool, and if I can, it should have the same unexplainable energy found in nature. But it will no longer be unexplained - it will be Whirlpower.

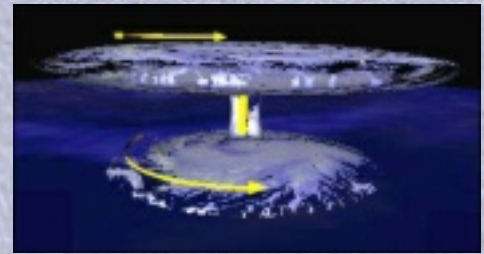

I hope this theory will reach those that can help me find answers to these questions and help me build a whirlpool and test it. Just the fact one has never been built and tested appears to me as an enormous exploration gap into something that should have already been tested, if not for energy extraction, but for a more basic understanding of hurricane and vortex science; that seems to be completely in the dark as to the explanation of these most powerful forces of nature.

I say, for flight, look to the bird; For power, look to the hurricane.

If Whirlpower is proven there are many other forms it can take. Many I have explained in the on-line work I have done and I am sure there are untold spin-offs yet to come. If Whirlpower is proven, the knowledge of it alone will lead to an energy revolution since the technology is so simple. It will not take expensive high tech gadgets to apply the concept to practical application. It can provide an economic boost to any poor and working man who wants to apply it. Having a clean power source will be as simple as putting in a fountain with basic plumber and electrician skills. Kits could be assembled that almost any handyman could build. All it takes to find out is to build the whirlpool. It will take thousands to find out, but not millions.

Chapter Three

The Holy Grail

amazon.com
and you're done.™

Shop
Now &
Save

Click here

Privacy Information

- [Electronics](#)
- [Books](#)
- [Music](#)
- [DVD](#)
- [Video](#)
- [Toys & Games](#)
- [Today's Deals](#)
- [Kitchen & Housewares](#)
- [Tools & Hardware](#)
- [Computer & Video Games](#)
- [Outdoor Living](#)
- [Apparel & Accessories](#)
- [Camera & Photo](#)
- [More...](#)

ZPE (Zero Point Energy) is said by the DOE (Department of Energy) to be the Holy Grail of energy research. I think Whirlpower is the Holy Grail. In mythology the Holy Grail is something that man searches for in a number of epic adventures. It is said to be almost impossible to find. Like looking for a needle in a haystack full of needles. One analogy I have made in my work is it is like looking for the missing puzzle piece in a giant jigsaw puzzle with nothing but blue sky. You have to look for the negative shape of the missing piece, not the piece itself.

There is also the spiritual aspect, Holy Grail meaning something that relates to God. So really what we get is a scientific and spiritual understanding in learning what the Holy Grail is to start with and what it does as it relates to the connection between God and Man. It is obvious something is wrong on Earth with this most important scientific and spiritual understanding of the truth.

In spiritual terms there is something known as the Tao. The Tao means the way things work, or more simply, "the Way". A concept of wisdom called Taoism is known throughout the world but is not seen as a religion in the classical sense. We also know in the Judeo-Christian world of the story of eating the fruit of the Tree of Knowledge of Good and Evil. Both of these concepts of the forces of positive and negative, and the knowledge thereof lead to the understanding of these most elemental forces, and that understanding leads to wisdom; and I think the Pearl of Wisdom, of which, now, you are reading.

Plus, all of this has come to me in such a way as to intuit this theory more than by coming to it in terms of scientific analysis and experimentation. Dreams have played a major role in its development and plain old common sense. That, plus looking for what is not known just as much as what is known has helped me put the puzzle pieces together.

The symbol of the Tao can be plainly seen in the hurricane and was one of my earliest and most important clues. But I was well into my theory before it became evident the Tao, the Knowledge of Good and Evil, and the hurricane, are related in this most amazing puzzle. In my dreams I was able to tame the “beast”, the tempest, and caught the tornado, miniaturized it, and held it in my hand. And may I say, once you have held a tornado it gives one a better understanding of the vortex. Plus, I saw a giant whirlpool in my dream and was overwhelmed with its awesome power and glory. Then by process of discovery and study I learned about what has been tried and what hasn't been tried in science along these lines. The missing piece turned out to be the whirlpool. Plus science has never been able to explain the hurricane and it was just announced in prime-time on TV that almost everything science once thought to be true about the vortex has just this past year been proven to be wrong. And that science needs to go back to the drawing board and start all over.

The Holy Grail has been presented to the world as Whirlpower Theory and is a gift. This means everyone should be able to use it for their own betterment, not controlled as a monopoly by any person (including myself), company or country. I think this is most important. It can give many people, not just the rich a way to help the economy, and of course will be a nonpolluting source of energy.

There is more to the Holy Grail than just Whirlpower. Many of my inventions have an element of this type of thought. It is my hope to one day be able to bring more of my work in the world. As it stands now I am just one man, not a company or organization, nor am I backed by any money, nor do I have to answer to any board of advisors. I hope, once funded for research, I will be able to continue this research and build a Whirlpower machine. I have just secured www.whirlpower.cc for this purpose and will place all my information, news updates, building procedures and results for full scrutiny by interested parties. When completed, individuals, companies, countries, would all have the right to implement my theory into their systems free of charge under public domain. I will however express to any of those who want to remember and want to give what they wish, such money will go to into my organization dedicated to the discoveries of the mysteries of space and mind.

We are told by many we are entering the “New Age of Aquarius”. Aquarius is denoted in Astrology (the old world mix of astronomy and religion) as the water bearer, of a being holding a water vessel and pouring out water as a stream of stars. If the twinkle of a star is caused by the quantum jiggle of ZPE, and it is that same gravitational energy behind

the driving force of Whirlpower in the wiggle, the wobble of the vortex; then the analogy is astounding in the scientific/spiritual cosmology of the Holy Grail.

In addition, Ezekiel's Wheel has a number of interrelated spiritual symbolic references I have noted in my dream-work. As a lucid dreamer, much of my work is done on this concept in my REM state of sleep. I am what is known as a conscious dreamer. I maintain consciousness in REM state and thus have more memory and control of the dreaming process. Stanford University is noted as a leading researcher of this type of now recognized valid occurrence. They have been in contact with me and have asked me to participate in their research. After I finish my work with Whirlpower I may decide to work with Stanford in these matters. I feel the subject has definite scientific validity and with the proof of Whirlpower Theory I hope my story will give greater credibility, understanding, and wisdom to their research.

I hope those reading this will give this the utmost of consideration and give this work a thorough and fair analysis. I have stated all I know in the clearest and most concise, truthful manner I know how to regarding this most wondrous of possibilities. I give the highest credit to God and my dreams, for the inspiration, and the strength, to get to this point; to have dreamed the impossible dream.

Chapter Four

Whirlpower: The Machine

In this chapter I will try to explain Whirlpower, The Machine. The Whirlpower concept can be applied many ways, but in this chapter I will try and focus on a basic way to use the whirlpool.

WHIRLPOWER THE MACHINE



In the first Whirlpower picture you see a tank of water. This tank can be of any size but the larger the better and it may be that it has to be of a certain size or larger to work. I suggest we start in thinking of it as 30' across and 10' deep. It is very important to be as wide as possible to get the full eddy effect. My research has shown this approach is different than that other vortex or wind "tunnel" types of vortex energy theories. In Whirlpower we are trying to tap the gravitational effect on

the vortex, not the vortex itself.

In the water is a wheel with fins. This is referred to as "the big wheel". It sits in the torus donut and turns with the current and does not touch the vortex. It connects to a number of wheels on the perimeter that turn the pumps and generators. There should be at least two and in most cases more, especially the bigger it is built. This connection can be simple. The big wheel just rides on the little wheels that are in a fixed position in the water and turns an axle to another wheel outside the tank. It is possible for the pumps and generators to be in the water but I think it would be easier to maintain outside.

The entire system is started by turning the wheels on the outside and setting the pumps and big wheel in motion. Once the vortex forms and the torus donut is at the right speed power input can change to power output. It will then sustain itself and generate electricity by the force of gravity acting on the vortex causing it to precess.

We usually don't think of a vortex precessing since it is fluid not solid. This is why Whirlpower has remained hidden all these years. But as we know the faster water goes the more it acts like a solid, much like hitting water at a high speed is similar to hitting the ground, be it falling airplane or skydiver or distraught bridge jumper.

So it is this precession force due to gravity that is the driving force in Whirlpower. But the whirlpool must be built in order to bring this force to life, so to speak.

The next picture shows a little more detail and overview and compares the compound vortex to the torus donut. This is what it all comes down to. Is the mass and speed of the

torus donut more than the mass and speed of the compound vortex?

And is this difference enough to sustain the system and generate electricity and do work? All my research shows it will and is the same force that drives the hurricane and the planets and the stars. Beautiful simplicity in motion.

This next picture is of the Holy Grail. This is the Golden Chalice. It is still Whirlpower but the donut is compressed by the shape of the bowl allowing for the width needed for the eddy and fits the hardware. I think this may also be what was once known as Hero's Fountain and has been done before but the knowledge was lost over the centuries.

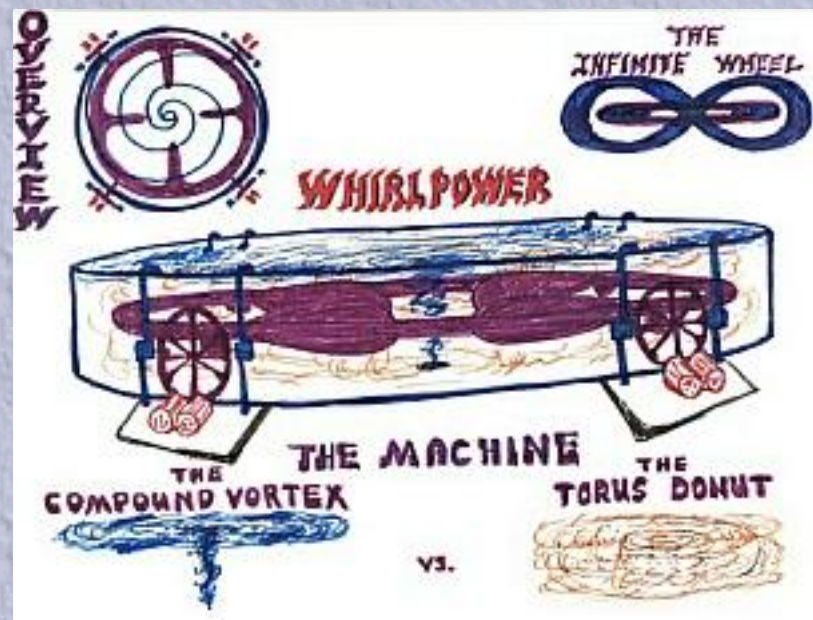

It has the Osmosis Water Cleaner shown. This system made of gold would not corrode over time and would be perfect for small home systems that would provide clean water by the centrifugal force. The heavier particulates would go to the outside and drain off slowly through the output. It could be hooked up to any water system. Stainless steel would probably be the best choice in a practical sense but gold or gold plate may still prove to be the best.

In the next chapter I will show variations on the theme and a number of other ways the Whirlpower concept can be used.

More acknowledgements: I want to thank Dan Winter, <http://www.danwinter.com> (this link may be obsolete) for being one of the first to recognize the possibility of Whirlpower and making the connection to his work on Sacred Geometry. His definitive text is a masterpiece and I think it relates to the kind of actions Whirlpower and related works I have in progress are based on. I think Dan and I will eventually work out the mathematical formula of these actions using his phi based Geometry.

I want to thank Curt Hallberg of the Malmo Group in Sweden. His keen perception of the similarity of my work and the work of Viktor Schauberger's long ago has been very helpful. Curt hopes to test the Whirlpower concept soon. Curt has a test of principle

example of Whirlpower in his earlier work of a water cleaning devise that has similar Whirlpower properties. Test of principle model: <http://home5.swipnet.se/~w-58759/energy/whirpow/Whirlpower.html>

The Beginning

by David Dennard

What is Whirlpower?

Whirlpower is a gravitational force of spinning mass. While spinning a charge makes an additional magnetic force, spinning mass makes an additional gravitational force. The greater the wobble the more it will affect its surrounding area. All spinning objects wobble be it ever so great or small. It acts like a lever as far as how gravity affects the area around a spinning mass.

When the hurricane gets big and fast enough, the eye wall wobbles and pulls the hurricane. This acceleration is Whirlpower.

The debris field kicked up by the tornado that picks up huge objects like cars, houses, the infamous flying cows, etc., is the effect of the spinning vortex on its surrounding area. This effect is Whirlpower.

When a neutron star spins at 300 revolutions per second it causes matter to spin around it in orbit at 1,000 revolutions per second. That acceleration is Whirlpower. A black hole frame drags gas around it, and it is "wobbling like a child's toy top as it slows its spin and begins to teeter in all directions" (quote from Kathy Sawyer, the Washington Post). The Earth spins and wobbles. This action pulls on the Moon increasing its orbital radius. This increase is Whirlpower.

The sun spins and the wobble drives the planets - Whirlpower. The Galaxy spins like a giant hurricane, the dense core wobbles and the stars proceed. Need I say more?

Of course; and I have to keep saying it till we build the whirlpool. The hurricane is said to be the most mysterious event in nature. It was announced on the news recently that "almost everything science had thought to be true about the vortex before, was wrong"!

Now you don't have to be an Einstein to see a pattern starting to develop. If you read my theory in detail and look at my "childish sketches", I describe a machine that can use Whirlpower to generate electricity and clean water.

We need Whirlpower NOW!

Whirlpower is about gravity being "The Force" and how that force works. It is the Phoenix, Tao of Eagle, the "Way" things work, the principle of flight, the power of the hurricane, the driving force of the Universe. It is opening the void. Density displacement; Motion due to gravity.

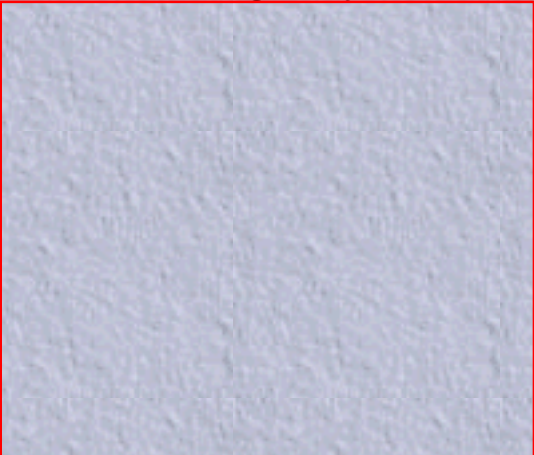

Gravity is like the balance of the scale, it will always try to balance. It causes the motion by pulling on the more dense thus pushing away the less dense. It attempts to find density displacement balance. The heat carried in the void is real, but it is not the origin. Understanding this leads to understanding how gravity really works and how a machine can be made to harness this force.

Whirlpower is one of many design concepts that can harness the force of gravity. It is simple and easy to understand once you understand "Pearl of Wisdom". If you think it is creating energy then you don't understand Whirlpower. It is not free energy any more that solar, wind or hydro. Actually all energy is given freely by nature but there is no "free energy". It all comes from "The Force" of gravity. Whirlpower is "The Way" (The Tao) to follow the pattern nature provides and make a "full circle system".

The essence of the Whirlpower system is that the rotating axis of a free rotating structure will not be precisely vertical but it will deviate randomly under the influence of gravitational forces. This "wobble behavior" of the rotating structure has a dragging effect on the surrounding substance (be it a liquid or gas), which will start to rotate also. The rotation of this surrounding substance can be mechanically transformed into energy, without affecting the originating rotating structure.

When the energy contained by the mass and speed of the surrounding substance becomes much greater than the energy that is needed to keep the center rotating structure moving, one can get more energy out of the system than has to be put in. This energy is not created out of nowhere, but it originates from the gravitational forces on the center rotating structure. In the Whirlpower system, the free center rotating structure is the vortex, tornado or hurricane. This vortex is kept going by pumping a small amount from its base back up to the perimeter of its top. The drag of the wobble of the vortex causes the surrounding fluid or gas to rotate. By placing a wheel with fins in this surrounding fluid or gas, energy can be extracted from the system. The belief is that the energy needed to pump up the fluid or gas is less than the rotation energy that is being

stored in the surrounding fluid or gas.

Whirlpower

Electric power produced by a whirlpool/whirlwind

Concept

In David Dennard's own words: (May 5, 1998) - "Whirlpower is now in its 20th year. It has been in its present form since 1995, and has been through numerous changes. The current state of the art is now evolved to a point of discussion and analysis."

"There are many things in nature that point to Whirlpower. The form of the vortex is shown in a multitude of places. It seems an obvious place to explore for power. Many have, it seems, looked down this road only to leave disappointed. What appears to be obvious is well hidden and what is hidden is in plain sight."

"The main argument against Whirlpower is and has been that it is perpetual motion, that it cannot produce more power than it takes to maintain the system. This argument does not take into consideration the force of gravity nor does it consider gravity a viable force that can be tapped in the system. All arguments so far have been based on the perpetual motion premise, the action-reaction principle, and the conservation of energy equation. If gravity is not considered of a possible form of energy, Whirlpower is impossible. Those who will not consider gravity as a form of power do not argue the same points as I propose and have yet to argue the basic math of the system."

"Gravity is accepted as a viable form of power in our hydroelectric technology and our understanding of the power in falling water due to gravity. ***The concept of rotating water due to the force of gravity is the idea behind Whirlpower.*** This rotation is a secondary force of gravity resultant to the spin of an object. In massive objects in space this effect is known as frame dragging. In smaller objects within a gravitational field and in a fluid this effect is currently unknown to science."

"I am trying to introduce this effect to science and the world as Whirlpower. So far, many have said they think it is possible I am right, but most say I am wrong, and so far it is not recognized. It is difficult to find analysis, much less acceptance, since I am not in the

scientific community and have no credentials in this area. My approach to this is dream inspired.”

”When an object spins, it wiggles, be it ever so slight. When an object spins, and it is of a certain size and weight, this wiggle becomes a wobble and is known as **precession**. Large massive objects do this while spinning in space and small round top-like, funnel shaped, and gyroscope type objects do this in a gravitational field while spinning on their axis. This includes high speed fluid objects like the tornado and the hurricane. Since the speed and mass of the moisture and air create a compression hydraulic affect, these high speed spinning objects, while being fluid, begin to act like a solid object and exhibit gyroscopic like actions. These action can be seen in the wobble of vortex of tornadoes and the radial arms of the hurricane. This action is due to gravity acting on the vortex like a solid causing it to **precess**. In the hurricane this precession is most pronounced and its shape is most like a gyroscope. The tornado does not **precess** as much because it is a simple vortex and is not as “top” heavy as the hurricane.”

”This difference appears to be the difference in the Whirlpower approach to this subject as compared to others who have tried to tap the power of the vortex. This precessional force, under the right circumstances, can be considerable. Just like, at the right speed, a top or a gyroscope will **precess** in a remarkable way just before it slows down and falls over. In Whirlpower this action is held in continuation by adding energy to the spin and maintaining the rate of precession and spin, instead of letting it slow down and fall over. In a high speed spinning fluid object this is done by pumping fluid in a feedback loop from the bottom of the vortex back to the top of the whirlpool perimeter.”

”It is important to understand the fluid is not pumped directly back into the vortex, but into the whirlpool from the widest perimeter possible to get the eddy effect. This compression type vortex added to the suction type vortex made by the pull on the water through the pipe under water makes the compound vortex. This compound vortex is the secret to Whirlpower. It has much more precession than the simple vortex because it has a much larger top and acts more like a gyroscope.”

”***This precession of the vortex leads to procession.*** The precession pulls water around in the whirlpool that does not go through the feedback loop or the vortex. This current of water is donut shaped and flows around the vortex in the bell curve of the cornucopia shaped funnel. It is this current of water that is driven by the force of gravity. When the speed and mass of the whirlpool reach the proper amounts and the precession is at the right frequency, the speed and mass of the donut shaped processional current appears to be more powerful than the speed and mass of the water needed to maintain the whirlpool.”

"This is the Whirlpower Theory. It is not mathematical in basis but conceptual. I hope this concept will lead to a mathematical analysis and prototype. (...) This is scientific evolution. Seeing things as part of a whole system, seeing the similarities, not just the differences."

"Whirlpower is the concept. It is the force of the procession induced by the precession of a spinning object. In the case of the vortex and Whirlpower in a fluid, the main piece of hardware is the Big Wheel. This wheel moves with the donut shaped current of water or air, and is just a big. It is not a paddle wheel with just one part connecting to this current but it is in the current and part of the current."

"Since the power being tapped comes from the **precessional** action of the vortex, this force cannot actually be harnessed by direct contact, but by induction. This way the spin of the object is not disturbed, in this case, the vortex. The **precessional** force is tapped by induction, not by direct contact. The Big Wheel is placed into the whirlpool or whirlwind in such a way as **not to contact the vortex directly. It is hollow in the middle with fins reaching in from the rim up to but not into the vortex.**"

"This concept of power coming from the induction by the precession appears to be the difference in the Whirlpower Theory and other vortex theories. Others have recognized the possibility of power but when they went to tap it they "snuffed it out", much like snuffing out a flame. I submit this power is known and calculated but efforts to measure it have resulted in killing the exact power being measured. (...)"

"Pipes, pumps, and generators make up the rest of the Whirlpower hardware. They connect to the Big Wheel at the perimeter of the whirlpool or whirlwind. The pumps pull the water (or air) through the pipes, creating the simple suction vortex, and pump water (or air) into the perimeter of the whirlpool, creating the eddy compression vortex. Together, this is the compound vortex. All of this must be "started", much like must motors, but once in motion the Big Wheel will supply all the needed power from the force of gravity. Whirlpower harnesses the force of gravity."

(June 17, 1998): "When I first proposed Whirlpower on the internet I had no knowledge of all the previous work in the area but I soon learned of the fascination with the vortex and its history. I was constantly struck how similar but different my theory was compared

to all the rest. My theory is about a giant whirlpool, the rest seem to be about the vortex itself.”

”It seems science knows about the possibility of energy using a vortex but just has not been able to get a grip on the subject. They have tried but only succeeded in gripping the vortex and snuffing out the power. The vortex is a lot like a flame. It can’t be contained to collect its energy. It must “burn” freely and not be restrained. The vortex, “the fire of the Kundalin”, has energy but it is not in the vortex. The energy is in the wiggle, which comes from the force of gravity acting upon the vortex. **This wiggle, is the precession of the vortex. It causes the vortex to wrap time, space, and anything else, around the vortex. This is known as frame dragging.**”

”Most cases of frame dragging do not lead to a tap-able energy source because the frame dragging effect is not large enough to tap without cutting in to the spin. For example, you can’t just grab a hold of a processing gyroscope and expect to get energy. This is similar to trying to tap the precession of the simple vortex as theorized or attempted by all my predecessors. **Tapping the precession “snuffs out” the power. Only the frame dragging effect, or what I call the procession can be tapped.**”

Whirlpower:

Electric power produced by a whirlpool/whirlwind

Declaration

After timely debate, and in the presence of corroborating evidence, albeit circumstantial and synchronistic, and in the absence of disproof; I present the Whirlpower Declaration.

This is a declaration of the logical possibility and the sufficient evidence for Whirlpower to be considered as a source of power and an explanation of the acknowledged and unexplained observable reality of the mystery of the hurricane.

This information is given freely into public domain because this knowledge could never and should never be controlled as a monopoly or absolute power, but as something anyone may utilize for their own betterment and the betterment of life for all.

Furthermore, it is a reservation of the right to Free Speech and Freedom of Information.

If Whirlpower is proven and this knowledge leads to “windfall” gains to any group, organization, or individual who may wish to remember and reciprocate with a donation or love offering, all such will be put into a non-profit, public organization dedicated to the understanding of the mysteries of space and mind.

Whirlpower:

Electric power produced by a whirlpool/whirlwind

Theory

In David Dennard’s own words: “Whirlpower is the power of the gravitational force upon a spinning object. This power is the rotational procession of a spinning object. It is

seen in all spinning objects from to simple toy top, the simple vortex, the gyroscope, the whirlpool eddy, the whirlwind, the tornado, to the more complex

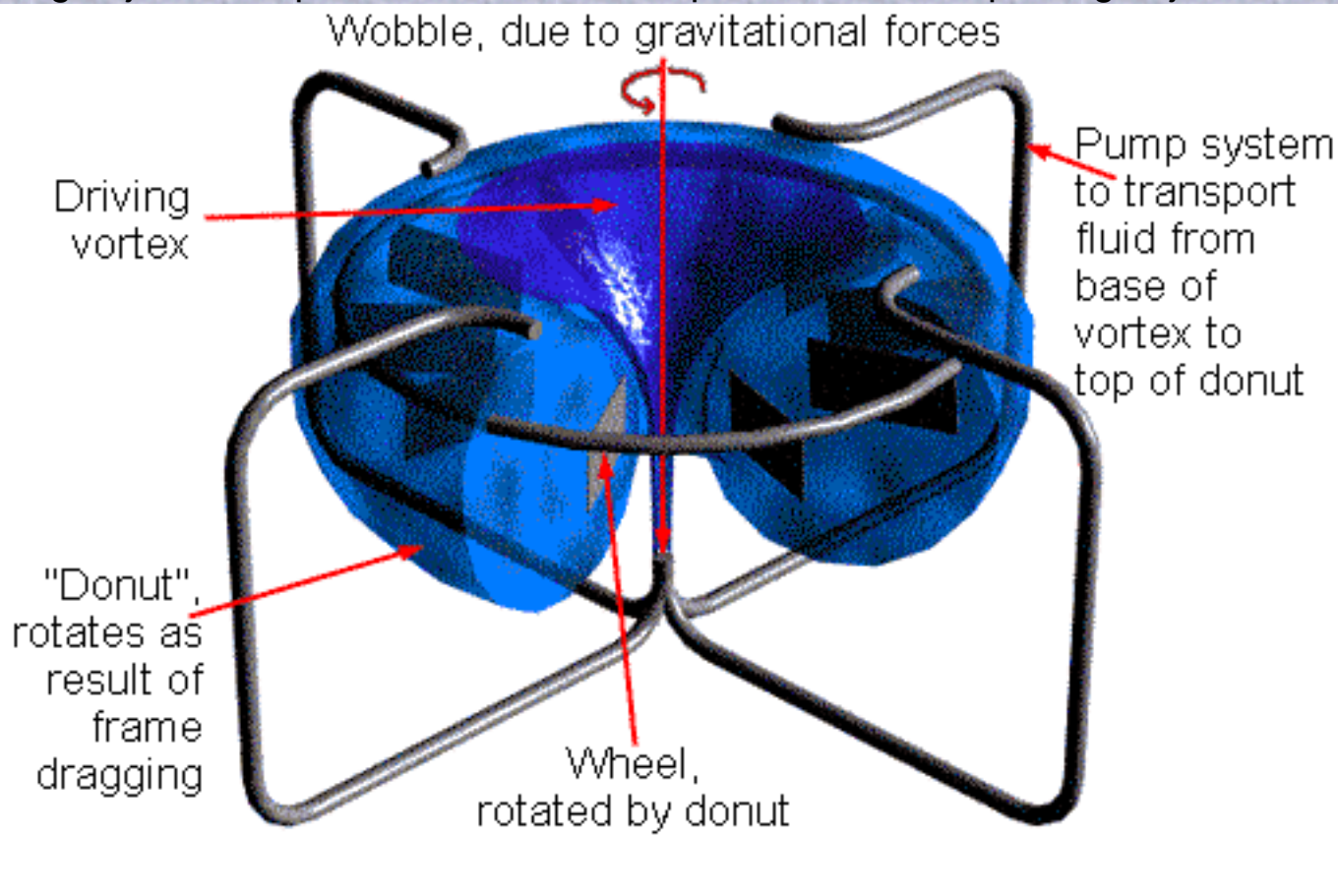

frame dragging rotation of the moon around the earth, the rotation of the planets around the sun, the motion of the universe, the black hole, and to the most complex; the compound vortex and the hurricane.”

”The application of this form of power in a devise that produces electricity can be accomplished by building an artificial hurricane. This whirlwind (or whirlpool if done with water) is made by pumping air through ducts making a feed-back loop from the vortex to the perimeter of the whirlwind in such a way as to create the compound vortex. This hurricane like whirlwind then turns a large wheel placed in the whirlwind, turning with the whirlwind, but NOT in direct contact with the vortex. It turns with the current of spinning air created by the frame dragging aspect of the large powerful spinning compound vortex.”

”The big wheel has fins that reach in but not into the vortex, and fits into the bell shaped curve of cornucopia shaped compound vortex. This wheel turns the generators and pumps once the system is set in motion. If proven, the power of the big wheel will be greater than the power needed to drive the pumps. This power comes from the force of gravity acting on the spinning vortex creating the precession of the vortex and the resultant frame dragging of the whirlwind.” David Dennard's original site is at <http://www.whirlpower.cc> .

My compliments to Mr. David Dennard for presenting this excellent theory freely to the world. I have done preliminary study on his theories and have come to the conclusion that it does, in fact, merit further research. My company, International Turbine & Power, LLC, will attempt to build and replicate these theories with and actual functioning unit. I will post the results to this website when the unit has been tested. Since this theory fits right into the already established doctrine of Viktor Schauburger, I feel that we just may have a working “Whirlpower” machine in the very near future. Rest in peace, Mr. Dennard...your work will not be forgotten. FDG

[Back to INDEX of Frank.Germano.com](#)

[Back to the Viktor Schauburger page](#)

amazon.com
and you're done.™

**Shop
Now &
Save**

[Click here](#)

[Privacy Information](#)

- [Electronics](#)
- [Books](#)
- [Music](#)
- [DVD](#)
- [Video](#)
- [Toys & Games](#)
- [Today's Deals](#)
- [Kitchen & Housewares](#)
- [Tools & Hardware](#)
- [Computer & Video Games](#)
- [Outdoor Living](#)
- [Apparel & Accessories](#)
- [Camera & Photo](#)
- [More...](#)

- END -

THREE: Water Resources

[\[back to INDEX\]](#)

To add a little twist to your water research, try some of these excellent books!

On the Track of Water's Secret

by Hans Kronberger, Siegbert Lattacher (Photographer), Ann Dubsky (Translator), Lois Lammerhuber

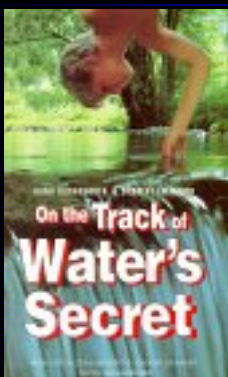

List Price: \$14.95

Our Price: **\$14.95**

 Buy from **amazon.com**

[Editorial Reviews](#)

[Book Description](#)

Perhaps the only book of its kind, *On the Track of Water's Secret* is a journey into a realm where water actually has a "memory". Not only can this water retain information, but it can even transfer this information to larger bodies of water, benefiting all living creatures who come into contact with it. This "revitalized" water has the ability to break down calcium deposits in water, thereby softening it, possibly eliminating the need for water filters. It has also been shown to keep fruits and vegetables fresher longer, kill bacteria and aid in various health ailments for those who drink it or use it externally. The author backs up his claims with experiments, pictures and testimonials from the many people who have seen the benefits of "revitalized" water first-hand. **From the Back Cover** For years, frontier scientists and naturalists have been attempting to use the fact that water has a "memory" and is capable of transferring information, to restore our planet's water back to its original healthy, vital state. Such revitalized water has been shown to render many chemicals bio-inactive, to break down the calcium deposits and make water 'softer', to further revitalize larger bodies of water, and to be healthier for all living things...

Pyramid Power : The Millennium Science

by G. Patrick Flanagan, Nick Begich



List Price: \$14.95

Our Price: **\$11.96**

You Save: **\$2.99 (20%)** **Expanding Knowledge**, May 18, 2001 Review:

This book is one of many products created by the genius of G. Patrick Flanagan for the betterment of the human race, the expansion of our awareness. It is laid out in a context of terse sayings for easy grasp and memory banking, begins by referring to the myriad approaches to total knowledge we've held onto through language and philosophy and scientific analysis and exploration throughout the ages. After one reading the mind has increased in its capacity to understand and intuit real knowledge. Patrick takes the reader step by step to his final conclusions via

scientifically supported objective reasoning including photographs and diagrams. He transmits his own intelligence via the choice of language and ideas he focuses on--it warrants many readings or keeping for reference!

Towards a New Alchemy : The Millennium Science

by Nick, Dr Begich, Patrick Flanagan (Illustrator)



List Price: \$14.95

Our Price: **\$11.96**

You Save: **\$2.99 (20%)**

Editorial Reviews

Midwest Book Review

The ancient works of alchemy are transformed from the oldest arts to leading edge science. Exchanging elements and energy into new orders of matter. Towards A New Alchemy: The Millennium Science transcends this present age into the next renaissance in thinking and science. The present state of technology will open the next millennium with incredible possibilities. with electronic telepathy, microclusters

technology, computer to human communications, new breakthroughs in electro-medicine, the discovery of subtle energy in geometries, holographic sound projection and speed learning, English communication with U. S. Navy dolphins, new science directions for the future, and more! Towards A New Alchemy is page-by-page fascinating reading, a thought-provoking, visionary, and inspiring compilation. If you've heard of Patrick Flanagan, and know anything at all about his numerous accomplishments (from child progeny to adult genius), then you're probably curious about how he discovered such things as the Flanagan Neurophone and the ultimate unveiling of his most advanced discovery to date: the secret of superior health and longevity behind Hunza water, and how he has re-created it in the form of "Flanagan Microclusters". Anyone familiar with the revolutionary products called "Microhydrin", "Crystal Energy", or the Neurophone will be thrilled with the details given about these and other interests in Patrick's life.

Universal Laws Never Before Revealed : Keely's Secrets : Understanding and Using the Science of Sympathetic

by Dale Pond, Nikola Tesla, John W. Keely

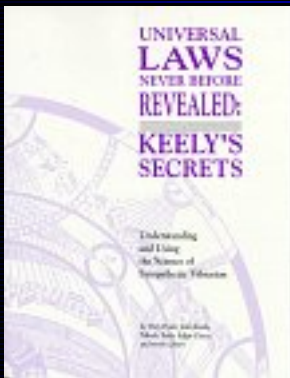

List Price: \$19.95

Our Price: **\$19.95**

What is Sympathetic Vibratory Physics? It is the science of Harmony, of Oneness. It holds the concept that all comes from One Source, One Force. It maintains that the fantastic array of things and activities throughout the universe

are related in a simple manner. This simple basis of relativity is called vibration. It has been long recognized that everything in the universe vibrates. Thus, a study of vibrations is the study of the very foundation of Nature. For once we grasp the inner functioning of the vibratory Universal Creative Forces as they operate throughout the universe, then, and only then, can we correlate them into a comprehensive paradigm and bring them into practical modes of usefulness for the benefit of mankind. Unlike dogmatic, cold science, Sympathetic Vibratory Physics does not isolate one phenomena from another but accepts and shows the inter-connectivity between all things and forces. This interconnection between all things is vibration and related vibratory phenomena. To understand vibration we must develop a comprehensive organized science of vibration governed by laws and principles. Fortunately a great deal of this development work has already been done. We have a well developed science of music. Music is an organized art and science of vibrations found within the audible range of the infinite **Electromagnetic Scale**. A major segment of **Sympathetic Vibratory Physics** is therefore a study of music, its arithmetical and philosophical basis of development and how these may be applied to procedures for inventing new and useful devices and processes. Sympathetic Vibratory Physics focuses on the inner nature of vibratory phenomena. It is well known that vibratory activity contains within itself many differing characteristics and phenomena. These include: amplitude, velocity, mode, sympathy, number and periodicity. Each of these characteristics can be regarded as independent factors as they are generally considered in conventional solutions. However in order to have validity within an integral synapses they must be considered as parts of a whole. In a holistic paradigm each of these characteristics or components must be considered as being relative one to the others. This viewpoint is generally referred to as the Law of Relativity. No thing can be considered of and by itself as no thing in the Universe is isolated from interactions upon or by something else. The isolation of one phenomenon from all others is science's greatest mistake. Until this error in thinking and practice is corrected we will continue to experience deleterious effects of our scientific endeavors. **Sympathetic Vibratory Physics** gives us a broad field in which all things can be studied as relative parts of a comprehensive whole. Through the study of music and music development we have this relativistic paradigm. The fundamental principle of music is relativity. A simple frequency is nothing of and by itself. But relate that frequency to another and we instantly have two separate entities locked together by a fixed interval between them. This relationship is always expressed as a ratio or the relative values rigidly fixed in a given relationship known as an interval. Herein lies the hidden power of **Sympathetic Vibratory Physics as developed by John Keely**. A concordant waveform, composed of harmonic frequencies, tends to pull subatomic particles together. On the other hand discordant waveforms will tend to split or explode the particle or aggregate. A simple analogy is that of dynamite, a harmonious substance when at rest, one which is held together by the molecular and atomic component frequencies. The introduction of a strong introductory impulse from a dynamite cap destroys it's homogeneous integrity and the component subatomic particles are liberated from their bonds. **Keely explained the relationship between matter and force thusly: "There is no dividing**

of matter and force into two distinct terms, as they both are ONE. FORCE is liberated matter.

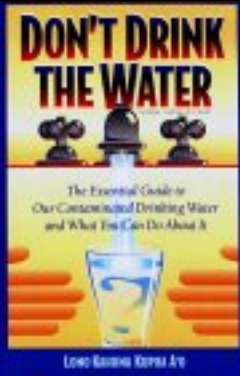

Don't Drink The Water (without reading this book) The essential Guide to Our Contaminated Drinking Water and What You Can Do About It

by Lono Kahuna Kupua A'O, Lono Kahuna Kupua A'O, Lono A'O, Susan Tinkle (Editor), Thomas Grignon (Illustrator)

I just got finished reading this book in between classes, and all I can say is WOW! Be aware, and beware of your tap water. If these statistics are correct, then the EPA and the U.S. government are not concerned with protecting your right to clean water, and therefore, you must educate yourself in order to protect against degenerative disease. [1991-1992 EPA records showed that the nations water systems committed over

250,000 violations of the Safe Drinking Water Act, affecting more than 100 million Americans - and 10% of those exceeded the MCL (Max Contaminant Level) of the EPA.]. This book is a great start finding out the truth of the matter. Toxins are everywhere! We all need to learn where they exist and remove them for our own and our children's sake. Someday, a high ranking official on TV may review this book, or a similar subject and try and spin these numbers a certain way to make it not sound so bad, but don't be fooled. Statistics seldom lie. Only politicians do. Politicians can come from any field, not just government. Politicians come from industry, medicine, lobby, and big business etc. Be a detective, and look for anything that doesn't make sense. "The Truth is Obvious, Everything Else is Questionable"

The Sierra Club Guide to Safe Drinking Water

by Scott Alan Lewis

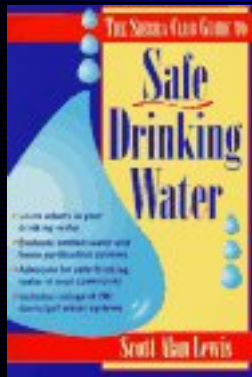

List Price: \$10.00

Our Price: ~~\$10.00~~

Editorial Reviews

Amazon.com

Books on healthy, organic eating proliferate, but the topic of water isn't as popular. You can always buy bottled, but Lewis' takes on the issue in all its complexity. He describes the myriad contaminants, and lists city violations. He tells how to purify your water and the possible illnesses incurred if you don't. It's not a pretty story, but

someone needs to tell it, and Lewis does the job well. **From Booklist** - For an incisive overview of water-quality concerns, it would be tough to beat this slim volume. Lewis not only enumerates the problems common to U.S. drinking water but also considers remedies ranging from home treatment to global strategies to preserve the total water supply in a healthy condition. Although its various appendixes and tables are impressive, the most attractive feature of the book is chapter 4, "The City List," a summary of all Safe Drinking Water Act violations reported by the EPA. Clearly and interestingly traces the causes and sources of drinking water contamination. Allows even the laxest of readers to quickly grasp the scope of the problem. Plenty of details on how to test your water and how to correct problems that have been detected. Unfortunately the drinking water supply across the US is not as clean as it should be to adequately protect the health of those who rely on it. Anyone who cares about their health should read, and use, this outstanding book.

The Healing Energies of Water

by Charlie Ryrie

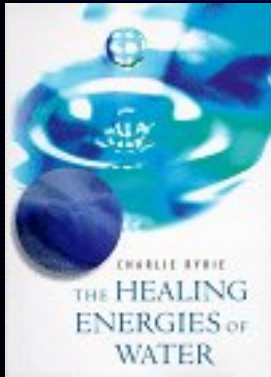

List Price: \$17.95

Our Price: **\$14.36**

You Save: **\$3.59 (20%)**

This valuable book points out lots of things that we maybe always knew as well as informing us about lots of new aspects such as the memory of water and how this affects all the water in the world and in our bodies. It links humans with a watery world in an intelligent way to give a fascinating overview of the whole subject of water, looking at traditional sacred views of water through conventional scientific analysis into esoteric or less well-known ones. And it gives lots of up to the minute

information about healing with water, both through healthy drinking practices and bathing. It added a dimension to the overall learning of that modality that I would have missed without it. Just as we seem to be disconnected from our own bodies-and take them largely for granted, so have we lost what this book brings back to us. Information about water on many levels is presented in a beautiful and readable format. It makes some esoteric concepts very accessible and recreates a relationship to this element that creates an renewed appreciation for what it means to our lives.

[BACK TO INDEX](#)

FOUR: Natural Homes; ecologically sensible living

[back to INDEX]

Below are books that are simply fantastic in the "new", environmentally friendly, home arena...

I've assembled the best of the best, in terms of all the books available. Check 'em out for yourself.

Keep this page open in your browser. It's much easier to scan through all of the books!



The first section I have included is on the "Earthship" building style. ***Click on the picture to the left to see the style of home that I am building in the near future.*** Order the books below, which will give you the basic knowledge necessary for building your own, independent home. Although I am in total agreement to the concepts of the "Earthship" building process, I have augmented on the construction with one MAJOR addition - no matter what the books may say, there is NO thermal mass associated with old tires filled with sand! Take the time to visit the website of the "Earthship" (<http://www.earthship.org/nav/index.htm>), and review it carefully (I suggest that you keep this browser window to my site open, and order the books through "Amazon.com", as the prices offered for the books are much lower than anywhere else that you will find!)...after you've been "hooked" on the building concept...take it a step further, and add some thermal mass to your home - by using poured CONCRETE and STONE to form your walls and foundation - this offers true THERMAL MASS! You can view an extraordinary website for truly "off-grid" passive solar homes and living at: <http://www.thenaturalhome.com/index.html>...this is the type of home that is pictured to the left.

The Natural Home Building Source

This is also the type of home that I , myself am building. I have taken most of the concepts provided

through many years of research, from the "Earthship" type of building style, to passive solar homes, underground houses, solar-electric concepts, and, by combining this with "Archetara" (The Natural Home Building Source) and their truly revolutionary plans and concepts, I will end up with a distinctive, beautiful "off-grid" passive solar sustainable home, with a Tesla Turbine powering my primary back-up generator, of coarse ;) . I hope you enjoy all of the books offered. I wish you success with your new home building project. FDG

Here are the books for the "Earthship" building process:



Comfort in Any Climate by Michael Reynolds

 Buy from [amazon.com](#)

List Price: \$19.95

Our Price: **\$13.96**

You Save: **\$5.99 (30%)**

Comfort in Any Climate is about creating a comfortable space in any climate without the use of fossil fuels for heating and cooling. The book describes the difference between thermal mass and insulation, and how to apply these building components to a passive solar design. Comfort in Any Climate breaks down important sustainable design concepts into clear, easily understood elements: thermal mass, insulation, heating, cooling, and ventilation. Michael Reynolds, the author, has been designing and building sustainable buildings around the world for over thirty years. Based on this experience, the author uses architectural diagrams to show how buildings can tap into the temperature of the earth and relate to the angles of the sun. The book presents design variations from extreme cold to extreme heat, and addresses wet and dry climate considerations. Using examples of built Earthship designs, the author shows application of the presented concepts through text, illustrations and color photos. This book should be read by any person thinking of building or buying a home. It is informative to architects, builders, educators and any person interested in reducing their fossil fuel consumption. Includes eleven pages of color photos and architectural drawings that illustrate the beauty of buildings that passively heat and cool themselves, without the use of fossil fuels. Imagine a home that takes care of itself with no utility bills!



Earthship : Evolution Beyond Economics

 Buy from [amazon.com](#)

by Mike Reynolds

List Price: \$24.95

Our Price: **\$17.46**

You Save: **\$7.49 (30%)**

Part 1, Evolutions...Chapter 1; Structure: Concrete and rammed earth half blocks. Aluminum can/ concrete bond beam and rebar pinned plates. Homemade trusses. Cold area ground insulation. Tire retaining walls and wing walls. Applications to steep land. New gutter details.

Floors - mud and flagstone. Finishing Earth cliffs. Hanging Earthship doors. Round and arch windows. Homemade operable windows. Adding on a U module. Chapter 2; Mechanical: Indoor water cisterns. Water Organizing Module (WOM) Interior, Contained Greywater Treatment Planter, Power Organizing Modules (POM), Back propane heater. Part 2, New Components & Concepts...Chapter 3, Thermal Mass Refrigerator...Chapter 4, Solar Toilet...Chapter 5, Solar Oven/Distiller and electric cook top... Chapter 6, Straw Bale Temporary Structure...Chapter 7, Retrofit Applications, Part 3, Community & Urban Concepts...Chapter 8; Exploring Community Concepts...Chapter 9; Urban Earthships, Part 4, New Directions...Chapter 10; A Tire Building Code...Chapter 11; Aluminum Can Dome Pods...Chapter 12; Climatic & Site Adaptations...Chapter 13; The New Generics. This is a very good book

encompassing the Earthship theories.

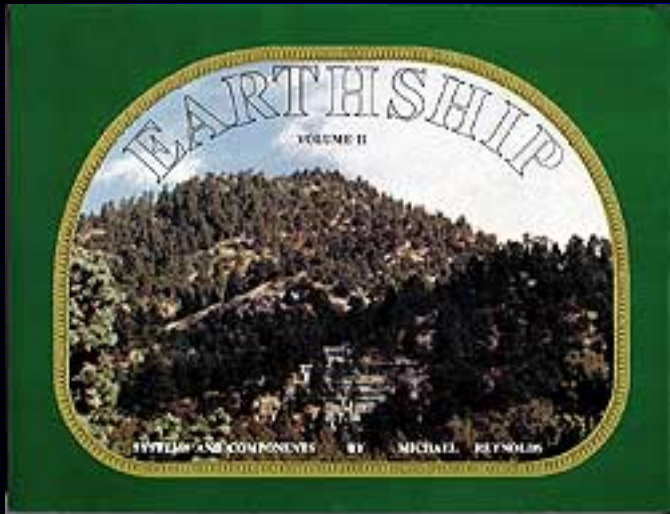

Earthship : Systems and Components

 Buy from **amazon.com**

by Michael Reynolds

List Price: \$24.95

Our Price: **\$17.46**

You Save: **\$7.49 (30%)**

Chapter 1, Solar Electric Systems, The operation of a sailboat requires an understanding of the concepts and schematics of sailing and knowing the patterns and nature of the wind. There are many differences between the operation of a gasoline powered speed boat and a

wind powered sailboat. The major difference is that in a sailboat you will never run out of gas. Other differences involve pollution, noise, wear and tear, and repair of moving parts. The differences between conventional electricity and solar electricity in a home are similar to the difference between a speed boat and a sailboat. This chapter will cover the concepts and schematics of solar electric systems for Earthships. It will also discuss how to use a solar electric system relative to the patterns and nature of the sun, as discussed in chapter 2 of Earthship Volume I. Little attention will be given to specific wiring details, as these are covered in many electrical wiring manuals already in print (see Appendix, Chapter 1). The objective here is to provide the Earthship owner with an understanding of the nature of solar electricity, how it is collected and stored, and how to live with it. Chapter 2, Domestic Water Systems, In these times it is best to have and to be in control of your own water supply. Most city, town and community water systems (in addition to providing "questionable" water) are dependent on electricity for obtaining and delivering water. This makes the water dependent on commercial electricity. Commercial electricity looks unreliable for the future even if you can overlook the devastation that producing centralized commercial electricity brings. Therefore an Earthship must have its own water systems. This chapter will cover ways of acquiring and delivering water that use minimal or no electricity. As in the previous chapter the focus will be on the methodology and concept in an attempt to establish a clear understanding of how to get good water for domestic use. The equipment needed will be discussed but actual installation of the equipment, which involves conventional plumbing and mechanical skills, will be assumed to be within the grasp of local mechanical contractors and other consultants. Chapter 3, Waste Water Systems, With the given fact that water is becoming more and more precious due to careless consumption, contamination, and sheer numbers of humans on the planet, we must totally rethink what we do with waste water. The truth is there will be no such thing as waste water. This chapter will cover methods and concepts involved in recapturing and reusing all domestic water that is used in the dwelling. Chapter 4, Hot Water Systems, We have grown accustomed to the availability of all the hot water we can use. Maybe it is time to look at the reality of how much hot water we need. The Earthship Volumes are aimed at simple, comfortable survival not luxurious American decadence. There are many ways to get endless amounts of hot water for domestic purposes. There are but a few that are both economical and appropriate when one considers the numbers of people and the current condition of the planet in terms of extracted energy. Therefore, we will only discuss the few simple methods of obtaining hot water that, after twenty years of research in self-sufficient living, still look desirable both economically and ecologically. As with the previous chapter, we will first present a method of free hot water production

which requires some personal changes of habit and attitude, then a method that comes a little closer to what we are accustomed to but is the lesser of the evils, so to speak. As for all the other methods of obtaining endless amounts of hot water, there are other books. Chapter 5, Lighting Systems, "And God said let there be light and there was light." Man said, let there be light and there were nuclear power plants, ugly power lines and radioactive waste. Lighting has become an expensive, (ecologically and economically) energy consuming endeavor in conventional housing. The objectives of Earthship lighting are to seriously reduce both expense and energy requirements for providing domestic light. In many cases the reduction of energy use has resulted in an increase in expense. This is because many of the new solar electric products do not have a large enough market to bring down the prices to a competitive and reasonable level. Another factor is that there are so many direction to go in terms of lighting (AC versus DC, incandescent versus fluorescent, etc.) and each direction has its own situation. The bottom line is that, at this point, no standard, simple, inexpensive direction for lighting has been established for solar dwellers. The purpose of this chapter, therefore, will be to establish this direction and to present the concept and equipment for simple, inexpensive "off the power grid" lighting. Chapter 6, Adobe Fireplace components, Most houses are kept too warm (at the expense of the owner and the environment) by their various heating systems. It is much more healthy to keep an interior environment just a bit on the cool side.



Earthship : How to Build Your Own

 Buy from **amazon.com**

by Michael E. Reynolds

List Price: \$24.95

Our Price: \$17.46

You Save: \$7.49 (30%)

Chapter 1, The Determining Factors of the Earthship Concept, This chapter will elaborate on and develop the "independent vessel" concept as a necessary spark toward the evolution of habitat on this planet. Chapter 2, Interfacing with local phenomena Location In the Northern Hemisphere, moss grows on the north side of trees and snow melts on the south side of mountains. If you want a log to float downstream, you must place it in the current, not near the shore in an eddy. Earthships must also be placed for optimum interaction with natural phenomena. This chapter explores the natural phenomena of the planet and explains how to interface an Earthship into the existing phenomena of the area. Chapter 3, Following the directives of concept and natural phenomena Design Fast cars are designed in wind tunnels, i.e. the wind dictates the design of the car. Likewise, natural phenomena dictate the design of an Earthship. The design schematic of existing Earthships is presented in this chapter as it relates to local phenomena. Within these parameters, personal needs and desires are dealt with. The issue of performance versus tradition is discussed from the perspective of "Live simply so that others may simply live." Chapter 4, The Skeleton of the vessel Structure Economy and availability to nonprofessional builders are important determinants of an Earthship structure. This chapter presents the simple structural integrity of existing prototype Earthships via conceptual diagrams, photographs and three dimensional drawings. This structural system is both designed and explained in terms to which the nonprofessional builder can relate. Chapter 5, The Primary building blocks of the vessel Materials The nature of the materials used to execute an Earthship design is explored. The earth-rammed automobile tire is

Chapter 1, The Determining Factors of the Earthship Concept, This chapter will elaborate on and develop the "independent vessel" concept as a necessary spark toward the evolution of habitat on this planet. Chapter 2, Interfacing with local phenomena Location In the Northern Hemisphere, moss grows on the north side of trees and snow melts on the south side of mountains. If you want a log to float downstream, you must place it in the current, not near the shore in an eddy. Earthships must also be placed for optimum interaction with natural phenomena. This chapter explores the natural phenomena of the planet and explains how to interface an Earthship into the existing phenomena of the area. Chapter 3, Following the directives of concept and natural phenomena Design Fast cars are designed in wind tunnels, i.e. the wind dictates the design of the car. Likewise, natural phenomena dictate the design of an Earthship. The design schematic of existing Earthships is presented in this chapter as it relates to local phenomena. Within these parameters, personal needs and desires are dealt with. The issue of performance versus tradition is discussed from the perspective of "Live simply so that others may simply live." Chapter 4, The Skeleton of the vessel Structure Economy and availability to nonprofessional builders are important determinants of an Earthship structure. This chapter presents the simple structural integrity of existing prototype Earthships via conceptual diagrams, photographs and three dimensional drawings. This structural system is both designed and explained in terms to which the nonprofessional builder can relate. Chapter 5, The Primary building blocks of the vessel Materials The nature of the materials used to execute an Earthship design is explored. The earth-rammed automobile tire is

presented as the most appropriate method for its strength, economy, lack of skill needed, and the fact that it makes use of an otherwise discarded "natural resource." The aluminum beverage can used as a masonry unit for filler walls is also presented for similar reasons. Chapter 6, The details and skills used to build the "U" module The "U" Module The fundamentals of how to build your own Earthship are presented here. A well illustrated and explained collection of easy to learn skills, available to all types of people of various strengths, shapes and sizes is presented. This includes how to lay the rammed earth tires, how to lay the aluminum cans in mortar, connections, mistakes commonly made, etc...

After you have dug your way through all of the information on ["Earthships"](#), and visited the ["Natural Home - Archetara"](#) website, and now wish to be your own...your on your way to a lifestyle that is ecologically sensible, practical, and sustainable. Hope you enjoyed the information.

FIVE: Environmentally friendly building styles



Save \$20 on your first purchase at Amazon.com
earn **Free Rewards**

[Learn More](#)
[Privacy Information](#)

[\[back to INDEX\]](#)

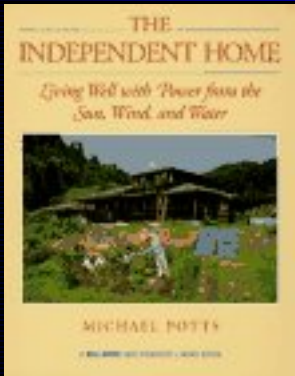

The Independent Home : Living Well With Power from the Sun, Wind, and Water (A Real Goods Independent Living Book)

by Michael Potts, John Schaeffer (Designer)

List Price: \$19.95

Our Price: \$15.96

 Buy from **amazon.com**

Editorial Reviews

Whether you already own a home or plan to build one, The Independent Home will show you how to transform it into an energy-efficient, comfortable, self-sustainable home of the future-- right now. Michael Potts's home has been featured on the ABC evening news as an example of the sane approach to simple living; he demonstrates how one can live well, save money, save resources, and still retain modern conveniences and comfort. The Independent Home proves that it is not necessary to live in mud-floored huts and cook brown rice over a campfire to go back to the land

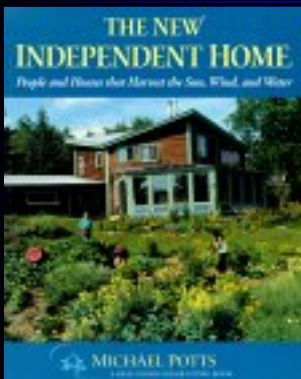

The New Independent Home : People and Houses That Harvest the Sun

List Price: \$30.00

Our Price: \$21.00

You Save: \$9.00 (30%)

[Editorial Reviews](#)

 Buy from **amazon.com**

The author, Michael Potts , December 18, 1999: My book helps folks take control of their energy destiny

It took me 20 years to get ready to write my book -- tinkering, visiting, figuring arcane technology out -- and then another 6 years to get the book right. Independent homesteaders offer us all lessons on using our energy better. On-the-gridders waste half the energy they buy, while we who carefully harvest every electron, teaspoon of water, and therm of heat, strive to waste as little as possible. This

work reconnects us with the planet in unexpected ways. There are important lessons in my book about phantom loads, free energy sources, and small habit changes that have helped many "on-the-gridgers" reduce their energy bills by 30% - 60% -- enough to pay for their energy improvements with enough left over to buy a new copy of my book (and give it to a friend) every month!

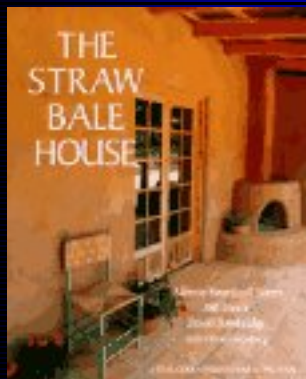

The Straw Bale House.

List Price: \$30.00



Our Price: \$21.00

You Save: \$9.00 (30%): Get a leg up on the first Little Pig with The Straw Bale House, your guide to inexpensive, durable, earth-friendly construction that will stand up to much more than the Big Bad Wolf. Authors Athena Swentzell Steen and Bill Steen founded the Canelo Project, which promotes innovative building;

David Bainbridge is a California restoration ecologist; and David Eisenberg is an alternative-materials builder who pioneered straw bale wall testing. Between them, they have encyclopedic knowledge of their subject. The book is comprehensive, broadly covering why and how to build with straw and then focusing on the details, which are both intellectually and aesthetically delightful. Beside being cheap, clean, and lightweight, straw also provides advantages like energy efficiency and resistance to seismic stresses. For the nervous Martha Stewart types, there are scads of black-and-white and color plates of strikingly beautiful interiors and exteriors from New Mexico to southern France. Both new and experienced builders will appreciate the clear, simple instructions and diagrams, as well as practical explanations for dealing with building codes and insurers. The Straw Bale House shows us advantages so numerous and dramatic that you'll wonder why we ever moved on to sticks and bricks. --Rob Lightner. From Book News, Inc.; A guide to building living structures with straw bales. Covers benefits of building with straw bales, safety concerns, building codes, and insurance, and offers techniques for building walls, windows, doors, foundations, roofs, floors, and plastering the straw walls. Includes b&w photos demonstrating building techniques, and color photos of finished homes and interiors. Annotation copyright Book News, Inc. Portland, Or.

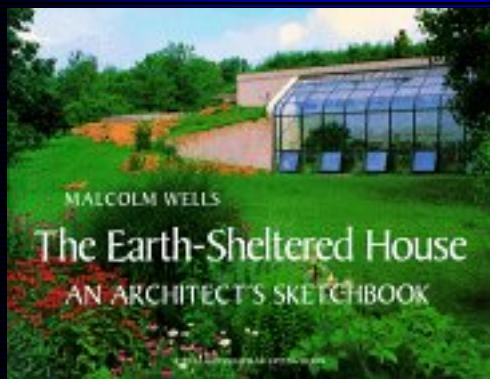

The Earth-Sheltered House : An Architect's Sketchbook (Real Goods Solar Living Book) by Malcolm Wells,



Editorial Reviews

The striking common sense of the author's perspective on design and the building process is based on millennia of use of earth-sheltered homes by animals and humans, using the earth to warm in winter and cool in summer. A cartoon on the book jacket summarizes Wells's perspective. One panel is called "20th Century," and has four steps of traditional building: love nature, kill it, build building, plant grass. The second panel, called "21st Century," says: love nature, leave it alone, find ruined land, build underground, restore natural habitat. Wells's remarkable and imaginative architectural drawings, sketches, and landscaping and structural design plans are

surrounded by his handwritten commentary about Earth-friendly building and design, cryptic remarks and humorous asides that make this book a pleasure to browse or read cover to cover. He offers a breathtaking assortment of some of the most creative and unusual home and building designs ever assembled in one book; site-appropriate structures for both urban and rural settings; and delightfully imaginative, dramatic, simple, and highly complex buildings for all purposes. Some are fully underground structures, some partially earth-sheltered, but all make the best use of light sources, designed to benefit from the sun and seasonal changes, and to protect or restore the natural habitat around and above them. Wells's designs seem almost fanciful, but are indeed based on practical considerations and currently usable techniques and materials, helping open up a whole new concept of building based on one of the oldest known: caves and burrows. These are "caves and burrows" of soaring imagination and creative, 21st century brilliance. --Mark A. Hetts

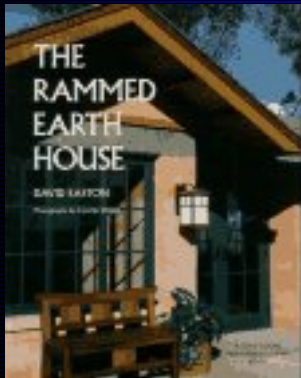

The Rammed Earth House (Real Goods Independent Living Book)

by David Easton, Cynthia Wright (Photographer), David Eaton

List Price: \$30.00

Our Price: \$21.00

You Save: \$9.00 (30%)



Editorial Reviews

The beauty and grace of rammed earth construction is described in fascinating detail by David Easton. The photographs of different structures, both modern and ancient, by Cynthia Wright, create a breathtaking glimpse into a building technique that is as old as human history, but exactly suitable for today's resource-conscious and environmentally friendly building needs. Trees may be getting a bit scarce these days, but there's no current shortage of dirt, the main component of rammed earth homes. From such a prosaic material, gold has been spun in these timeless, graceful, and nearly indestructible homes and buildings.

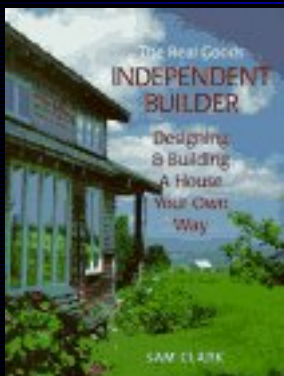

Independent Builder : Designing & Building a House Your Own Way (Real Goods Independent Living Books)

by Sam Clark. List Price: \$30.00

Our Price: \$21.00

You Save: \$9.00 (30%)



Subtitled "Designing and Building a House Your Own Way," this is the book for anyone thinking about building their own home. It is comprehensive, detailed and covers subjects I have never before seen covered in home building books, like how to make a small house seem bigger, incorporating ergonomics and accessibility, doing your own drawings and scale models, making contracts that work, and working effectively with professional designers and builders. With detailed diagrams and

photographs, this is the most thorough overall guide to building your own home I have ever seen (and I've seen a lot!). The author, Sam Clark , February 25, 2000

Strengths of "The Independent Builder"...My book is a comprehensive 500 page treatment on house building, a basic manual useful to owner-builders, families working with professionals, and to builders. I think its strengths include: Technical information, presented clearly, based on underlying principles. For example, along with tables for beam sizes, I give the concepts and formulas so you can figure sizes yourself. Other examples: heat loss, sound isolation, sun angles. I think if you understand the principles, you can design more

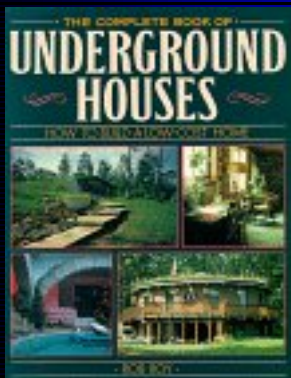

Complete Book of Underground Houses : How to Build a Low-Cost Home

by Robert L. Roy, Rob Roy

List Price: \$14.95

Our Price: \$11.96



According to Roy, underground or "earth-sheltered" houses are unexpectedly livable. Judging by his book's attractive pictures, that's easy to believe. The house he bases his point-by-point guide on is indeed a showplace. Its homey touches are just that, though, and Roy's main concern is creating such a house, from drawing up the plans to surveying the site to the actual building. Roy's instruction is insightful and comprehensive; for example, he writes that he has poured the four-inch cement floor over the waste plumbing in all the houses he has built and has had no trouble yet, but he also suggests another strategy for those leery of not being able to get at the pipes in an emergency. Throughout, he covers construction and installation details that are extremely important for nonprofessionals brave enough to undertake building their own homes. Mike Tribby From Book News, Inc.

Instead of marring a grassy knoll or field with the construction of a conventional house, you could design and build an environmentally sound underground or earth-sheltered home. Roy, director of the Earthwood Building School, provides detailed instructions, from choosing a piece of property to excavating and building a home from top to bottom, with case studies, photos and diagrams, and further resources.

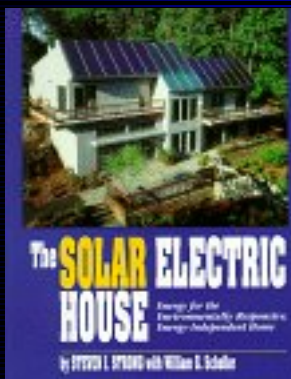

The Solar Electric House : Energy for the Environmentally-Responsive, Energy-Independent Home

by Steven J. Strong, List Price: \$21.95

Our Price: \$15.36

You Save: \$6.59 (30%)



THE most comprehensive solar electric book available, January 30, 1999 . Reviews: Steven Strong's book "The Solar Electric House" is the most comprehensive book available regarding the application of

solar-generated electricity (photovoltaics). The book is well organized, well written, and easy to understand. Although this book was first printed in 1987, it is amazingly current today (1999). I have been using this book since 1987 when I build my stand-alone PV-powered home in Prescott Arizona, and referred to Mr. Strong's book on a regular basis during design and construction of the solar-electric system. I still use this book today -- as the primary textbook in two classes that I teach at Arizona State University: "Introduction to Solar Energy and Photovoltaics" and "Photovoltaic System Design".

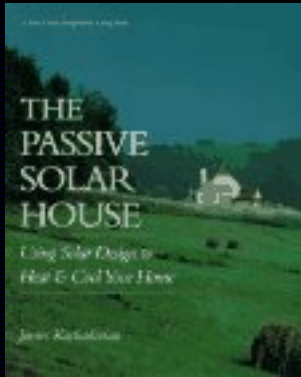

The Passive Solar House (Real Goods Independent Living Books)

by James Kachadorian

List Price: \$24.95

Our Price: \$17.46

You Save: \$7.49 (30%)



This book offers a technique for building homes that heat and cool themselves in a wide range of different climates, using ordinary building materials available anywhere and with methods familiar to all building contractors and many do-it-yourselfers. A formerly patented design for author James Kachadorian's Solar Slab heat exchanger is now available for the use of anyone motivated by the desire to build a house that needs a backup furnace or air conditioner rarely if ever. This is a building book for the next century. Applicable to a diversity of regions, climates, budgets, and styles of architecture, Kachadorian's techniques translate the essentials of timeless solar design (siting a home in harmony with nature, using windows as solar collectors, achieving year-round comfort by balancing good insulation with healthy supplies of fresh air) into practical wisdom for today's new generation of solar builders.

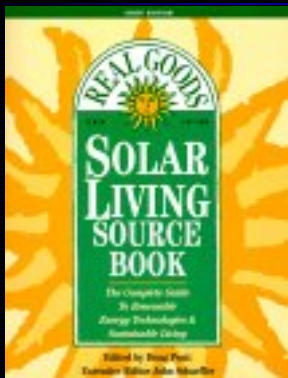

The Real Goods Solar Living Sourcebook : The Complete Guide to Renewable Energy Technologies and Sustainable Living (Real Goods Solar Living Source book)

by John Schaeffer (Introduction), Douglas M. Pratt (Editor)

Editorial Reviews

Amazon.com

It is arguably a form of cultural insanity that industrial civilizations constantly bathed by free and clean energy from the sky (the sun and the wind) continue to depend upon dirty and limited chemical fuels that poison the people, their foods, and the land upon which they depend.

Happily, this comprehensive sourcebook provides those of you with foresight a way out of this madness; it includes products ranging from simple energy-saving devices such as compact fluorescent lights to home-scale energy-harvesting systems that utilize the sun, wind, and water to make electricity for people living "off-the-grid." Chapters focus on Independent Living, Land, Shelter, Harvesting Energy, Managing Energy Systems, Heating and Cooling, Water, Energy Conservation, the Nontoxic Home, Home and Market Gardening, Mobility and Electric Vehicles, and Livelihood and Learning. Committed to selling only products that promote environmental responsibility at an honest value, The Real Goods Trading Company is one of the fastest-growing companies in America. Many of the

products listed in another of my favorite sites, the [Millennium Whole Earth Catalog](#), can be purchased by mail from "Real Goods". [Whole Earth Review](#)
The Sourcebook remains the best introduction to energy-efficient technology for common folks.

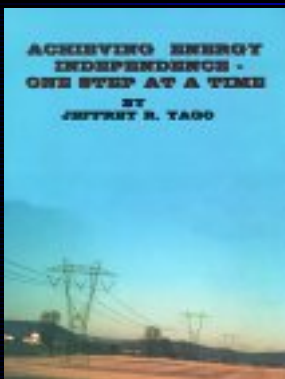

Achieving Energy Independence - One Step at a Time by Jeffrey R. Yago

 Buy from [amazon.com](#)

A must have first text for any homeowner wanting to install a back up power system for their home or home business. Addresses new ways to prepare for power outages including Y2K, brownouts, storm outages, and rolling blackouts. Step by step guide to become independent of the utility grid. Answers all installation questions about solar photovoltaic systems, generators, battery inverters, wind turbines, and battery banks, including wiring diagrams and safety issues.

About the Author

Jeffrey Yago is a licensed professional engineer and certified energy manager, with over 25 years experience in the design of solar and backup power systems throughout the United States and Europe. He has authored two prior texts related to energy conservation and installation guidelines for heating and cooling systems, and his technical articles have appeared in national publications including HomePower Magazine, Mother Earth News, and Solar Engineering.

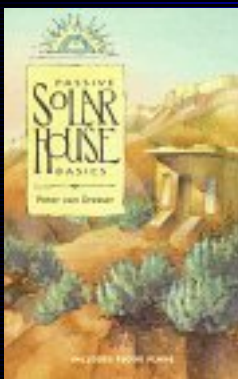

Passive Solar House Basics

by Peter Van Dresser

List Price: \$11.95

Our Price: \$9.56

 Buy from [amazon.com](#)

PASSIVE SOLAR HOUSE BASICS, by Peter van Dresser. Anyone who has visited a solar adobe home on a cold winter day has felt the warmth and comfort of its natural radiant heat. PASSIVE SOLAR HOUSE BASICS lays out in plain language what an owner-builder and designer will need to know about siting, designing, constructing, and living in a solar adobe home. Van Dresser's text and pictures provide a beginner's course in adobe construction and passive solar heat collection, including suggestions for natural heat circulation and heat storage in thermal mass. Included are sample house plans, ideas for solar hot water heaters, and plans-to-scale for solar crop dryers. The simple means he has developed for economically harnessing the energy of the sun in an energy-efficient home are easily within the grasp of the average home owner, home builder, or solar enthusiast. In 1958 solar pioneer Peter van Dresser built his first solar heated house, one of the first in the United States. First published as HOMEGROWN SUN-DWELLINGS, PASSIVE SOLAR BASICS was the outgrowth of a solar demonstration project. Peter van Dresser is the author of LANDSCAPE

FOR HUMANS, as well as numerous articles about solar energy and rural life.

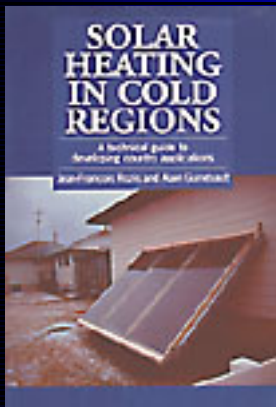

Solar Heating in Cold Regions
by Jean-Francois Rozis Our Price: \$19.50



A technical guide, written for developing countries but no less relevant in the west, for climates where the average annual temperature is lower than 10°C. Contains examples of typical installations and how to size them. The examples are low maintenance and also introduce income generating activities. Anyone living in PA, NY, NJ, CT, VT, MA, or any of the northwestern states would definitely enjoy the practical solutions offered for solar heating your home. 168pp

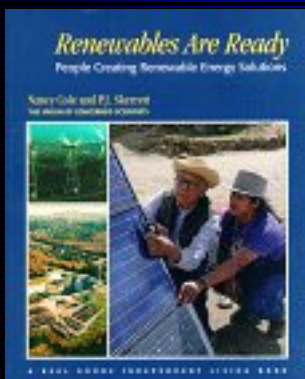

Renewables Are Ready : People Creating Renewable Energy Solutions (A Real Goods Independent Living Book)

by Nancy Cole, P. J. Skerrett Tells the inspirational stories of American who have made renewable energy a reality in their own communities. Renewables are Ready is the first book to document the wide range of renewable energy efforts currently underway.

All of the ideas presented in the book can be implemented in a city, town or neighborhood through individual and group initiatives. Examples include the residents of Austin, Texas, who have turned their city into a national showplace for energy conservation and the use of renewables. 256pp

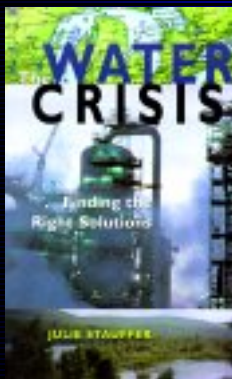

THE WATER CRISIS

Julie Stauffer

Starting with the history of water and ending with a look to the future, this book considers problems caused by urban sewage, intensive farming, acid rain and heavy metals.

Sections on prevention and solutions, includes diagrams and descriptions of the latest treatment techniques and how to use them. 176pp

by Duncan McClaren (Editor), Simon Bullock (Editor), Nusrat Yousuf (Editor) **TOMORROW'S WORLD**
A valuable read for those interested in sustainability. One of the few books which both asks and answers the question of what exactly we need to live a sustainable lifestyle. Useful for those involved in political or community work, such as Agenda 21, or for those simply interested in what we need to do in order to survive for the future. 382pp

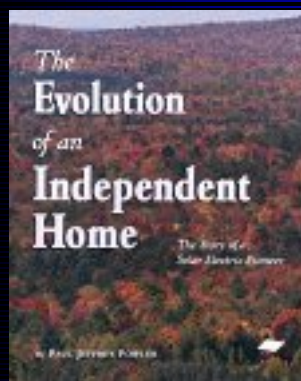

The Evolution of an Independent Home : The Story of a Solar Electric Pioneer

by Paul Jeffrey Fowler

Editorial Reviews

The New Sunpaper, September 1995

Reading this book is like having a good friend tell you how he did it because he hopes his experience will help you to decide to do it yourself.....More than any technical manual could, Fowler's book invites the reader to realize the ideals of building an earth friendly house while encouraging them to appreciate the many facets of what it takes to get the job done.

Rhode Island Solar Energy Association, Summer 1995

This book is for those who want to know how to build a passive solar house powered by a solar electric system. It is a working diary, interestingly written.....and easily understood.

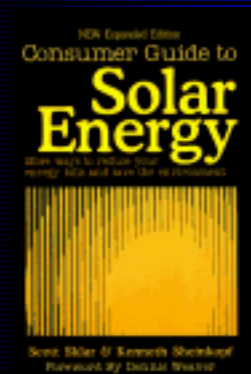

Consumer Guide to Solar Energy : Easy and Inexpensive Applications for Solar Energy

by Scott Sklar, **Consumer Guide to Solar Energy.**, January 7, 2001 Review: This book was quite broad in covering many issues of solar energy. From Heating your house, pool, food, and even providing electricity. It also gave many contacts to seek further information about legal issues, financial incentives, or more information. This is a great beginners book to learn about Solar energy if you know little to nothing about it. If you are looking for detailed information on a particular aspect of solar energy, however, this is not the book. It's a good little reference book though,

especially for the price.

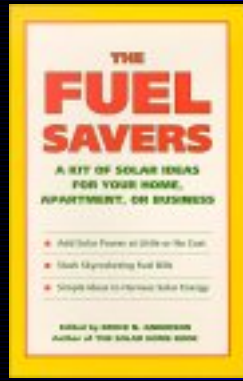

The Fuel Savers : A Kit of Solar Ideas for Your Home, Apartment, or Business

by Bruce Anderson, (Editor)

Editorial Reviews

Paul Hawken, Author "Growing a Business"

A most practical, step-by-step guide for individuals and homeowners to one of the most important issues we face: reducing our wasteful dependence on fossil fuels.

Eric Heitz--The Energy Foundation

The Fuel Savers is truly solar made simple--a friendly guide to solar energy for homes with lots of pictures and good advise. Bruce Anderson's recommendations make sense for the pocketbook and for the environment.

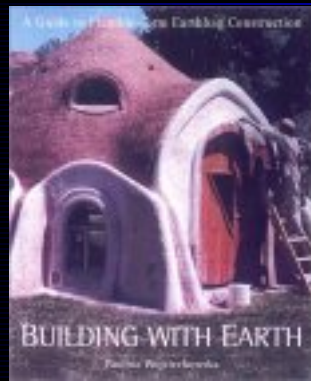

Building With Earth : A Guide to Flexible - From Earthbag Construction (The Real Goods Solar Living Book)

by Paulina Wojciechowska, Bill, Athena Steen

List Price: \$24.95

Our Price: \$17.46

You Save: \$7.49 (30%)



Paperback - 176 pages illustrate edition (May 2001)

Chelsea Green Pub Co; ISBN: 1890132810 ...As with most of the books illustrated, this one is a winner. For the first time builder, to the experienced "pro"...this book will guide you through all of the necessary steps to make your next home an environementally friendly, stunning masterpiece of efficiency and design. Feel like "living" virtually free from utility bills?

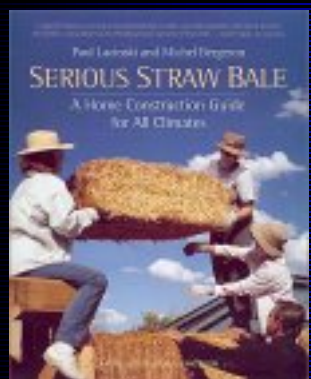

Serious Straw Bale : A Home Construction Guide for All Climates (Real Goods Solar Living Book.)

by Paul Lacinski, Michel Bergeron

List Price: \$30.00

Our Price: \$21.00



This book provides the metaphorical nuts and bolts of straw bale construction for homes and other buildings. Unlike many other straw bale construction books on the market, this one looks at building design issues from the perspective of the straw bale builders and considers the particular needs of the medium. Several different techniques are discussed, focusing much information on the needs of those building in wet and/or cold environments. Many illustrations, some color, and several project profiles

demonstrate the theories discussed. Book News, Inc.®, Portland, OR

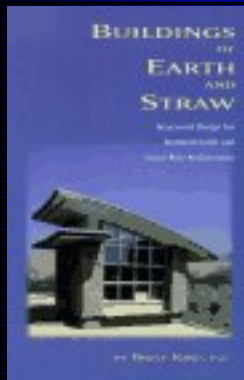

Buildings of Earth and Straw : Structural Design for Rammed Earth and Straw Bale Architecture

by Bruce King, Ann Edminster, (Editor)

 Buy from [amazon.com](https://www.amazon.com)

Chelsea Green's *The Rammed Earth House* and *The Straw Bale House* chronicle the possibilities and realities of straw bale and rammed earth construction. *Buildings of Earth and Straw* fills in the gaps for professional builders, contractors, engineers, inspectors, lenders, and architectural students. It includes special construction requirements of earth and straw, design capabilities and limitations of these materials, and documentation of testing data for use in addressing the concerns of officials. This book offers the nuts and bolts of rammed earth and straw bale building techniques, and why they are so spectacular, durable, and earth-friendly. Straw bale and rammed earth construction techniques are enjoying an explosive growth in interest in the USA and worldwide. Previous Chelsea Green publications such as *The Straw Bale House* and *The Rammed Earth House* have shown the possibilities and realities of the innovative forms of construction. *Building with Earth and Straw* is the essential companion to both, providing technical data from an engineer's perspective. Information includes the special construction requirements of earth and straw, and the design capabilities and limitations of these materials. Bruce King is a structural engineer who has been involved in a variety of innovative building projects. 140pp

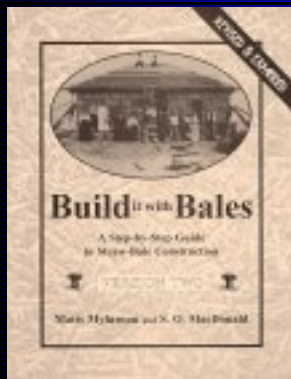

Build It With Bales : A Step-By-Step Guide to Straw-Bale Construction, Version Two

by S. O. MacDonald, Matts Myhrman

THE BEST HOW-TO GUIDE AROUND, March 12, 2000 Reviewer: **Scott Christiansen** from Hong Kong, PRC

 Buy from [amazon.com](https://www.amazon.com)

I highly recommend this book for anyone wanting to know the basics of straw-bale construction. I have worked with the authors in introducing straw-bale construction techniques in a community-development context in Mongolia and China, and I can say from first-hand experience that the authors know what they are talking about (some designs from our Mongolia work ended up in the book). In China, where my organization is working to promote sustainable housing design, I use the book to explain to government officials and others just what straw-bale construction is all about. Because the illustrations are so clear, the book is very useful in this context. I have passed out some 20 copies in China so far, and have had requests for far more. *Build It With Bales* bridges the inspiring beauty of *The Straw Bale House* and the technical authority of Bruce King's *Buildings of Earth and Straw* (see below). This is the indispensable how-to book that takes a designer/builder through the entire process, step-by-step. The book is divided into two logical parts: Part One: Before You Build: · Starting with bales · Three basic approaches · Developing a plan; and Part Two: Building At Last! · The Load bearing Option · The Non-load bearing Option · Surfacing the Walls.

Liberally illustrated with clear, easy-to-interpret diagrams, this book walks you through the building process sequentially, from discerning the differences between hay and straw to applying finishing touches on the wall surfaces. This is an essential manual for any contractor or owner/builder specializing in bale construction. 144 pp

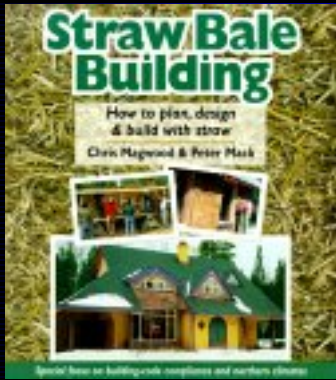

Straw Bale Building

by Chris Magwood, Peter Mack, Elisabeth Ohi (Illustrator), Peter Mack

List Price: \$24.95

Our Price: \$17.46

You Save: \$7.49 (30%)



Straw bale buildings speak to a part of us that insists that we should be able to build our own homes with our own hands. We look at pictures of a bale wall being raised and immediately think: I could do that! Straw bale houses are easy to build, inexpensive, super energy efficient, environmentally friendly, attractive, and - most of all - can be designed to match the builder's personal space needs, aesthetics, and budget. It's no wonder that straw bale houses are growing in popularity. Most straw bale books do a great job enticing us with beautiful photographs and "selling" the idea of straw-bale building - but they don't adequately address the most critical issues faced by bale house builders. In Straw Bale Building, professional bale builders Peter Mack and Chris Magwood lead the potential builder through the entire process of building a bale structure, tackling all the practical issues; from how to find and choose bales; developing sound building plans; costs; roofing; electrical, plumbing, and heating systems; building code compliance and working with building inspectors; and special concerns for builders in northern climates. For those who do not see their lives and their values reflected in "standard" homes, Straw Bale Building offers a wide variety of aesthetic and building options, from multi-storey luxury to elegant simplicity. Over 100 professionally illustrated drawings, plus b&w photos and building plans provide an abundance of creative and practical ideas for novice and experienced builders alike. Down-to earth and complete, Straw Bale Building makes the remarkable benefits of straw bale building available to anyone bitten by the straw bale "bug." Peter Mack and Chris Magwood are professional bale house builders. Together they have constructed 15 straw bale houses and structures. They teach a popular, on-going straw bale building workshop in Ontario, Canada.

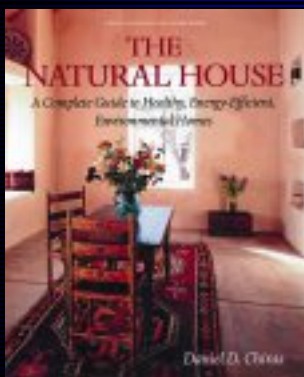

The Natural House: A Complete Guide to Healthy, Energy-Efficient, Environmental Homes

by Daniel D. Chiras

List Price: \$35.00

Our Price: \$24.50



This sourcebook examines the options for building a house that is economical, energy-efficient, nontoxic, kind to the environment, and pleasurable to inhabit. Explores the pros and cons of 14 natural building methods, including straw bale, rammed earth, cob, cordwood, adobe, earth bags, paper Crete, earth ships, and others, all well- illustrated in b&w. Book News, Inc.®, Portland, OR The author, Dan Chiras , July 7, 2000

The Natural House describes 14 natural building techniques.

When people ask me what, The Natural House is about, I say "It's about creating sustainable shelter. That is, it's about creating a dream home that is healthy, kind to Mother Earth, nourishing to the soul, and easy on the pocket book-not an environmental and economic nightmare." The Natural House: A Complete Guide to Healthy, Energy-efficient, Environmental Homes is really three books nestled comfortably within the covers of one.

[BACK TO TOP OF PAGE](#)

[BACK TO INDEX](#)

SIX: Homes by Charles G. Woods

[\[back to INDEX\]](#)

The books below, are from my very dear friend, Architect Charles G. Woods. Besides being one fantastic person, friend and confidant...Charles has a remarkable insight into designing amazing homes, utilizing nature as a "key" and taps in on Frank-Lloyd Wright for some inspiration. Please take some time to review his books...you will not be sorry. If you email Charles, tell him Frank said "hello...and where IS that martini you promised me" ?!

Charles G. Woods



amazon.com[®]
and you're done.[™]

Shop
Now &
Save

[Click here](#)

Privacy Information

- [Electronics](#)
- [Books](#)
- [Music](#)
- [DVD](#)
- [Video](#)
- [Toys & Games](#)
- [Today's Deals](#)
- [Kitchen & Housewares](#)
- [Tools & Hardware](#)
- [Computer & Video Games](#)
- [Outdoor Living](#)
- [Apparel & Accessories](#)
- [Camera & Photo](#)
- [More...](#)



A Natural System of House Design : An Architect's Way

by Charles G. Woods, Our Price: \$59.95

Hardcover - 219 pages (January 3, 1997)

McGraw-Hill Professional Publishing; ISBN: 0070717362 ; Dimensions (in inches): 0.75 x 11.24 x 8.76 Editorial Reviews

[Book Description](#)

Groundbreaking module system simplifies house design. Hailed by

Charles Gwathmey as "both passionate and disciplined," A Natural System of House Design by Charles G. Woods offers you a simple-to-use module "system" of design, developed over a period of 25 years. This expert design tool shows you how to apply a highly adaptable (to rectangles, angles, and curves) 4'0" square module that will be invaluable in both design and construction drawings--and in the construction process itself. Blending philosophy and practical design skills, the book includes dozens of beautiful sample drawings and photos of Woods' own module house designs, both in progress and completed--plus the author's tip on energy efficiency and low-cost design methods, as well as illustrations by Malcom Wells.



Designing Your Natural House (Wiley-Vnr)

by Charles G. Woods, Malcolm Wells (Contributor), David Wright

Our Price: \$55.00

Paperback - 243 pages (January 14, 1999)

John Wiley & Sons; ISBN: 0471285285 ; Dimensions (in inches): 0.55 x 8.36 x 11.02

Excellent overview and comparison of architectural concepts. This book is great for someone who is thinking about building a home with common sense. It explains and compares good and bad architecture, and gives examples and sketches of why it is good and bad. Now when I look at buildings and homes that have always seemed unpleasant, I say to myself "Oh, if the roofline was only at a little less of an angle", and so on. It makes you wake up and be more aware of the aesthetic relationship of a structure to the earth. There are also exciting and innovative home plans in it that you will find nowhere else. The authors respond to inquiries and have a great sense of humor. Seriously: if you are thinking of remodeling, or planning on building a new home...take a look at this book, first. Charles's insight, as well as his practical applications of modern, energy efficient architecture will astound you. You can even have Mr. Woods design your home FOR you! Besides, then you would have the pleasure of meeting him "face-to-face".

The complete earth-sheltered house : passive solar, low maintenance, low cost, modular design
by Charles G. Woods

Natural Architecture : 40 Earth Sheltered House Designs
by Charles G. Woods

The Complete Earth-Sheltered House
by Charles G. Woods

SEVEN: My favorite study Bibles

[\[back to INDEX\]](#)



 <p>How To Enjoy The Bible E. W. Bullinger New \$12.91!</p>	 <p>E. W. Bullinger Juanita S. Carey New \$10.49!</p>	 <p>Commentary on Revelation E. W. Bullinger New \$19.79!</p>
<p>The Transfiguratio E. W. Bullinger New \$5.00!</p>	 <p>The Witness of the Stars E. W. Bullinger New \$10.19!</p>	<p>Ten Sermons on the Second Advent E. W. Bullinger New \$8.99!</p>
 <p>The Second Advent in Relation of the... E W Bullinger New \$2.00! Used \$8.00!</p>	<p>The giver and his gifts E. W Bullinger New \$17.00!</p>	<p>Christ's Prophetic Teaching E W Bullinger New \$5.00!</p>

(Prices May Change) [Privacy Information](#)

Below are my favorite study Bibles

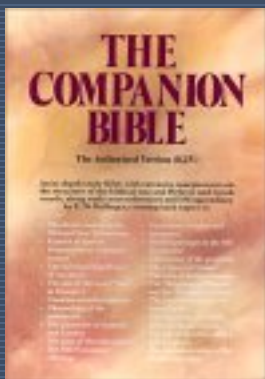

The Companion Bible, by E.W. Bullinger: Thumb Indexed, Black Bonded Leather.

List Price: \$88.99**Our Price:** **\$62.29**

You Save: \$26.70 (30%) This beautiful reference work is excellent ., April 10, 1999 Review:

In this generation where technology abounds and biblical works are polluted with man's traditions, I am glad to see that a great work such as the Companion Bible by E.W. Bullinger remains unchanged. Of course, there may be very small flaws in this work but we must remember that the author was not privy to the prophecy that has

taken place since its' writing. To the beginning Christian, this work offers a great amount of knowledge in providing you a plan on how to study our Fathers word as well as providing a excellent study on the meaning of Hebrew, Chaldea, and Greek words that have different meanings than what the English rendition would have you to believe. To the in depth student or scholar it provides a excellent source for studying the languages and meanings since it brings in to play text from the MASSORAH and

figures of speech that are sometimes misunderstood. It also provides a section of appendixes which are rich in research and information from the only CHRISTIAN SCHOLAR that GINSBERG allowed to proof read the MASSORAH. Take it from a student and a follower of our Fathers word when I tell you that this work along with a good Strong's Exhaustive Concordance of the Bible is invaluable. It is like having a set of the original manuscripts that our Fathers word was translated from. God Bless you all

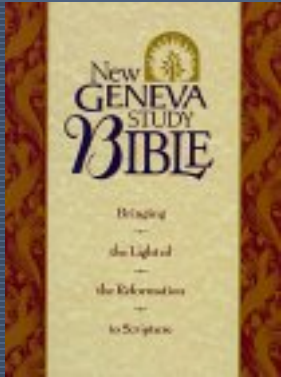

The Geneva Study BIBLE: Editorial Reviews

Our Price: \$69.95
Book Description

The first Geneva Bible opened the pages of Scripture to readers in the vernacular of the day and provided helpful notes to assist the laity in understanding its message. The New Geneva Study Bible, under the editorial leadership of reformed scholars such as R. C. Sproul and J.I. Packer, offers a modern restatement of Reformation truth. The NGSB was a great addition to my personal library. Not only is the NKJV incredibly easy to read and less watered down than most popular Bibles it is closer to the original than most. I would recommend the NGSB not only for the version it is written in but also because it contains excellent reference notes and scripture explanations. For any reformed Christian who desires to get more in-depth in their personal walk with our Living Savior I would challenge them to view or purchase the NGSB and see for themselves. Taste and see how sweet the Word of God is through this well prayed for text. R.C. Sproul is an incredible teacher of the scripture and it is all laid out for the reader in the NGSB...I've been using study bibles for two decades and I've *never* found a better one. Finally, we have a fully theologically-sound, Grace-centered study bible, with notes and essays from the best scholars (Packer, Sproul, Boice, etc.). Everyone in my church either has one or is getting one.

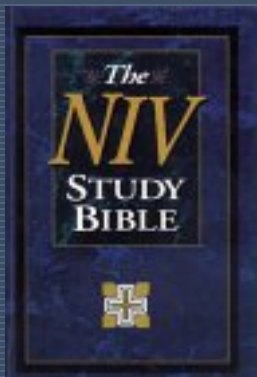

NIV Study Bible, Black Top Grain Leather Indexed

by Kenneth L. Barker, (Editor)
List Price: \$89.99 Our Price: **\$62.99**

This limited edition is part of the Fall '99 NIV Bible Sale. We are only printing 25,000 units.

Feature for feature, The NIV Study Bible is far and away the finest study Bible available. It is like getting a Bible and a reference library (concordance, atlas, chart book, Bible survey book, topical reference, and a verse-by-verse commentary) in one easy-to-use volume. The NIV Study Bible, which has sold over 4 Million copies, combines the world's best-selling Bible translation--the New International Version--with an astonishing wealth of information. Its 20,000 notes, in-text charts and maps, and comprehensive book introductions have made it a favorite, keeping it on the Bible best-sellers list since its release over 11 years ago. This limited edition will meet the needs of customers who want the full-featured NIV Study Bible in a durable, affordable binding. Since it makes a perfect

Christmas gift, it will be a main feature of the NIV Christmas Sale this Fall. This edition is available only as a one-time print run of 25,000 units.

* 20,000 in-text study notes * 100,000 center-column cross references * 80 in-text charts and maps * 62-page subject and note index * 23 pages of full color maps and timelines * A 145-page concordance * Comprehensive book introductions and outlines * Archaeological and historical backgrounds * Study icons * The words of Christ in red * The world's best-selling Bible translation: the NIV

The Bible As It Was

by James L. Kugel

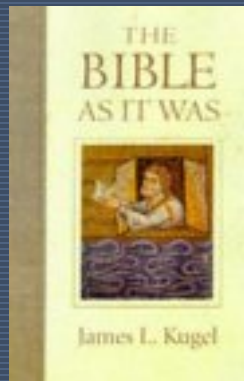

List Price: \$35.00

Our Price: \$24.50

You Save: \$10.50 (30%)

The New York Times Book Review, Phyllis Trible

Interpretation is as old as Scripture itself.... Kugel, the Star Professor of Hebrew Literature at Harvard University, shows that what Scripture began, its readers continued. His main purpose is to provide a detailed look at how the Torah, the first five books, was interpreted in antiquity, most particularly from the third century B.C.

through the first century A.D.

James Kugel's *The Bible As It Was* is an eye-opening study of early scriptural interpretation. Kugel focuses on readings of the Torah (the first five books of the Hebrew Bible) from 100-300 A.D., particularly the Jewish tradition of midrash--a practice of filling in the narrative gaps where biblical stories are ambiguous or unclear. Kugel's interest in midrash is more than academic, however. He wants readers to consider the ways these early readings of the Bible affect today's popular understandings of scriptural texts (such as the sacrifice of Isaac or the creation in Genesis); and he provides a convincing description of the richness and complexity that informs what seem to many like simple, commonsense readings of scripture. "The Bible as it was" is a wonderful and exhaustive work regarding scriptural interpretation and the first five books of the Bible. Early Jewish tradition was to fill in interpretive information when necessary to resolve items that were ambiguous or unclear. In addition, notes and commentary were often passed along with the texts and over time tended to become a part of the text. As a result, the Bible of today includes a lot of commentary as well as the original texts.

Kugel's purpose is to try to reconstruct the Bible as it was in its original form as closely as possible. While we all know that no copies of the original Bible exist today, the King James version was based on the Textus Receptus which was a Greek translation of the Bible and considered the oldest reliable source at the time. Since then there have been many archaeological finds of manuscripts from earlier points in time and in the original Hebrew language. Many of these passages differ somewhat from current translations. In theory, the older versions should be closer to the original version. Working from the oldest texts he examines some of the differences in the way passages were interpreted and what that could mean. This gets us closer to an original version without all the intervening thoughts and interpretations that earlier writers had added in an attempt to make it more understandable and applicable to the people of their time. Dr. Kugel thoroughly documents his work complete with quotes,

sources and annotations as appropriate. A fascinating book that sheds new light onto many passages it should be read by anyone attempting a serious and scholarly study of the Bible

King James Version Presentation Reference Bible: Black/Goatskin Leather

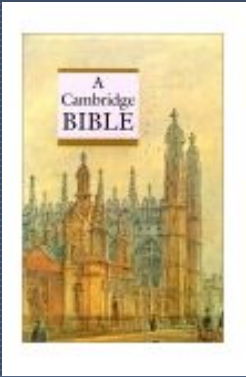

List Price: \$180.00

Price: \$180.00 & This item ships for **FREE** with Super Saver Shipping. [See details.](#) 

Availability: Usually ships within 24 hours

[see larger photo](#) [Used & new](#) from \$144.79

KJV Standard Reference Edition With Apocrypha (Black Calfskin Leather)



List Price: \$85.99

Price: \$85.99 & This item ships for **FREE** with Super Saver Shipping. [See details.](#) 

Availability: Usually ships within 24 hours

[Used & new](#) from \$62.69

[Look inside this book](#) **Edition:** Leather Bound

REB Text Edition with Apocrypha Black French Morocco leather REBA143

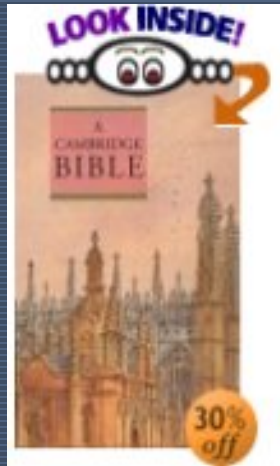

List Price: \$69.99

Price: **\$48.99** & This item ships for **FREE** with Super Saver Shipping.

[See details.](#) 

You Save: \$21.00 (30%)

Availability: Usually ships within 4 days

Used & new from \$44.00

[Look inside this book](#)



[back to the "Christian Links" page](#)





 <p>Great Cloud of Witnesses in Hebrews ... Ethelbert W. Bulli... New \$12.91! Used \$12.16!</p>	 <p>Great Cloud of Witnesses in Hebrews ... Ethelbert W. Bulli... New \$11.95! Used \$29.95!</p>	 <p>Word Studies on the Holy Spirit Ethelbert W. Bulli... New \$9.74! Used \$4.72!</p>
 <p>The Companion Bible Ethelbert W. Bulli... New \$52.28!</p>	 <p>The Companion Bible Ethelbert W. Bulli... New \$60.51!</p>	 <p>The Companion Bible Ethelbert W. Bulli... New \$37.39! Used \$27.99!</p>
 <p>King James Version Ethelbert W. Bulli... New \$56.06!</p>	 <p>The Witness of the Stars Ethelbert W. Bulli... New \$16.95!</p>	 <p>Commentary on Revelation E. W. Bullinger New \$19.79!</p>

(Prices May Change) [Privacy Information](#)

Each of these links will take you to the individual sections and back



| [Garden of Eden](#) | [Three World Ages](#) | [the Rebellion of Satan](#) | [What is the Mark of The Beast ?](#) |

| [Rapture of the Church Bible study](#) | [Rapture of the Church: the LIE that leads to the Beast](#) |

| [Christmas](#) | [Gentiles and the Jews](#) | [The Two Figs](#) |

the "Garden of Eden" Bible Study

The story of the garden of Eden is one that many know. One thing that might be missing from the story of the garden of Eden, is what really happened in Eden on that day. I was told as a child that it had something to do with apples. Well, when I read it when I became older I found out that the word apple is not even in the story. Apples have nothing what so ever to do with what happened in the garden of Eden. I am going to try the best I can with this Bible study to explain to you what really did happen in the garden of Eden. Without knowing what *really* happened in the garden of Eden, we miss out on so much information; information that we *need* to better understand God's word.

You may have never heard the story told like this before, and, it may come as a shock to you what really did happen in the Garden. We as God's children must not be shocked at the truth of God's word. What you will read will be graphic at times, but, in order to tell you what really did happen, it is necessary. We can never let God's Word be too graphic for us. If we do, then we are getting too self righteous for God, and He does not like that. One other thing that we need to know is that God uses symbology in His word, as we shall see very soon. I highly suggest having a Bible (I use the KJV translation) handy. Never simply "believe" a man at his own interpretation of the Bible - prove it through the Bible, itself. The best study Bible I have ever owned is [E.W. Bullinger's Companion Bible](#). To further corroborate the information, you may want to pick up a copy of ["The Bible the Way it Was" by James L. Kugel](#). Both are available from Amazon.com through these links. Here we go...

Genesis 3:1-20

V1 Now the serpent was more subtle than any beast of the field which the LORD God had made. And he said unto the woman, Yea, hath God said, Ye shall not eat of every tree of the garden?

Here we have our first clue, the word serpent. Now we all know that snakes do not talk. This is not some special talking serpent but a name for a person or being. The place to find out who this person is, is the book of Revelation.

Revelation 12:9 - V9 And the great dragon was cast out, that old serpent, called the Devil, and Satan, which deceiveth the whole world: he was cast out into the earth, and his angels were cast out with him.

So now we know who the serpent is, Satan. **Yes Satan was in the garden of Eden.** That can be found in Ezekiel 28:1-19 where it talks about Satan before and after his fall. We also see how Satan works by using lies and twisting God's word to suite his needs. We can read what God really said in Genesis 2:16-17

Genesis 2:16-17 - V16 And the LORD God commanded the man, saying, Of every tree of the garden thou mayest freely eat: V17 But of the tree of the knowledge of good and evil, thou shalt not eat of it: for in the day that thou eatest thereof thou shalt surely die.

Subtle means cunning (usually in a bad sense). Satan is very wise and cunning which is why we need God's help to make it in this world. Also keep in mind that God does not count days like we do.

II Peter 3:8 - V8 But, beloved, be not ignorant of this one thing, that one day is with the Lord as a thousand years, and a thousand years as one day.

V2 And the woman said unto the serpent, We may eat of the fruit of the trees of the garden:

V3 But of the fruit of the tree which is in the midst of the garden, God hath said, Ye shall not eat of it, neither shall ye touch it, lest ye die.

We are not talking about real trees here but it is symbolic of people. Lets take a quick look at Jeremiah.

Jeremiah 17:7-8 - V7 Blessed is the man that trusteth in the LORD, and whose hope the LORD is. V8 For he shall be as a tree planted by the waters, and that spreadeth out her roots by the river, and shall not see when heat cometh, but her leaf shall be green; and shall not be careful in the year of drought, neither shall cease from yielding fruit.

Tree means to fasten (or make firm), i.e. to close (the eyes). It also means the spine (as giving firmness to the body) backbone. So you see we are not really talking about a tree at all. **We are talking about a person, Satan.** He is the tree of the knowledge of good and evil. Satan invented evil as he was the first one to sin which can be read in Ezekiel 28:14-15

Ezekiel 28:14-15 - V14 Thou art the anointed cherub that covereth; and I have set thee so: thou wast upon the holy mountain of God; thou hast walked up and down in the midst of the stones of fire. V15 Thou wast perfect in thy ways from the day that thou wast created, till iniquity was found in thee.

Touch means to touch, i.e. lay the hand upon (for any purpose; euphemism., to lie with a woman). Adam and Eve were told not to touch the tree of the knowledge of good and evil in any way. As we found out that tree is really Satan we are talking about. **Keep in mind that touch means to lie with a woman.** That is a very important fact as we shall see very soon.

V4 And the serpent said unto the woman, Ye shall not surely die:

Here is Satan lying again. He knows good and well what God really said to Adam and Eve. They to knew what God said but they didn't listen. This is one of Satan's best tricks, taking the word of God and twisting it to suite his needs. As you probably already know that is how Satan tempted Jesus in the wilderness. Satan will use God's word but twist it just a little so it becomes untrue.

V5 For God doth know that in the day ye eat thereof, then your eyes shall be opened, and ye shall be as gods, knowing good and evil.

Up to this point Adam and Eve have not sinned, they did not know what evil was. But when they touch the tree of the knowledge of good and evil their eyes shall be opened and they shall know what evil is. At that point, they have sinned. Lets take a look Genesis 2:25 and we shall see that they are not ashamed to be naked because they did not sin yet.

Genesis 2:25 - V25 And they were both naked, the man and his wife, and were not ashamed.

V6 And when the woman saw that the tree was good for food, and that it was pleasant to the eyes, and a tree to be desired to make one wise, she took of the fruit thereof, and did eat, and gave also unto her husband with her; and he did eat.

Here we have the first sin of mankind. As you can see the word apple is nowhere in that verse, or any where in this whole chapter for that matter. The sin that was committed has absolutely nothing to do with eating apples. Now remember, the tree that is being talked about here is Satan. What Eve did was have intercourse with Satan. That's what the sin was and later we shall see that Cain's father is not Adam but Satan himself. This may be new to you and also may be a shock to hear. But remember that we must not let the truth in God's word shock us. That is really what happened, Eve had intercourse with Satan. Adam also took part, how and in what way I'm not sure. Seeing that Satan is supernatural, he could have appeared as a woman to Adam, maybe not. The point is that he did have a roll in what happened and did what God told him not to do.

V7 And the eyes of them both were opened, and they knew that they were naked; and they sewed fig leaves together, and made themselves aprons.

Remember in Genesis 2:25 they were both naked and not ashamed. Now they are because they have not listened to God and sinned. Other things to notice here are that they are in a fig grove, not being around apples. Also they took the fig leaves and made aprons to cover themselves. A apron does not go over your mouth but over your lower body. They covered the private parts because they were ashamed of the sin that was committed.

V8 And they heard the voice of the LORD God walking in the garden in the cool of the day: and Adam and his wife hid themselves from the presence of the LORD God amongst the trees of the garden.

V9 And the LORD God called unto Adam, and said unto him, Where art thou?

V10 And he said, I heard Thy voice in the garden, and I was afraid, because I was naked; and I hid myself.

Here we have them for the first time afraid to be close to God. They new what they did was wrong because God told them not to do it. Now they have sinned and don't want to be around God.

V11 And He said, Who told thee that thou wast naked? Hast thou eaten of the tree, whereof I commanded thee that thou shouldest not eat?

V12 And the man said, The woman whom thou gavest to be with me, she gave me of the tree, and I did eat.

Adam is trying to lay the blame on Eve but he knows good and well that God told him not to do it.

V13 And the LORD God said unto the woman, What is this that thou hast done? And the woman said, The serpent beguiled me, and I did eat.

As we have learned already the serpent is Satan. So is the tree of the knowledge of good and evil. Beguiled means to lead astray,

i.e. (mentally) to delude, or (morally) to seduce. Satan by twisting God's word with his lies and the power he has by being supernatural seduced Eve. Satan is very crafty and as we read in Revelation 12:9 he is the one that deceived the world.

V14 And the LORD God said unto the serpent, Because thou hast done this, thou art cursed above all cattle, and above every beast of the field; upon thy belly shalt thou go, and dust shalt thou eat all the days of thy life:

This is God's way of letting Satan know He thinks he is the lowest form of life ever created.

V15 And I will put enmity between thee and the woman, and between thy seed and her seed; it shall bruise thy head, and thou shalt bruise his heel.

God is still talking to Satan here. Enmity means to hate (as one of an opposite tribe or party); hence to be hostile. Seed means seed; figuratively, fruit, plant, sowing-time, posterity. This tells us that there will be hostility between Satan's children and Eve's children. Satan's child will grow up and become the first murderer. Satan's offspring in time will bruise Jesus Christ's heel when they nail Him to the cross. Eve will have two children, Cain and Abel but they do not both have the same father. **Adam is Abel's father while Satan is Cain's father. Later when we take a look at Adam's genealogy we shall find that Cain is not mentioned. That's because Adam is not Cain's father, Satan is.**

V16 Unto the woman He said, I will greatly multiply thy sorrow and thy conception; in sorrow thou shalt bring forth children; and thy desire shall be to thy husband, and he shall rule over thee.

God's sentence to Eve was that her sorrow in child birth would be greatly multiplied. God did not give her a tummy ache for eating to many apples. God gave her more pain in having children for having committed the sin of having intercourse with Satan.

V17 And unto Adam He said, Because thou hast hearkened unto the voice of thy wife, and hast eaten of the tree, of which I commanded thee, saying, Thou shalt not eat of it: cursed is the ground for thy sake; in sorrow shalt thou eat of it all the days of thy life;

V18 Thorns also and thistles shall it bring forth to thee; and thou shalt eat the herb of the field;

V19 In the sweat of thy face shalt thou eat bread, till thou return unto the ground; for out of it wast thou taken: for dust thou art, and unto dust shalt thou return.

Adam did the wrong thing by obeying what his wife wanted to do and not obeying what God wanted him to do. God should always come first in our life's.

V20 And Adam called his wife's name Eve; because she was the mother of all living.

Eve is the mother of all living because it is through her offspring that Jesus Christ will be born. It does not mean we are all descendants of Eve but through Christ we can have eternal life. Lets continue are study in chapter 4.

Genesis 4:1-26

V1 And Adam knew Eve his wife; and she conceived, and bare Cain, and said, I have gotten a man from the LORD.

V2 And she again bare his brother Abel. And Abel was a keeper of sheep, but Cain was a tiller of the ground.

Again means to add or augment (often adverbial, to continue to do a thing). Eve continued in labor and gave birth to Abel. Cain and Abel are fraternal twins, which means they came from two separate bags of water. They had separate conceptions. It is possible for fraternal twins to have different fathers, just like Cain and Abel did.

V3 And in process of time it came to pass, that Cain brought of the fruit of the ground an offering unto the LORD.

V4 And Abel, he also brought of the firstlings of his flock and of the fat thereof. And the LORD had respect unto Abel and to his offering:

V5 But unto Cain and to his offering he had not respect. And Cain was very wroth, and his countenance fell.

Wroth means to glow or grow warm; figuratively (usually) to blaze up, of anger, zeal, jealousy. God had respect for Abel's offering because he offered the best parts of the first of his flock to the Lord. Cain on the other hand did not offer the best or the first of what he had to the Lord. Cain did not love God enough to offer Him the best of what he had.

V6 And the LORD said unto Cain, Why art thou wroth? and why is thy countenance fallen?

V7 If thou doest well, shalt thou not be accepted? and if thou doest not well, sin lieth at the door. And unto thee shall be his desire, and thou shalt rule over him.

Cain fell short, he missed the mark by not offering the best he had to the Lord.

V8 And Cain talked with Abel his brother: and it came to pass, when they were in the field, that Cain rose up against Abel his brother, and slew him.

Cain becomes the first *murderer*.

V9 And the LORD said unto Cain, Where is Abel thy brother? And he said, I know not: Am I my brother's keeper?

Now Cain is lying to God. Family members are to take care and look out for each other, not kill each other. Let's take a look at I John. Also notice in V12 it says Cain is from "that wicked one" meaning Satan was his father.

I John 3:10-12 - V10 In this the children of God are manifest, and the children of the devil: whosoever doeth not righteousness is not of God, neither he that loveth not his brother. V11 For this is the message that ye heard from the beginning, that we should love one another. V12 Not as Cain, who was of that wicked one, and slew his brother. And wherefore slew he him? Because his own works were evil, and his brother's righteous.

V10 And He said, What hast thou done? the voice of thy brother's blood crieth unto Me from the ground.

V11 And now art thou cursed from the earth, which hath opened her mouth to receive thy brother's blood from thy hand;

V12 When thou tillest the ground, it shall not henceforth yield unto thee her strength; a fugitive and a vagabond shalt thou be in the earth.

Cain's sentence for murdering his brother is handed down by God.

V13 And Cain said unto the LORD, My punishment is greater than I can bear.

V14 Behold, Thou hast driven me out this day from the face of the earth; and from Thy face shall I be hid; and I shall be a fugitive and a vagabond in the earth; and it shall come to pass, that every one that findeth me shall slay me.

Here is Cain caring about his own life but he didn't care to much about his brothers.

V15 And the LORD said unto him, Therefore whosoever slayeth Cain, vengeance shall be taken on him sevenfold. And the LORD set a mark upon Cain, lest any finding him should kill him.

Notice that God set a mark on Cain, that mark is very important, it is the beginning of the mark of the beast. It is also a spiritual mark. Cain's offspring in the Bible are called Kenites. Lets take a look at John 8:42-47 where Jesus is talking to some Kenites.

John 8:42-47 - V42 Jesus said unto them, If God were your Father, ye would love Me: for I proceeded forth and came from God; neither came I of Myself, but He sent Me. V43 Why do ye not understand My speech? even because ye cannot hear My word. V44 Ye are of your father the devil, and the lusts of your father ye will do. He was a murderer from the beginning, and abode not in the truth, because there is no truth in him. When he speaketh a lie, he speaketh of his own: for he is a liar, and the father of it. V45

And because I tell you the truth, ye believe Me not. V46 Which of you convinceth Me of sin? And if I say the truth, why do ye not believe Me? V47 He that is of God heareth God's words: ye therefore hear them not, because ye are not of God.

Kenites claim to be Jews but they are not as we shall read in Revelation.

Revelation 2:8-11 - V8 And unto the angel of the church in Smyrna write; These things saith the First and the Last, Which was dead, and is alive; V9 I know thy works, and tribulation, and poverty, (but thou art rich) and I know the blasphemy of them which say they are Jews, and are not, but are the synagogue of Satan. V10 Fear none of those things which thou shalt suffer: behold, the devil shall cast some of you into prison, that ye may be tried; and ye shall have tribulation ten days: be thou faithful unto death, and I will give thee a crown of life. V11 He that hath an ear, let him hear what the Spirit saith unto the churches; He that overcometh shall not be hurt of the second death.

You can also read about the Kenites who claim to be Jews in Revelation 3:7-13 where it is talking about the church of Philadelphia. Out of the seven churches talked about in Revelation, Jesus only found the church of Smyrna and Philadelphia without any faults. One of the reasons being is that they know the truth about the Kenites, the sons of Cain. ***If your not in a church that teaches you about the Kenites or what really happened in the garden, it's time to find one that does. After all, why would you want to belong to a church system that Jesus finds faults with?***

V16 And Cain went out from the presence of the LORD, and dwelt in the land of Nod, on the east of Eden.

Lets skip down to verse 25.

V25 And Adam knew his wife again; and she bare a son, and called his name Seth: For God, said she, hath appointed me another seed instead of Abel, whom Cain slew.

V26 And to Seth, to him also there was born a son; and he called his name Enos: then began men to call upon the name of the LORD.

Here we read that Adam and Eve had another son, Seth. This way the generations leading up to the birth of Jesus stay pure. In Genesis 5 we have the generations of Adam all the way to Noah and his sons. We are just going to look at a bit of it and you will see that ***Cain is not mentioned as a child of Adam.***

Genesis 5:1-14

V1 This is the book of the generations of Adam. In the day that God created man, in the likeness of God made He him;

V2 Male and female created He them; and blessed them, and called their name Adam, in the day when they were created.

V3 And Adam lived an hundred and thirty years, and begat a son in his own likeness, after his image; and called his name Seth:

V4 And the days of Adam after he had begotten Seth were eight hundred years: and he begat sons and daughters:

V5 And all the days that Adam lived were nine hundred and thirty years: and he died.

V6 And Seth lived an hundred and five years, and begat Enos:

V7 And Seth lived after he begat Enos eight hundred and seven years, and begat sons and daughters:

V8 And all the days of Seth were nine hundred and twelve years: and he died.

V9 And Enos lived ninety years, and begat Cainan:

V10 And Enos lived after he begat Cainan eight hundred and fifteen years, and begat sons and daughters:

V11 And all the days of Enos were nine hundred and five years: and he died.

V12 And Cainan lived seventy years, and begat Mahalaleel:

V13 And Cainan lived after he begat Mahalaleel eight hundred and forty years, and begat sons and daughters:

V14 And all the days of Cainan were nine hundred and ten years: and he died.

As you read Cain is nowhere to be found in the seed line of Adam. Satan is Cain's father and through Cain and his offspring Satan has children on earth this very day.

I hope that you found this study helpful and that it gives you a better understanding of what really did happen in the garden of Eden. The fact the Adam is not Cain's father but that Satan is his father. That is information that we need to know in order to better understand the word of God. The fact that Satan has children on this earth today is one reason why there is so much evil going on in this world. We also have the beginning of the mark of the beast with Cain being marked by God. To learn more about this mark and the beast, take a look at our study on the mark of the beast.

[back to index](#)

The Two Fig Trees

Dualism of Genesis 3, Genesis 6, Jeremiah 24, Matthew 13, and John 8

These scriptures detail something that very few people realize today. There is a mystery in the Bible that most people cannot even see, and that mystery goes back to the beginning of The Bible. It is a Foundational Truth which so few ever recognize or understand. The Bible constantly speaks in Agrarian terminology; that is, of a Gardener or a Farmer. It speaks of Planting Seeds, Fig Trees, Vines, and Pruning. This is because these terms detail EXACTLY what this process that we call life is about! Our Heavenly Father planted us, just as we would plant a seed in the ground. He is the ULTIMATE GARDENER. What is he cultivating? His Children ! He is, through this process, weeding out those who will not follow him, of their own free volition. In this manner, he finds out who truly loves him, no matter what ! Those who willingly follow him and love him, will one day become his literal adopted children. I want to point out that in several places, what you will see here will conflict with what you have been told about the Bible, but not with The Bible Itself. I suggest that you keep a Bible handy, or better yet, print this out, and use it in your next Bible study. I would also suggest that you purchase a Strong's Exhaustive Concordance, and a Bullinger's Companion Bible. I also suggest you read over "the Garden Of Eden" Bible study (above) before continuing. **All Scripture is taken from The King James Translation.**

MATTHEW 13 The Parable of The Wheat and The Tares

MAT 13: 24 Another Parable He put Forth unto them, saying" The Kingdom of Heaven is likened unto a man, which sowed good seed in his field.

25 But while men slept, his enemy came and sowed tares among the Wheat, and went his way.

26 But when the blade was sprung up, and brought forth fruit, then appeared tares also.

27 So the servants of the householder came and said unto Him, Sir, Didst not thou sow good seed in thy field? from whence then

hath it tares?

28 He said unto them, an enemy hath done this. The servants said unto him, Wilt thou then that we go and gather them up?

29 But He said, NAY; lest while Ye gather up the tares, Ye root up also The wheat with them.

30 Let Both grow together until The Harvest: And in the time of Harvest I will say to The Reapers, Gather Ye Together first the tares, and bind them in Bundles to burn them: but gather The wheat into my Barn.

MATTHEW 13:36-43 The Parable of The Wheat and The Tares is Explained.

MAT 13: 36 Then Jesus sent The multitude away, and went into the house: and his disciples came unto him, saying, Declare unto us The Parable of The Tares of the field.

37 He answered and said unto them, He that Soweth The GOOD SEED is The SON OF MAN;

38 The field is the world; The GOOD SEED are The CHILDREN OF THE KINGDOM; But the TARES are The CHILDREN OF THE WICKED ONE;

39 The ENEMY that Sowed Them is THE DEVIL; The harvest is the end of the world; and the reapers are the angels.

40 As therefore the TARES are gathered and burned in the fire; so shall it be in the end of This world.

41 The Son of Man shall send forth his angels and they shall gather out of his kingdom all things that offend, and them which do iniquity;

42 And shall cast them into a furnace of fire: there shall be wailing and Gnashing of Teeth.

43 Then shall the righteous shine forth as the sun in the kingdom of their Father. Who hath ears to hear, let him hear.

- 1.) Jesus sowed the Good Seed (The Wheat).
- 2.) The Good Seed are the people that GOD Created in The Beginning.
- 3.) Notice that the Field is THE WORLD, not The Church, as it is erroneously taught.
- 4.) Satan, Lucifer, The Serpent, The Dragon, then sowed BAD Seed. (The Tares)
- 5.) The BAD SEED are SATAN'S "CHILDREN."

I want to state here, that many preachers will claim that, " Well, Jesus really meant...". To be Honest, Jesus SAID what He meant. After all, He IS God. Don't think for a minute that Jesus couldn't speak for Himself, and he surely doesn't need YOU or I to speak for Him. We do not have the Power or Authority to view these Scriptures in any other light. They were kept as God WANTED them kept.

JOHN 8 Jesus Reveals Who Satan's Children are.

- JOHN 8: 31 Then said Jesus to those Jews which believed on him, If ye continue in my word, then are ye my disciples indeed
- 32 And ye shall know the truth, and the truth shall make you free
- 33 They answered Him , We be Abraham's seed, and were NEVER in bondage to any man; how sayest thou, Ye shall be made free?
- 34 Jesus answered them, Verily, Verily, I say unto you, whosoever committeth sin is the servant of sin
- 35 And the servant abideth not in the house forever; but the Son abideth forever
- 36 If the Son therefore shall make you free, ye shall be free indeed
- 37 I know that ye are Abraham's seed; but ye seek to kill me, because my word hath no place in you.
- 38 I speak that which I have seen with MY FATHER; and YOU do that which ye have seen with YOUR father.
- 39 They Answered and said unto him. Abraham is Our father, Jesus said unto them, IF Ye WERE Abraham's Children, Ye WOULD DO the works of Abraham.
- 40 But now ye seek to kill me, a man that hath told you the truth, which I have heard of GOD: this did not Abraham do.
- 41 Ye do The Deeds of YOUR father. Then said they unto Him, We Be NOT Born of FORNICATION; we have one father, even God.
- 42 Jesus said unto them," IF God were your Father, ye would love me: for I proceed forth and came from God; neither came I of myself, but he sent me.
- 43 WHY do Ye NOT Understand my Speech? even BECAUSE YE CAN NOT HEAR MY WORD.
- 44 Ye are of Your father THE DEVIL, and the lusts of your father ye WILL DO. He was a murderer from the Beginning, and abode NOT in The Truth, because there IS NO TRUTH IN HIM. When He Speaketh a LIE, he speaketh of his own: for He is a Liar, and The father of it.
- 45 And because I tell you the truth, ye believe me not.
- 46 Which of you convinceth me of sin? And if I say the truth, why do Ye not believe me?
- 47 He that IS OF GOD HEARETH GOD'S WORD: Ye Therefore Hear them NOT, because ye ARE NOT OF GOD.

In Chapter 8 of The Book of John, Jesus is talking to The Pharisees, who are some of the Jewish Civil and Religious Leaders of that day.

Please note that these men believed that he was a messenger of God, but they did not believe THE GOSPEL OF THE KINGDOM OF GOD!!

Notice John 8:31 states that Many Jews believed ON Him, yet when Jesus addresses them, He states that they are Children of the Devil, and that is the reason that they did not BELIEVE HIM.

I personally have known MANY men and women who Believed that Jesus is The Messiah, yet they Vehemently deny THE GOSPEL; even to the point of becoming violently angry when confronted on this issue.

GENESIS 3 The Serpent Lucifer Beguiles Eve in The Garden of God.

GEN 3: 1 Now the SERPENT was more subtle than any beast of the field which The LORD God had made. And he said unto the Woman, Yea, hath God said, Ye shall not eat of every tree of the garden?

2 And the woman said unto the serpent, We may eat of the fruit of the trees of the garden:

3 But of the fruit of the tree which is in the midst of the garden, God hath said, Ye shall not eat of it, neither shall ye touch it, lest ye die.

4 And the serpent said unto the woman, Ye shall not surely die:

5 For God doth know that in the day Ye eat thereof, then your eyes shall be opened , and ye shall be as gods, knowing good and evil.

6 And when the woman saw that the tree was good for food, and that it was pleasant to the eyes, and a tree to be desired to make one wise, she took of the fruit, and did eat, and gave also unto her husband with her; and He did eat.

7 And the eyes of them both were opened, and they knew that they were naked; and they sewed fig leaves together, and made themselves aprons.

8 And they heard the voice of the LORD God walking in the garden in the cool of the day: and Adam and his wife hid themselves from the presence of the LORD God amongst the trees of the garden.

9 And the LORD God called unto Adam, and said unto him, Where art thou?

10 And he said, I heard thy voice in the garden, and I was afraid, because I was naked; and I hid myself.

11 And he said, Who told thee that thou wast naked? Hast thou eaten of the Tree, whereof I commanded thee that thou shouldest not eat?

12 And the man said, The Woman thou gavest to be with me, she gave me of The Tree, and I did Eat.

13 And the LORD God said unto the woman, What is this that thou hast done? And the woman said, The serpent BEGUILLED me, and I did eat.

14 And the LORD God said unto the serpent, Because thou hast done this, thou art cursed above all cattle, and above every beast of the field; upon thy belly shalt thou go, and dust shalt thou eat all the days of thy life:

15 And I will put ENMITY between thee and the woman, and between THY SEED and HER SEED : it shall bruise thy head, and thou shalt bruise his heel.

16 Unto the woman he said, I will greatly Multiply THY SORROW AND CONCEPTION: in sorrow shalt thou bring forth Children; and thy desire SHALL BE to thy Husband, and He shall rule over thee.

17 And unto Adam he said, because thou has harkened unto the voice of thy wife, and has eaten of the tree, of which I commanded thee, saying, Thou Shalt Not eat of it: CURSED is The Ground for thy sake; in sorrow shalt thou eat of it all the days of thy life.

18 Thorns also and thistles shall it bring forth to thee; and thou shalt eat the Herb of the field;

19 In the sweat of thy face shalt thou eat bread, till thou return unto the ground; for out of it was thou taken: for dust thou art, and unto dust shalt thou return.

20 And Adam called his Wife's name Eve; because she was the mother of all living.

21 Unto Adam also unto his wife did the LORD God make coats of skin, and clothed them.

22 And the LORD God said, Behold, the man is become as one of us, to know good and evil: and now, lest he put forth his hand, and take also of the tree of life, and eat, and live forever:

23 Therefore the LORD God sent him forth from the garden of Eden, to till the ground from whence he was taken.

24 So he drove out the man; and placed at the east of the Garden Cherubim's, and a flaming Sword which turned every way, to keep the way of the tree of life.

The Hebrew Keywords to Genesis 3 are as Follows:

Enmity: # 342 eybah: Ay-Baw; from # 340 Ayab; mortal:-enmity, hatred. # 340 ayab: aw-yab'; a prim. root; to hate (as one of an opposite tribe or party); hence to be hostile:-be an enemy.

Fruit: # 6529 periy: Per-ee'; from #6509fruit (lit. or fig.):-bough, ([first-]) fruit, ([-ful]), reward. # 6509 parah: paw-raw'; a prim. root; to bear fruit(lit. or fig.):- bear, bring fruit (fruit), (be, cause to be, make) fruitful, grow, increase.

Seed: # 2233 zera: Zeh-Rah; from # 2232; seed; fig. fruit, plant, sowing time, posterity:- X carnally, child, fruitful, seed (-time), sowing time. # 2232 zara: Zaw-Rah; to sow; fig. to disseminate, plant, fructify;- bear, conceive seed, set with, sow (-er), yield.

Serpent: # 5175 nachash: naw-khawsh; from #5172; a snake (from it's hiss);a serpent. # 5172 nachash: naw-khash; a prim. root; prop. to hiss, i.e. whisper a (magic) spell; gen. to prognosticate;- X certainly, divine, enchanter, (use) X enchantment, learn by experience, X indeed, diligently observe.

Touch: # 5060 naga: Naw-Gah;a prim. root-prop. to touch; i.e. lay the hand upon(for any purpose; euphemism to lie with a woman); by impl. to reach (fig. to arrive, acquire); violently, to strike, bring (down), cast, come (nigh), draw near (nigh), get up, happen, join, near, plague, reach (up), smite, strike, touch.

Tree: # 6086 ets: ates; from # 6095; a tree (from it's firmness); hence wood (plur. sticks):- +carpenter, gallows, helve, +pine, plank, staff,stalk, stick,stock, timber, tree, wood. # 6095 atsah: aw-tsaw'; a prim. root; prop. to fasten (or make firm), i.e. to close (the eyes):-shut. # 6096 atseh: aw-tseh'; from # 6095; the spine (as giving firmness to the body):-backbone.

Woman: # 802 ishshah: ish-shaw`; fem. of # 376 or # 582; irregular plur. nashiym: naw-sheem'; a woman (used in the same wide sense as # 582):-[adulter]ess, each, every, female, X many + none, one, +together, wife, woman. Often unexpressed in English. # 582 enowsh: en-oshe'; from # 605; prop. a mortal (and thus differing from the more dignified # 120); hence a man in gen. (singly or collect.):-another, X [blood] thirsty, certain, chap [-man], diverse, fellow, X in the flower of their age, husband, (certain mortal) man, people, person, servant, some (X of them), + stranger, those, + their trade. it is often unexpressed in the English Version, especially when used in apposition with another word. Comp. 376.

So, this Serpent was a person, and not a snake. A certain someone who revealed a divine secret to Eve in a whispering manner! I wonder who that certain someone was? I wonder what that secret was? Note this Proverb

Proverbs 30:20 Such is the way of an Adulterous Woman; she eateth, and wipeth her mouth, and saith, I have done no wickedness.

What Did Eve do? Did she make a rag to wash her face, or a mask to cover her mouth? NO !! She made an apron to cover her sin! "Well, Adam made an apron too!", You Say. Yes, Adam did make an Apron, because He was just as Guilty as Eve! When Eve ate of The Fruit, She was no longer in a state of Perfection; while Adam was still in perfection. Notice that the serpent told Eve that the fruit would make her wise, and her eyes would be opened in GEN. 3:5. Adam, knowingly and willingly, stepped down from his state of sinless perfection, to join his wife; because he loved her, and wanted to be with her. When he was caught, he tried to pass the blame on to Eve; and She in turn passed it over to The Serpent, who made no attempt to deny it!

Jeremiah 24 The Two Baskets of Figs.

JER 24: 1 The LORD shewed me, and behold, two baskets of figs were set before the temple of The LORD, after that Nebuchadrezzar, king of Babylon had carried away captive Jeconiah the son of Jehoiakim king of Judah, and the princes of Judah, with the carpenters and smiths, from Jerusalem, and had brought them to Babylon.

2 One basket had very good figs, even like the figs that are first ripe: and the other had very naughty figs, which could not be eat, they were so bad.

3 Then said The LORD unto me, What seest thou, Jeremiah? And I said, Figs; the good figs, very good, and the evil, very evil, that can not be eaten, they are so evil.

4 Again the word of The LORD came unto me saying,

5 Thus Saith The LORD, The God of Israel; Like these good figs, so will I acknowledge them that are carried away captive of Judah, whom I have sent out of this place into the land of The Chaldeans for their own good.

6 For I will set mine eyes upon them for good, and I will bring them again to this land: and I will build them up, and not pull them down; and I will plant them, and not pluck them.

7 And I will give them an Heart to know me, that I am The LORD: and they shall be my people, and I will be their God; for they shall return unto me with their whole heart.

8 And as the evil figs, which cannot be eaten, they are so evil; surely, thus saith The LORD, so will I give Zedekiah the king of Judah, and his princes, and the residue of Jerusalem, that remain in this land, and them that dwell in the land of Egypt.

9 And I will deliver them to be removed into all the kingdoms of the earth, for their hurt, to be a reproach, and a proverb, a taunt and a curse, in all places whither I shall drive them;

10 And I will send the sword, the famine, and the pestilence, among them, till they be consumed from off the land that I gave unto them and their fathers.

Notice Jeremiah 24:2. There are Good Figs, and Bad Figs.

Both are set before the Temple of The LORD. In Jerusalem today, there are two FIG TREES that were planted on MAY 14, 1948. There are both Good Figs, and Bad Figs planted in the land of Palestine.

Who are the Good Figs?

The Good Figs are descendants of the House of Judah, that is, they are bloodline descendants from one of the 12 Tribes of Israel- The Tribe of Judah.

Who are the Bad Figs?

Among the people that we call Jews today, are a people who are NOT JUDEANS at all. We are Warned about "...those who SAY that they are Jews, and are not.." in Revelation 2:9 and 3:9.

Well, if they are not Judeans, then WHO are these Imposters?

They are the product of the ORIGINAL SIN! Let that sink in for a minute!

Cain and His Children.

Cain # 7014 # 7014 qayin: kah'-yin; the same as # 7013 (with a play upon the affinity to #7069); Kajin, the name of the first child, also of a place in Pal., and of an Oriental Tribe:-Cain, Kenite(-s). # 7013 qayin: kah'-yin; from # 6969 in the orig. sense of fixity; a lance (as striking fast):-spear. # 7069 qanah: kaw-nah'; a prim. root; to erect, i.e. create; by extens. to procure, espec. by purchase (caus. sell); by impl. to own:-attain, buy (-er), teach to keep cattle, get, provoke to jealousy, possess (-or), purchase, recover, redeem, X surely, X verily. # 6969 quwn: koon; a prim. root; to strike a musical note, i.e. chant or wail (at a funeral):-lament, mourning woman.

Kenites # 7017 - # 7017 Qeyniy: kay-nee' or # 7017 Qiyiny: (1st. Chron. 2:55)kiy-nee'; patron. from # 7014; a Kenite or member of the tribe of Kajin:-Kenite.

These people are called KENITES. They had already attached themselves to the Tribe of Judah, when The Record of The Tribe was listed in 1st. Chronicles 2:55; there, it states that they are Scribes-but it does NOT say that they are Judaens. The Kenites are Cain's Children. The very name Kenite means a Child of Cain.

Look at Genesis 3.

Do you see where Eve ate The Apple? Well, Please show it to me, because I have been looking for it for the last 10 years. Which verse is it? I want to know, especially since the term **Apple** does not appear in the Entire book of Genesis! You see, because you have been constantly told that a TALKING SNAKE tricked Eve into EATING AN APPLE; and, She then gave a piece of Apple to Adam, you have accepted it as a Biblical Fact when it is nothing but a tradition!

This is a LIE!

This was a Lie that Adults told Children, to evade The Sex Question, as far as I am concerned. Throughout the "Dark Ages", this myth gained acceptance as if it were fact. This is a myth that has been passed down since the Dawn of time. Upon a careful research of Genesis 3 in it's Original Languages of Hebrew and Chaldean; you will quickly understand what these Symbols are for.

Eve was Seduced, both Physically **and** Mentally.

The "Serpent" was not a Snake! It was **Satan**, in the guise of an Angel of Light.

Lucifer mated with Eve, producing a type of being that should have Never been created; a hybrid of Man and Angel.

This act created Cain, who was Half Fallen Angel/Half Human!

Satan did this, in an attempt to TAIN'T Eve's Womb; so that Jesus Christ could not have been born!

There is a false Premise which abounds throughout The World of Christianity; that False Premise is this: Lucifer and The Angels couldn't possibly have brought forth Children.

Genesis 6:1-4 destroys this teaching completely!

Let's look and see what Genesis 6 has to say concerning whether Angelic Beings can reproduce.

Genesis 6 reveals that Angels did mate with the daughters of Adam!

GEN 6: 1 And it came to pass, when men began to multiply on the face of the earth, and daughters were born unto them,

2 That the sons of God saw the daughters of men that they were fair; **and they took them wives of all which they chose.**

3 And he said, My spirit shall not always strive with man, for that he also is flesh: yet his days shall be an hundred and twenty years.

4 There were giants in the earth in those days; and also after that, when the **sons of God**(the fallen angels) came in unto the daughters of men, **and they bare children to them**, the same became mighty men which were of old, men of renown.

The term Sons of God is a reference to The Angels; in fact, The Septuagint translates these verses as Angels. They are sons of God because they were directly created by God. Adam is also called a son of God, and Christians are also referred to as sons of God. The Giants were the children that were produced when the sons of God came unto The Daughters of Men (ha'adam' GEN. 2:7).

Biblical use of the term sons of God.

JOB 1:6 Now there was a day when the sons of God came to present themselves before the LORD, and Satan came also among them.

JOB 2:1 AGAIN there was a day when the sons of God came to present themselves before the LORD, and Satan came also among them to present himself before the LORD.

JOB 38:7 When the morning stars sang together, and all of the sons of God shouted for glory.

In these 3 verses **Angels** are translated as **sons of God**, and in Psalm 89:6 **Angels** has been translated **sons of the Mighty**. We do not have the Authority to translate these scriptures to simply mean Men or Mankind. There have been numerous attempts by men down through the ages to say that these sons of God were simply humans, but that is not what Our Father's Word says. Now **YOU** have a choice to make: Which will you accept as The Truth? The letter written to you by The LORD God Almighty or the Traditions of Men which are constantly taught as Christianity? **The very Traditions of Men which the Christ spoke against in MARK 7:9, when He said, " ..Full Well ye reject the commandment of God, that ye may keep your own tradition."**

[back to index](#)

Three World Ages

Did you know that there was an earth age before this one? That the earth is really millions of years old? There was a time that we all lived on this earth in our spiritual bodies and everyone was happy. To find out what brought that to an end, read our study on the Rebellion of Satan. These two studies go hand in hand to explain why we are here and what brought the first earth age to an end. I'm not talking about reincarnation as we go through this earth age one time only. In this study we are going to take a look at the first earth age and how God destroyed it.

Genesis 1:1-2

V1 In the beginning God created the heaven and the earth.

The word 'beginning' is Strong's number 7225 and means re'shiyth (ray-sheeth'); from the same as 7218; the first, in place, time, order or rank (specifically, a firstfruit). The word 'created' is Strong's 1254 and means bara' (baw-raw'); a primitive root; (absolutely) to create; (qualified) to cut down (a wood), select, feed (as formative processes): -choose, create (creator), cut down, dispatch, do, make (fat). God does not give us a year when He did this, just that He did it "In the beginning". The earth is not 7000 years old as some Christians claim but many millions of years old. It is only the earth age we live in now, the second, that is about 7000 years old. The dinosaur bones and fossils that are found date back more than 7000 years and are from the first earth age.

V2 And the earth was without form, and void; and darkness was upon the face of the deep. And the Spirit of God moved upon the face of the waters.

The word 'was' is Strong's number 1961 and means hayah (haw-yaw); a primitive root [compare 1933]; to exist, i.e. be or become, come to pass (always emphatic, and not a mere copula or auxiliary). The words 'without form' is Strong's 8414 and means tohuw (to'-hoo); from an unused root meaning to lie waste; a desolation (of surface), i.e. desert; figuratively, a worthless thing; adverbially, in vain. The word 'void' is Strong's 922 and means bohuw (bo'-hoo); from an unused root (meaning to be empty); a vacuity, i.e. (superficially) an undistinguishable ruin. God did not create the earth without form and void but it *became* that way. God destroyed the first earth age because of the Rebellion of Satan.

Isaiah 45:18

V18 For thus saith the LORD that created the heavens; God Himself That formed the earth and made it; He hath established it, He created it not in vain, He formed it to be inhabited: I am the LORD; and there is none else.

The word 'vain' is the same word that 'without form' is in Genesis 1:2 Strong's 8414. God created the earth to be inhabited but Satan's rebellion caused God to destroy that earth age. That was the first earth age and we now are living in the second earth age. The first earth age as well as the third earth age are spiritual ages meaning we just have our spiritual bodies. It is only in this second earth age that we have flesh and spiritual bodies. Just so you know, I'm not talking about reincarnation. We live in this second earth age one time and one time only. Some people may claim to have lived on earth hundreds or even thousands of years ago but they are possessed by evil spirits. That was going on a lot when Christ was on the earth and I feel it will be happening more and more until Christ returns again.

Now lets go to II Peter and read how God destroyed the first earth age.

II Peter 3:1-8

V1 This second epistle, beloved, I now write unto you; in both which I stir up your pure minds by way of remembrance:

V2 That ye may be mindful of the words which were spoken before by the holy prophets, and of the commandment of us the apostles of the Lord and Saviour:

Peter wants to remind us of the things that were spoken about by others in the Bible.

V3 Knowing this first, that there shall come in the last days scoffers, walking after their own lusts,

V4 And saying, Where is the promise of His coming? for since the fathers fell asleep, all things continue as they were from the beginning of the creation.

The word "scoffers" is Strong's 1703 and means empaiktes (emp-aheek-tace'); from 1702; a derider, i.e. (by implication) a false teacher. The word "lusts" is Strong's 1939 and means epithumia (ep-ee-thoo-mee'-ah); from 1937; a longing (especially for what is forbidden). There are many false teachers walking after their own lusts today. They teach the lusts of their own mind and not the true word of God. They teach such lies like Christ will rapture them away before the great tribulation or that the mark of the beast is a chip or tattoo. We also have people that say Christ will never return at all. Then there are groups of people that set a date for Christ to return and when it don't happen they get all bummed out and kill themselves. That just adds fuel for the people that say He is never coming back anyway. Be smart and do what Christ said. Watch and wait. Don't set dates because the only one that knows the date is God. Just get yourself ready for that day by reading God's word so you will not be caught off guard and deceived

by Satan.

V5 For this they willingly are ignorant of, that by the word of God the heavens were of old, and the earth standing out of the water and in the water:

V6 Whereby the world that then was, being overflowed with water, perished:

The word "perished" is Strong's 622 and means *apollumi* (ap-ol'-loo-mee); from 575 and the base of 3639; to destroy fully (reflexively, to perish, or lose), literally or figuratively. Some people desire to be ignorant to the fact that the earth is more than seven thousand years old when there is scientific proof which God's word aligns with. The dinosaur bones that are found today are from the first earth age when dinosaurs walked the earth. Satan likes to play a lot of tricks but this is not one of them. Dinosaurs are talked about in God's word by God Himself in the book of Job. Read Job 40:15-24 and all of chapter 41 We were on the earth in our spiritual bodies in the first earth age with the dinosaurs. Because of the rebellion of Satan God destroyed fully that earth age with a flood. This is not talking about Noah's flood which happened in this earth age because it was not destroyed fully.

I Peter 3:20

V20 Which sometime were disobedient, when once the longsuffering of God waited in the days of Noah, while the ark was a preparing, wherein few, that is, eight souls were saved by water.

V7 But the heavens and the earth, which are now, by the same word are kept in store, reserved unto fire against the day of judgment and perdition of ungodly men.

This is talking about the earth age we live in now and looking forward to the Lord's day.

V8 But, beloved, be not ignorant of this one thing, that one day is with the Lord as a thousand years, and a thousand years as one day.

God does not count time like we do. It takes a thousand of our years to make one day for God. In the story of creation, God took six days to do it and then rested on the seventh. So, six days for God would be six thousand years for us. The seventh day would be another thousand years to make seven thousand years total. The earth age we live in now is almost seven thousand years old. Am I saying Christ will return soon? No. I'm not setting a date and you shouldn't either. This is just some food for thought that we all should be getting ready for the day that Christ does return. Lets go to one more place where it talks about the flood of the first earth age.

Psalms 104:5-9

V5 Who laid the foundations of the earth, that it should not be removed for ever.

As we read in Isaiah 45:18 God created this earth to be inhabited. We all walked this earth in the first earth age when we were in our spiritual bodies. We walk on it now in our flesh bodies and those that go to heaven will be on this earth in their spiritual bodies once again. This earth will never go away and heaven will be on this earth after the great white throne judgment of God.

V6 Thou coveredst it with the deep as with a garment: the waters stood above the mountains.

V7 At Thy rebuke they fled; at the voice of Thy thunder they hasted away.

The word "hasted" is Strong's 2648 and means *chaphaz* (khaw-faz'); a primitive root; properly, to start up suddenly, i.e. (by implication) to hasten away, to fear. We know that this is talking about the flood of the first earth age and not Noah's because in Noah's flood the waters did not hast away. In Genesis chapter 8 we read it took the water in Noah's flood months to dry up. In the first flood, God wanted the earth dry and it was dry, instantly.

V8 They go up by the mountains; they go down by the valleys unto the place which Thou hast founded for them.

V9 Thou hast set a bound that they may not pass over; that they turn not again to cover the earth.

God promised Noah and He is telling us again that He will never flood the earth again like He did in the past. Now let's document from God's word that we lived in the first earth age. Lets go to the book of Job. Job's whole life fell apart as he was being tested by Satan and spent most of the book talking to his three friends. They all thought that they had the answers to why these things happened to Job. We are going to pick up the story with God's first address to Job.

Job 38:1-7

V1 Then the LORD answered Job out of the whirlwind, and said,

V2 Who is this that darkeneth counsel by words without knowledge?

V3 Gird up now thy loins like a man; for I will demand of thee, and answer thou Me.

God is asking Job why he listens to his friends when they have no idea what they are talking about. God is saying to Job, If you know so much, I'm going to ask you some questions and lets see you answer them. All of mankind put together knows very little compared to the wisdom of God.

V4 Where wast thou when I laid the foundations of the earth? declare, if thou hast understanding.

V5 Who hath laid the measures thereof, if thou knowest? or who hath stretched the line upon it?

V6 Whereupon are the foundations thereof fastened? or who laid the corner stone thereof;

God is asking Job where he was when He created the earth. This is something that happened many millions of years ago. God is taking us back to creation and the first earth age.

V7 When the morning stars sang together, and all the sons of God shouted for joy?

Not many people shouting for joy now a days. This is looking back in time when we all where happy in heaven and everything was going great. This happened before the rebellion of Satan. So now we know that there was an earth age before this one that we all lived in. There was no flesh in that earth age as we just had our spiritual bodies. God destroyed the first earth age completely because of the rebellion of Satan and that a third of His children followed Satan. He did that with a flood that covered the whole earth. By reading this study and the rebellion of Satan, you will know the answer to that age old question, "Why are we here?" I'll give you the answer now and it is why we are being tested. God wants to know who loves Him and who does not. That's it; plain and simple.

[back to index](#)

Rebellion of Satan

In this study we are going to take a look at what Satan was up to in the first earth age and what caused God to end that age. If you don't know that there are Three World Ages, you should also read that study (directly above) as it will help you understand this one. The things we are going to be talking about in this study happened a very long time ago. We were all happy in heaven which

was on earth at that time. We did not have flesh bodies but only spiritual ones. Satan who was called Lucifer back then was a good guy and had great responsibilities given to him by God. But one day, that all changed.

Isaiah 14:12-17

V12 How art thou fallen from heaven, O Lucifer, son of the morning! how art thou cut down to the ground, which didst weaken the nations!

The name 'Lucifer' is Strong's 1966 and means heylel (hay-lale'); from 1984 (in the sense of brightness); the morning-star. Strong's number 1984 is a primitive root; to be clear (orig. of sound, but usually of color); to shine; hence, to make a show, to boast; and thus to be (clamorously) foolish; to rave; causatively, to celebrate; also to stultify. The fall from heaven this is talking about happened in the first earth age. Lucifer use to be Satan's name but it was changed by God. For more information on Satan's names see our Other names for Satan study. Lucifer is the fake morning star, Christ is the true morning Star.

Revelation 22:16 - V16 I Jesus have sent Mine angel to testify unto you these things in the churches. I am the Root and the Offspring of David, and the bright and morning Star.

V13 For thou hast said in thine heart, I will ascend into heaven, I will exalt my throne above the stars of GOD: I will sit also upon the mount of the congregation, in the sides of the north:

Lucifer is really getting full of pride here. He wants to sit in the Divine assembly of judgment which in Psalms 82:1 we read that is God's job.

Psalms 82:1 - V1 God standeth in the congregation of the mighty; He judgeth among the gods.

He also wants to sit "in the sides of the north." The problem with that is, that is where God's throne is.

Psalms 75:6-7 - V6 For promotion cometh neither from the east, nor from the west, nor from the south. V7 But God is the judge: He putteth down one, and setteth up another.

V14 I will ascend above the heights of the clouds; I will be like the MOST HIGH.

The words "MOST HIGH" is Strong's 5945 and means 'elyown (el-yone'); from 5927; an elevation, i.e. (adj.) lofty (compar.); as title, the Supreme. That is one of the Divine names of God and is God as possessor of heaven and earth. Lucifer was so full of pride that he wanted to be God. Gee, I wonder what God thinks of that.

V15 Yet thou shalt be brought down to hell, to the sides of the pit.

God does not like people that are full of pride and will bring them down to size. Without repentance, as in the case of Lucifer, that means death of the soul.

V16 They that see thee shall narrowly look upon thee, and consider thee, saying, 'Is this the man that made the earth to tremble, that did shake kingdoms;

V17 That made the world as a wilderness, and destroyed the cities thereof; that opened not the house of his prisoners?'

This happens in the millennium when Satan is cast into the bottomless pit for a thousand years. People that are deceived by Satan thus receiving the Mark of the Beast, will be amazed that they were deceived by him, for he is just a man.

Revelation 20:2-3 - V2 And he laid hold on the dragon, that old serpent, which is the Devil, and Satan, and bound him a thousand years, V3 And cast him into the bottomless pit, and shut him up, and set a seal upon him, that he should deceive the nations no more, till the thousand years should be fulfilled: and after that he must be loosed a little season.

Lets go to Ezekiel 28 and read more about Satan's rebellion. Ezekiel 28:1-10 are after Satan's fall and verses 11-19 are about before his fall.

Ezekiel 28:1-19 - V1 The word of the LORD came again unto me, saying,

V2 Son of man, say unto the prince of Tyrus, Thus saith the Lord GOD; Because thine heart is lifted up, and thou hast said, I am a GOD, I sit in the seat of God, in the midst of the seas; yet thou art a man, and not GOD, though thou set thine heart as the heart of God:

The word "Tyrus" is Strong's 6865 and means Tsor (tsore); or Tsowr (tsore); the same as 6864; a rock; Tsor, a place in Palestine. Strong's 6864 is tsor (tsore); from 6696; a stone (as if pressed hard or to a point); (by implication, of use) a knife. Some may say that this is not talking about Satan at all but as we cover these verses you will see that it can be only him. Satan's heart was full of pride and he thought he was better than God. Seas as it is used here is symbolic of people. Satan is the false rock while Christ is our true Rock.

V3 Behold, thou art wiser than Daniel; there is no secret that they can hide from thee:

If you read the book of Daniel you will find that he was a very wise man. But Satan is even wiser. Satan knows the word of God very well, he just changes it around to suite his needs. He used God's word against Eve and he used it to test Christ.

V4 With thy wisdom and with thine understanding thou hast gotten thee riches, and hast gotten gold and silver into thy treasures:

V5 By thy great wisdom and by thy traffick hast thou increased thy riches, and thine heart is lifted up because of thy riches:

The word "traffick" is Strong's 7404 and means rekullah (rek-ool-law'); feminine passive participle of 7402; trade (as peddled). Strong's 7402 is rakal (raw-kal'); a primitive root; to travel for trading. Satan has used his great wisdom to get riches by lying and deceiving people. Just be wiser than Satan. Satan's heart is lifted up because of his riches but what is that going to get him in the end? A one way ticket to burn in hell.

V6 Therefore thus saith the Lord GOD; Because thou hast set thine heart as the heart of God;

Satan who is an unjust liar among other things wanted to be God. Thank God, Who is just and does not lie, didn't let it happen. There is only one true God and that's the way it will always be.

V7 Behold, therefore I will bring strangers upon thee, the terrible of the nations: and they shall draw their swords against the beauty of thy wisdom, and they shall defile thy brightness.

V8 They shall bring thee down to the pit, and thou shalt die the deaths of them that are slain in the midst of the seas.

The word "defile" is Strong's 2490 and means chahal (khaw-lal'); a primitive root [compare 2470]; properly, to bore, i.e. (by implication) to wound, to dissolve; figuratively, to profane (a person, place or thing), to break (one's word), to begin (as if by an "opening wedge"); denom. (from 2485) to play (the flute). The word "brightness" is Strong's 3314 and means yiph` ah (yif-aw'); from 3313; splendor or (figuratively) beauty: -brightness. For those that think these verses are not talking about Satan, yiph` ah is only used twice. Here and in verse 17 where when read with the verses before it, it is very clear that it is talking about Satan. The swords talked about here is the word of God. People will start to tell the truth about Satan and what his plans are which in turn will wound his brightness.

V9 Wilt thou yet say before Him That slayeth thee, I am God? but thou shalt be a man, and no GOD, in the hand of Him That slayeth thee.

V10 Thou shalt die the deaths of the uncircumcised by the hand of strangers: for I have spoken it, saith the Lord GOD.

The 'Him' in verse nine is referring to Jesus Christ. Christ will end Satan's reign of unrighteousness when He returns at the second

advent. Satan thinks that he is so big and bad but he is no match for Jesus Christ. Satan in due time will be killed and all that follow him will be killed also.

II Thessalonians 2:8 - V8 And then shall that wicked be revealed, whom the Lord shall consume with the spirit of His mouth, and shall destroy with the brightness of His coming:

Revelation 20:10 - V10 And the devil that deceived them was cast into the lake of fire and brimstone, where the beast and the false prophet are, and shall be tormented day and night for ever and ever.

Revelation 20:15 - V15 And whosoever was not found written in the book of life was cast into the lake of fire.

V11 Moreover the word of the LORD came unto me, saying,

V12 Son of man, take up a lamentation upon the king of Tyrus, and say unto him, Thus saith the Lord GOD; Thou sealest up the sum, full of wisdom, and perfect in beauty.

Remember that the word "Tyrus" means rock. Satan is the false rock, while Christ is the true Rock. Lucifer before he rebelled against God was perfect. He was very wise and beautiful.

V13 Thou hast been in Eden the garden of God; every precious stone was thy covering, the sardius, topaz, and the diamond, the beryl, the onyx, and the jasper, the sapphire, the emerald, and the carbuncle, and gold: the workmanship of thy tabrets and of thy pipes was prepared in thee in the day that thou wast created.

This tells us that Satan was in the garden of Eden in this earth age. This also goes on to tell us that Lucifer was very blessed in the first earth age. At one time, God was very pleased with him and gave him great responsibilities. God created Lucifer, he was not born of woman. Lucifer, who had his name changed to Satan by God, is a supernatural being. He has more powers than we do but even Satan has to ask God's permission to do something. Read the first two chapters of Job. Also, in Luke Christ gave us power over Satan.

Luke 10:18-20 - V18 And He said unto them, I beheld Satan as lightning fall from heaven. V19 Behold, I give unto you power to tread on serpents and scorpions, and over all the power of the enemy: and nothing shall by any means hurt you. V20 Notwithstanding in this rejoice not, that the spirits are subject unto you; but rather rejoice, because your names are written in heaven.

V14 Thou art the anointed cherub that covereth; and I have set thee so: thou wast upon the holy mountain of God; thou hast walked up and down in the midst of the stones of fire.

Lucifer's job in the first earth age was to protect the very throne of God in heaven. Stones of fire is God's altar.

V15 Thou wast perfect in thy ways from the day that thou wast created, till iniquity was found in thee.

Lucifer was perfect in God's eyes until evil was found in him.

V16 By the multitude of thy merchandise they have filled the midst of thee with violence, and thou hast sinned: therefore I will cast thee as profane out of the mountain of God: and I will destroy thee, O covering cherub, from the midst of the stones of fire.

The word "violence" is Strong's 2555 and means *chamac* (khaw-mawce'); from 2554; violence; by implication, wrong; by meton. unjust gain. Strong's 2554 is *chamac* (khaw-mas'); a primitive root; to be violent; by implication, to maltreat. Lucifer with his lies and deception received unjust gain and sinned. This happened in the first earth age and at that time a third of God's children followed after Lucifer.

Revelation 12:3-4 - V3 And there appeared another wonder in heaven; and behold a great red dragon, having seven heads and ten horns, and seven crowns upon his heads. V4 And his tail drew the third part of the stars of heaven, and did cast them to the earth: and the dragon stood before the woman which was ready to be delivered, for to devour her child as soon as it was born.

V17 Thine heart was lifted up because of thy beauty, thou hast corrupted thy wisdom by reason of thy brightness: I will cast thee to the ground, I will lay thee before kings, that they may behold thee.

Lucifer thought he was so good he wanted to be God. He became full of pride and would not change his ways, so God had to cast him out of heaven. These are the events that brought the first earth age to an end.

V18 Thou hast defiled thy sanctuaries by the multitude of thine iniquities, by the iniquity of thy traffick; therefore will I bring forth a fire from the midst of thee, it shall devour thee, and I will bring thee to ashes upon the earth in the sight of all them that behold thee.

V19 All they that know thee among the people shall be astonished at thee: thou shalt be a terror, and never shalt thou be any more.

Here Lucifer is sentenced to death by God Himself. If you ever wondered what hell is going to be like, these verses tell us. Satan and anyone else that is sentenced to death, God will destroy their soul with fire until the only thing left is ashes. So now we have a better understanding of who Satan is and what his job use to be. Because of Satan's rebellion and the fact that a third of God's children followed him, God ended the first earth age and started the second one. This is the one we are living in now. If no one followed after Satan when he rebelled in the first earth age, God would have just killed him then and you would not even be reading this study. But seeing that so many followed Satan, God ended that earth age and started the one we are living in now, the second earth age. If you ever wondered why we are here, the answer to that is simple. We are being tested. God wants to find out who loves and will follow Him and who is going to follow Satan. Their is no middle road; people are either for God or against Him. The fate of those against God is death.

[back to index](#)

Mark of the Beast Bible Study

Just what is the mark of the beast? Do some already have the mark of the beast and not even know it? Who is the beast? In Revelation chapter 13 there are two different beasts talked about. In Revelation 13:1-10 the first beast is the political system of the last days. The beast that I'm going to be talking about is in verses 11-18. This beast is a person as will shall see, someone that you probably already heard of. To better understand God's word we need to know that God uses symbology to explain some things. This is the beast of the last days and he shall come to this earth before our true Saviour, Jesus Christ does.

Revelation 13:11-18 - V11 And I beheld another beast coming up out of the earth; and he had two horns like a lamb, and he spake as a dragon.

Horns as it is used here stand for power. In this verse you read that the beast has two horns like a lamb. Not as a lamb but like a lamb. That is very important to understand. Who is our lamb? Our lamb is Jesus Christ of course. He is the Lamb of God and we can read that in the book of John.

John 1:29 - V29 The next day John seeth Jesus coming unto him, and saith, Behold the Lamb of God, which taketh away the sin of the world.

John 1:36 - V36 And looking upon Jesus as He walked, he saith, Behold the Lamb of God!

So what we have here right from the start is a fake lamb. Some one that thinks he is the Lamb of God but is not. Now this beast spake as a dragon. Who is the dragon in God's word? The dragon is Satan. That is just one of the names Satan goes by in the word of God.

Revelation 12:9 - V9 And the great dragon was cast out, that old serpent, called the Devil, and Satan, which deceiveth the whole world: he was cast out into the earth, and his angels were cast out with him.

Revelation 20:2 - V2 And he laid hold on the dragon, that old serpent, which is the Devil, and Satan, and bound him a thousand years.

V12 And he exerciseth all the power of the first beast before him, and causeth the earth and them which dwell therein to worship the first beast, whose deadly wound was healed.

Exerciseth means to make or do (in a very wide application, more or less direct) Here we have Satan directing the first beast (Rev 13:1-10) which is the political system of the last days. The thing is that he will not be directing it from where you might think he will be. Instead Satan will be here on this earth in person doing his directing. Satan will be cast out of heaven and down to this earth in the last days.

Revelation 12:7-9 - V7 And there was war in heaven: Michael and his angels fought against the dragon; and the dragon fought and his angels, V8 And prevailed not; neither was their place found any more in heaven. V9 And the great dragon was cast out, that old serpent, called the Devil, and Satan, which deceiveth the whole world: he was cast out into the earth, and his angels were cast out with him.

V13 And he doeth great wonders, so that he maketh fire come down from heaven on the earth in the sight of men,

When Satan comes back to this earth he will have supernatural powers able to do miracles that will deceive many. He will be able to have lightning come down from heaven.

V14 And deceiveth them that dwell on the earth by the means of those miracles which he had power to do in the sight of the beast; saying to them that dwell on the earth, that they should make an image to the beast, which had the wound by a sword, and did live.

Satan is the king of deception. Satan will say that the people should make a image to the 1st beast that was wounded by a sword. The sword is the word of God.

Ephesians 6:17 - V17 And take the helmet of salvation, and the sword of the Spirit, which is the word of God:

V15 And he had power to give life unto the image of the beast, that the image of the beast should both speak, and cause that as many as would not worship the image of the beast should be killed.

This is why so many Christians may be afraid to be here during the tribulation, they think they are going to be killed. Satan is going to be here on earth saying that he is Jesus Christ. Satan can't have people thinking he is Jesus if he is going around having people killed. The only people that will be killed by him are the two witness so that scripture may be fulfilled.

Revelation 11:3-7

V3 And I will give power unto My two witnesses, and they shall prophesy a thousand two hundred and threescore days, clothed in sackcloth.

V4 These are the two olive trees, and the two candlesticks standing before the God of the earth.

V5 And if any man will hurt them, fire proceedeth out of their mouth, and devoureth their enemies: and if any man will hurt them, he must in this manner be killed.

V6 These have power to shut heaven, that it rain not in the days of their prophecy: and have power over waters to turn them to blood, and to smite the earth with all plagues, as often as they will.

V7 And when they shall have finished their testimony, the beast that ascendeth out of the bottomless pit shall make war against them, and shall overcome them, and kill them.

Satan may want others that don't worship the image to be killed but it will not happen.

Revelation 9:1-5 - V1 And the fifth angel sounded, and I saw a star fall from heaven unto the earth: and to him was given the key of the bottomless pit. V2 And he opened the bottomless pit; and there arose a smoke out of the pit, as the smoke of a great furnace; and the sun and the air were darkened by reason of the smoke of the pit. V3 And there came out of the smoke locusts upon the earth: and unto them was given power, as the scorpions of the earth have power. V4 And it was commanded them that they should not hurt the grass of the earth, neither any green thing, neither any tree; but only those men which have not the seal of God in their foreheads. V5 And to them it was given that they should not kill them, but that they should be tormented five months: and their torment was as the torment of a scorpion, when he striketh a man.

V16 And he causeth all, both small and great, rich and poor, free and bond, to receive a mark in their right hand, or in their foreheads:

What is in our foreheads? Our brain, our mind, that which we use to think. What this is saying is that people will receive a mark in their mind and that mark is deception. Believing in things like a rapture so that you will not be here for the tribulation. Believing that the 1st one that comes to this earth with supernatural powers is Jesus Christ. The 1st one back with supernatural powers is not Jesus Christ but Satan himself. He will say that he is Jesus but as always he is lying and is not the true Christ. It clearly tells us in II Thessalonians 2:1-4 that the true Christ will not come until Satan comes back to this earth.

II Thessalonians 2:1-4 - V1 Now we beseech you, brethren, by the coming of our Lord Jesus Christ, and by our gathering together unto him, V2 That ye be not soon shaken in mind, or be troubled, neither by spirit, nor by word, nor by letter as from us, as that the day of Christ is at hand. V3 Let no man deceive you by any means: for that day shall not come, except there come a falling away first, and that man of sin be revealed, the son of perdition; V4 Who opposeth and exalteth himself above all that is called God, or that is worshipped; so that he as God sitteth in the temple of God, shewing himself that he is God.

To receive the mark in your hand means that you are doing the work of Satan. Things like spreading the lie of the rapture. Saying that you don't need to read the whole book of Revelation because you think you will be gone. Satan is the antichrist of the last days and will deceive many.

V17 And that no man might buy or sell, save he that had the mark, or the name of the beast, or the number of his name.

The people that don't get the mark of the beast may not be able to buy or sell in the world that Satan will be running when he comes back. But not to worry, for God will always take care of His own! We do not want anything that Satan has to offer anyway. After all, what can he offer us? Satan is marked for death by God. Therefore, that's all Satan can offer you, is a one way ticket to hell. You don't want that, do you?

V18 Here is wisdom. Let him that hath understanding count the number of the beast: for it is the number of a man; and his number is Six hundred threescore and six.

No big mystery here, verse 11 already told us who the beast is, Satan. It is not someone on this earth now so don't bother trying to use someone's name that is here now. The beast is Satan. The antichrist is Satan. Satan has been going against God's will from the beginning chapters of Genesis. He is the one that thinks he is God and in the last days he will get some time here on earth to pretend that he is. Count here means a pebble (as worn smooth by handling), i.e. (by implication of use as a counter or ballot) a verdict (of acquittal) or ticket (of admission); a vote. The key word here is pebble. What is a pebble but a very small rock. Who is our Rock? Jesus Christ of course. He is the true Rock. What we have here is the fake rock, the antichrist of the last days. We can read that Jesus is our Rock in I Corinthians 10:4

I Corinthians 10:4 - V4 And did all drink the same spiritual drink: for they drank of that spiritual Rock that followed them: and that Rock was Christ.

It takes many years for a pebble to become smooth. The pebble is also symbolic for people, a certain kind of people, the Kenites. The mark of the beast started in the early chapters of Genesis. It is a spiritual mark that was put on Cain, and his offspring the Kenites. To read about the beginning of the mark of the beast, take a look at our Bible study on the Garden of Eden.

Satan will be coming back to this earth some time in the future, claiming to be Jesus Christ. Satan will have supernatural powers when he returns, able to deceive many. The mark of the beast is not a tattoo or some kind of chip that people think will be put in their body at that time. Satan is too smart for that. What we are talking about here, are things on a spiritual level. The mark of the

beast is deception. What you think and what you do. Many already have the mark of the beast today. They believe and spread the lie of the rapture, claiming that they will not be here for the tribulation. Claiming they don't need to read the whole book of Revelation because they think they will be gone, that they will be raptured away. Well, God's word says otherwise. There is no rapture and believing that there is, is part of the mark of the beast.

[back to index](#)

Rapture of the Church Bible Study



The rapture is what many Christians believe to be that Jesus Christ is going to come for them before the great tribulation. Is the rapture from the word of God? Lets turn to I Thessalonians 4 the place where many get the idea for the rapture.

I Thessalonians 4:13-18

The subject is where are the dead.

V13 But I would not have you to be ignorant, brethren, concerning them which are asleep, that ye sorrow not, even as others which have no hope.

asleep in Greek means to decease, to be dead. This is talking about people that are already dead not people that are living on earth now. The second our flesh body dies our soul goes back to God.

Ecclesiastes 12:7 - V7 Then shall the dust return to the earth as it was: and the spirit shall return unto God who gave it.

We can take comfort knowing that our loved ones who have passed on are with God our Father and not lying in a hole in the ground. The flesh body stays in the ground but our soul goes back to God. The people that have no hope are those that do not believe in Jesus Christ as the only begotten Son of God.

V14 For if we believe that Jesus died and rose again, even so them also which sleep in Jesus will God bring with him.

This is talking about people that have passed on that believed in Jesus Christ as the Son of God.

V15 For this we say unto you by the word of the Lord, that we which are alive and remain unto the coming of the Lord shall not prevent them which are asleep.

Prevent means to precede before hand, to have arrived at already. We are still talking about where the dead are the subject has not changed. This verse tells us that people that have died are already with Jesus. The people alive when Jesus returns will not be with Jesus before the people that have already passed away because they are already there.

V16 For the Lord himself shall descend from heaven with a shout, with the voice of the archangel, and with the trump of God: and

the dead in Christ shall rise first:

This tells us when Jesus will return and not before. This is not the rapture. The rapture is a lie and can not be found in God's word. This is talking about the second coming of Jesus at the end of the tribulation. Jesus will come at the seventh trump and not before the seventh trump for anyone. Those that have died already rise first because they are already with Jesus. The second we die we go back to God our Father.

V17 Then we which are alive and remain shall be caught up together with them in the clouds, to meet the Lord in the air: and so shall we ever be with the Lord.

This happens after the tribulation when Jesus returns as Lord of lords and King of kings. This is not talking about a rapture, there is no rapture. Clouds is symbolic for a mass of people.

Hebrews 12:1 - V1 Wherefore seeing we also are compassed about with so great a cloud of witnesses, let us lay aside every weight, and the sin which doth so easily beset us, and let us run with patience the race that is set before us,

When Jesus returns at the seventh trump the people alive on earth at that time will be changed into their spiritual bodies in the twinkling of an eye.

I Corinthians 15:52-53 - V52 In a moment, in the twinkling of an eye, at the last trump: for the trumpet shall sound, and the dead shall be raised incorruptible, and we shall be changed. V53 For this corruptible must put on incorruption, and this mortal must put on immortality.

The rapture is a lie from Satan trying to trick God's children into believing in a easy way out. Always remember as long as we are still in our flesh bodies the true Christ has not returned yet. Satan will come back to this earth with supernatural powers saying he is Christ here to rapture you away, but it is a lie.

V18 Wherefore comfort one another with these words.

We can comfort our loved ones and friends when they lose some one they love because we can tell them where their loved ones are when they pass away. The moment some one dies they go back to God our Father.

You may be surprised to know that God's word does say something about people teaching you to fly away to try to save your soul. What does God's word say about this, lets go to Ezekiel 13 to find out.

Ezekiel 13:16-23

V16 To wit, the prophets of Israel which prophesy concerning Jerusalem, and which see visions of peace for her, and there is no peace, saith the Lord GOD

Their will be no true peace until Jesus returns to this earth after the antichrist has been here and not before, for anyone. Some people believe in the false peace of the rapture and it is just that a false peace. The prophets talked about here are false prophets not teaching the true word of God. People telling you that you don't have to read the book of Revelation because you'll be gone. They are lying to you, there is no rapture and God is against people that tell you their is.

V17 Likewise, thou son of man, set thy face against the daughters of thy people, which prophesy out of their own heart; and prophesy thou against them,

This is telling people who know the truth to tell the truth to God's other children. The ones that prophesy out of their own heart are ones that go on teaching the lie that there is a rapture when God Himself said that it's not true.

V18 And say, Thus saith the Lord GOD; Woe to the women that sew pillows to all armholes, and make kerchiefs upon the head of every stature to hunt souls! Will ye hunt the souls of my people, and will ye save the souls alive that come unto you?

The pillows and kerchiefs these false prophets use to cover the outstretched arms of Jesus by teaching the lie of the rapture. The

people that teach others the rapture are leading them right to the arms of the antichrist. Nowhere in the word of God does it say that Jesus will come for anybody before the great tribulation. God asked if these false prophets will save these people that they lie to by teaching them the rapture. When in fact these false prophets are leading these people straight to death, the antichrist. Only Jesus Christ can save somebody.

V19 And will ye pollute me among my people for handfuls of barley and for pieces of bread, to slay the souls that should not die, and to save the souls alive that should not live, by your lying to my people that hear your lies?

Some people are lying to God's children just for money. They are slaying souls by teaching people the rapture which will lead them right into the arms of the antichrist when he comes to earth claiming to be Jesus Christ.

V20 Wherefore thus saith the Lord GOD; Behold, I am against your pillows, wherewith ye there hunt the souls to make them fly, and I will tear them from your arms, and will let the souls go, even the souls that ye hunt to make them fly.

God Himself is against the teaching of a quick escape to save your soul. God is saying that there is no rapture. The true Jesus Christ is not coming back for anyone until after the antichrist has already been on earth, God said so. God is against people that teach lies to His children about the rapture. It covers the outstretched arms of the true Jesus by leading His children right into the arms of the antichrist.

V21 Your kerchiefs also will I tear, and deliver my people out of your hand, and they shall be no more in your hand to be hunted; and ye shall know that I am the LORD.

God will save His people from the lie of the rapture by giving the truth in His word. Read the word on your own and ask God to give you understanding in His word so you can see the truth about the rapture.

V22 Because with lies ye have made the heart of the righteous sad, whom I have not made sad; and strengthened the hands of the wicked, that he should not return from his wicked way, by promising him life:

The righteous is Jesus Christ, we all fall short to His righteousness. God is telling us by people teaching the lie of the rapture Jesus becomes sad. Sad because they are being deceived and lead straight to the antichrist. By teaching the rapture people strengthen the hand of Satan who is the antichrist.

V23 Therefore ye shall see no more vanity, nor divine divinations: for I will deliver my people out of your hand: and ye shall know that I am the LORD.

God will deliver His people by giving them the truth in His word.

In II Thessalonians 2:1-12 it talks about the return of Jesus Christ. It tells us there are certain things that must happen before Jesus returns to this earth.

II Thessalonians 2:1-12

V1 Now we beseech you, brethren, by the coming of our Lord Jesus Christ, and by our gathering together unto him,

Beseech means to ask or request a person to do something. This is telling us to pay attention because this tells us what must happen before Jesus returns.

V2 That ye be not soon shaken in mind, or be troubled, neither by spirit, nor by word, nor by letter as from us, as that the day of Christ is at hand.

This is saying don't believe people when they say Jesus Christ can come at any time. There are things that must happen before Jesus returns.

V3 Let no man deceive you by any means: for that day shall not come, except there come a falling away first, and that man of sin be revealed, the son of perdition;

Don't let any one deceive you, read God's word with understanding. This verse tells us that Jesus will not return until the son of perdition be revealed. Perdition means to perish and die. Satan is the only one who has been sentenced to death by God so far.

Ezekiel 28:11-19

V11 Moreover the word of the LORD came unto me, saying,

V12 Son of man, take up a lamentation upon the king of Tyrus, and say unto him, Thus saith the Lord GOD; Thou sealest up the sum, full of wisdom, and perfect in beauty.

V13 Thou hast been in Eden the garden of God; every precious stone was thy covering, the sardius, topaz, and the diamond, the beryl, the onyx, and the jasper, the sapphire, the emerald, and the carbuncle, and gold: the workmanship of thy tabrets and of thy pipes was prepared in thee in the day that thou wast created.

V14 Thou art the anointed cherub that covereth; and I have set thee so: thou wast upon the holy mountain of God; thou hast walked up and down in the midst of the stones of fire.

V15 Thou wast perfect in thy ways from the day that thou wast created, till iniquity was found in thee.

V16 By the multitude of thy merchandise they have filled the midst of thee with violence, and thou hast sinned: therefore I will cast thee as profane out of the mountain of God: and I will destroy thee, O covering cherub, from the midst of the stones of fire.

V17 Thine heart was lifted up because of thy beauty, thou hast corrupted thy wisdom by reason of thy brightness: I will cast thee to the ground, I will lay thee before kings, that they may behold thee.

V18 Thou hast defiled thy sanctuaries by the multitude of thine iniquities, by the iniquity of thy traffick; therefore will I bring forth a fire from the midst of thee, it shall devour thee, and I will bring thee to ashes upon the earth in the sight of all them that behold thee.

V19 All they that know thee among the people shall be astonished at thee: thou shalt be a terror, and never shalt thou be any more.

John 17:12

V12 While I was with them in the world, I kept them in Thy name: those that Thou gavest Me I have kept, and none of them is lost, but the son of perdition; that the scripture might be fulfilled.

II Thessalonians verse 3 tells us that Jesus will not come for anyone until Satan is revealed. There is no rapture. Jesus will not come for anybody until that happens. Satan is the one that deceives the world and that can be read in Revelation 12:9 and 20:10

Revelation 12:9 - V9 And the great dragon was cast out, that old serpent, called the Devil, and Satan, which deceiveth the whole world: he was cast out into the earth, and his angels were cast out with him.

Revelation 20:10 - V10 And the devil that deceived them was cast into the lake of fire and brimstone, where the beast and the false prophet are, and shall be tormented day and night for ever and ever.

V4 Who opposeth and exalteth himself above all that is called God, or that is worshipped; so that he as God sitteth in the temple of God, shewing himself that he is God.

Satan is the antichrist and will return to this earth with supernatural powers able to have lightning fall from heaven. Many will be deceived and think that he is Jesus here to rapture them away. Satan will sit in the temple of God which is in Jerusalem.

V6 And now ye know what withholdeth that he might be revealed in his time.

V7 For the mystery of iniquity doth already work: only he who now letteth will let, until he be taken out of the way.

Satan will be cast out of heaven down to earth to play the roll of Jesus Christ. Satan will say that he is here to rapture you away but as always Satan is lying. Satan will be cast out of heaven by Michael in the last days.

Revelation 12:7-9 - V7 And there was war in heaven: Michael and his angels fought against the dragon; and the dragon fought and his angels, V8 And prevailed not; neither was their place found any more in heaven. V9 And the great dragon was cast out, that old serpent, called the Devil, and Satan, which deceiveth the whole world: he was cast out into the earth, and his angels were cast out with him.

This will happen before the true Jesus returns to this earth. The true Jesus will not come for any one until Satan is already here on earth.

V8 And then shall that Wicked be revealed, whom the Lord shall consume with the spirit of his mouth, and shall destroy with the brightness of his coming:

This is when Satan is on this earth saying he is Jesus here to rapture you away. Then the true Jesus returns to earth as King of kings and Lord of lords and Satan is bound for a thousand years.

Revelation 20:1-3 - V1 And I saw an angel come down from heaven, having the key of the bottomless pit and a great chain in his hand. V2 And he laid hold on the dragon, that old serpent, which is the Devil, and Satan, and bound him a thousand years, V3 And cast him into the bottomless pit, and shut him up, and set a seal upon him, that he should deceive the nations no more, till the thousand years should be fulfilled: and after that he must be loosed a little season.

V9 Even him, whose coming is after the working of Satan with all power and signs and lying wonders,

Jesus returns after Satan has already been on earth claiming to be Jesus saying he is here to rapture you away. Satan is the antichrist and he will come before the true Jesus Christ.

V10 And with all deceivableness of unrighteousness in them that perish; because they received not the love of the truth, that they might be saved.

Many will be deceived by Satan because he is the king of deception. He will have supernatural powers and many will believe that he is Jesus because they did not receive the truth in God's word. We need to read the word of God on our own and ask Him to give us understanding in His word. Don't believe what anyone tells you read God's word for your self it's your life.

V11 And for this cause God shall send them strong delusion, that they should believe a lie:

V12 That they all might be damned who believed not the truth, but had pleasure in unrighteousness.

People who don't read God's word with understanding and do not believe in the truth of His word will go on believing in lies. We are to study God's word.

II Timothy 2:15 - V15 Study to shew thyself approved unto God, a workman that needeth not to be ashamed, rightly dividing the word of truth.

Read God's word and ask Him to give you understanding in His word. The rapture is a total lie from Satan himself. Nowhere in God's word does it say that Jesus will come back for any one before Satan comes to earth as the antichrist. As long as we are still in our flesh bodies the true Jesus Christ has not returned yet.

[back to index](#)

The Rapture:

The Lie that Leads To The Beast!

All my Life I believed in "The Rapture". Before I was a Christian I believed that all the Christians would just disappear from the planet! Why shouldn't I believe it? The vast majority of Television preachers told me it was going to happen every week. The Preachers there told us that we had "better accept Jesus or be left behind". I accepted it as a Biblical fact, never once questioning those who espoused it; after all, the majority of those who were calling themselves "Christians" believed in a Rapture or the belief that Jesus would return "HALF WAY to the Earth", and all of the Christians would "disappear from the planet", while The Anti-Christ and The Beast reigned on The Earth.

So, the question formed in my mind - was it true? My preachers told me that I would "burn in Hell" if I died a sinner, and that I would be "tormented forever", yet The Holy Bible says "The Wages of Sin is DEATH"! I chose to ignore the preachers, and Study The Bible for myself, either to believe what *It's CREATOR SAID*, or to be more versed in it than the Preachers, so that I might use it against them! As I began researching The Bible, I began to see a pattern. The Bible stated one thing, and the majority of the "preachers" that I saw on television and locally said something diametrically opposed to what The Bible said. So, who was I to believe? Did I believe the Bible, or the men who claimed to represent The Creator God of The Bible? I chose to Believe the God of The Bible, and to cast aside the majority of those who "claimed" to Represent Jesus Christ. My problems with the "Traditional" Churches arose, when I asked a few questions like:

- 1.) What happened in The Garden of Eden?
- 2.) What was The Mark that God put on Cain?
- 3.) Who was Cain's Wife?
- 4.) What about The Giants spoken of in Genesis?
- 5.) What was The Mark of The Beast?

As my knowledge of The Bible grew, the urge to be able to answer these questions grew, so I began researching God's Word in The Original Inspired Languages. God said that IF we seek Him diligently, we would find Him. I prayed to God for Guidance, Wisdom in His Word, Understanding, and Patience. I have come to believe that "The Rapture" teachings will lead people to the worship of the Anti-Christ! *After much research and prayer, I have not found one single piece of Scripture that reveals a "Rapture"!* In fact, I have found just the opposite!

So, please read this study, and decide for yourself whether you will accept the Words of The God of The Bible, or The Words of the men who "claim" to represent Him, because there are MAJOR disputes between the two. One is right, and one is wrong; which will you believe? The Word of God, or MEN who MAKE A LIVING by preaching? I pray that you will Understand and Receive The Truth that IS The Word Of God. **Let Him that Hath an Ear Hear!**

The Twisted Scripture

The preachers who teach a "rapture" have just a few pieces of scripture that they use as "evidence" of it occurring, while there are numerous Scriptures which proclaim that there is NO RAPTURE! The best way to begin this is to show what is used as "Rapture Scripture", and then show how these Scriptures have been taken out of context, and what The Bible reveals concerning these scriptures. Here are the TWO pieces of "evidence" that "The Rapture" is based upon:

1st. Thessalonians 4:16-17

4:16 For the Lord himself shall descend from heaven with a shout, with the voice of the archangel, and with the trump of God: and the dead in Christ shall rise first:

4:17 Then we which are alive and remain shall be caught up together with them in the CLOUDS, to meet the Lord in the AIR

1st. Corinthians 15:50-54

50 Now this I say, brethren, that flesh and blood cannot inherit the kingdom of God; neither doth corruption inherit incorruption.

51 Behold, I show you a mystery; We shall not all sleep, but WE SHALL ALL BE CHANGED,

52 In a moment, in the twinkling of an eye, AT THE LAST TRUMP: for the trumpet shall sound, and the dead shall be raised incorruptible, and WE SHALL BE CHANGED.

53 For this corruptible must put on incorruption, and this mortal must put on immortality.

54 So when this corruptible shall have put on incorruption, and this mortal shall have put on immortality, then shall be brought to pass the saying that is written, Death is swallowed up in victory.

Let's take this one at a time. The terms "clouds" and "air" are what confuse the "rapture pastors" in 1st. Thessalonians 4:16-17.

These "clouds" spoken of are simply large Groups of God's People who are also compared/called Clouds in Hebrews 12:1, which states "Wherefore, seeing we also are compassed about with so great a cloud of witnesses". The term Air here does not mean Air as in the sky/Atmosphere, there is a completely different Greek term that appears for that. THIS term translated as air, means The BREATH, or SPIRIT of GOD. This is further revealed in 1st. Corinthians 15:51-53 where it states that "...we shall all be changed... at the last trump...this corruptible must put on incorruption...". What is this saying? It is saying that We shall be Converted into SPIRIT BODIES at The LAST TRUMP, when Christ RETURNS! This takes place on the FIRST DAY of the Millennium.

In 1st. Corinthians 15:50-54, it is just a simple matter of looking at WHAT ACTION takes place WHEN! Verse 51 states that we ALL SHALL BE CHANGED, and verse 52 states that this change will take place AT THE LAST TRUMP. The Last Trump is The SEVENTH TRUMP. This little fact itself, reveals that there IS NO RAPTURE!

Why? Because Satan, The Anti-Christ, will come to Earth at the SIXTH TRUMP! Which means that this CHANGE that Occurs at The LAST TRUMP, doesn't happen until AFTER THE ANTI-CHRIST IS REIGNING ON EARTH!

One Last time...let's review this because your very soul depends on knowing what will happen in the "last days".

Many will teach that you do not need to read, study, learn the book of Revelation (Rev.) in its entirety because the church will not be here after chapter 4! They teach the church is rapture away in Rev 4:1. Folks take a close look at chapter 4 verse one and two. It does not say the church but "I John was in the spirit!"

Reve 4:1 (KJS) After this I looked, and, behold, a door was opened in heaven: and the first voice which I heard was as it were of a trumpet talking with me; which said, Come up hither, and I will shew thee things which must be hereafter. 2 And immediately I was in the spirit: and, behold, a throne was set in heaven, and one sat on the throne.

John was taken to the Lord's day. The Lord's day is as 1000 years, ie: the millennium (2Pet 3:9). Note: How did John appear before the throne? In the spirit!

Roma 8:8 (KJS) So then they that are in the flesh cannot please God.

They will also tell you the word "church" does not appear in God's word after chapter 4 of this book Rev, like they would know! I will ask you to put aside your traditions and open your minds to the word of God!

Reve 1:3 (KJS) Blessed is he that readeth, and they that hear the words of this prophecy, and keep those things which are written therein: for the time is at hand.

God's word states Blessed is he that readeth and they that hear the words of this PROPHECY, which is not part, but the complete book of Revelation!

Reve 22:16 (KJS) I Jesus have sent mine angel to testify unto you these things in the churches. I am the root and the offspring of David, and the bright and morning star.

Note right off, God's word prove's them ignorant, the word churches does appear after chapter 4 in the book of Rev. God's word

states to testify unto you these things in the churches! God does not say just chapter 1-4 and/or 20-22.

I hope we can agree to include the book of Rev. in our study for the word of God tells us too. Excuse me, instructs us, to testify unto you these things in the churches.

Second, lets clarify the definition of the word "Rapture" and where it originated? "Rapture" refers to the "Gathering Back To Our Lord Jesus Christ;" The word "Rapture" does not appear in the bible, no, not even once. The word "Rapture" is the English version, of the Latin translation, of the Greek word 'harpazo'. This is the verb found in 1 Thes 4:17 meaning to 'catch away' as if from sudden danger.

In other words, they refer to the word "Rapture" to mean the church, (equals the body of Christ,) will "gather back to our Lord Jesus Christ" before the tribulation. The tribulation is the time of the false prophet, the anti-christ who comes defacto here on earth, who is no other than the son of perdition, satan himself. They get this so-called "Rapture Theory" primarily from a passage in 1Thes 4:13-18 and then support their translation with a verse here and a verse there throughout the word of God.

The great error, is the subject in 1Thes 4:13-18. The subject and the question being addressed in 1Thes 4:13-18 is where are the dead! The subject in 2Thes 2:1 and through-out the whole chapter of 2Thes is, when is the "Gathering Back to our Lord Jesus Christ." The answer of when is the Gathering Back, the "Rapture" is clearly given in 2Thes chapter 2 and support by many other chapters in the word of God.

When I speak of time I am speaking of before, during, or after the tribulation. I am not referring to the hour! The time of the gathering back is not given in 1Thes 4:13-18 unless you do a study on the word "trump" used in 1Thes 4:16. This is the only clue in that passage that would indicate when we will be gathered back.

God does tell us the events to occur regarding His gathering back through Paul in 2Thes chapter 2, Matt 24, Mark 13, Luke 21, and throughout the book of Rev. As well as many other single verses we could use through-out the word of God, like Eze 13:20.

I think both sides of this issue in the Christian family would agree there will be a gathering back to our Lord Jesus Christ. The division:

1. Who is Raptured
2. When is the Rapture
3. What occurs during and after the Rapture
4. In what body one is Raptured

Why is it important to know God's truth regarding His word in these end times: God tells us why:

Rev 20:4 And I saw thrones, and they sat upon them, and judgement was given unto them: and I saw the souls of them that were beheaded for the witness of Jesus, and for the word of God, and which had not worshiped the beast, neither his image, neither had received his mark upon their foreheads, or in their hands; and they lived and reigned with Christ a thousand years.

All I ask is you read God's word with an open mind and learn God's truth from his word!

Ok. Let's all pray for a word of wisdom and get into God's word. Father we come to you now searching for the truth in your word, let the Holy Spirit move, guide, direct, and provide us with the truth and wisdom in your word, in the Lord Jesus Christ name we ask, Amen.

Let's start with Paul's writing of 1Thes 4:13-18:

1Thes 4:13 But I would not have you to be ignorant, brethren, concerning them which are asleep, that ye sorrow not, even as others which have no hope.

This is the subject written about in 1Thes 4:13-18! I would not have you be ignorant concerning them which are dead from the flesh (asleep).

1Thes 4:14 - For if we believe that Jesus died and rose again, even so them also which sleep in Jesus will God bring with him.

God returns with those that are asleep in Him. All who died before the Lord's Day (the millennium) and had faith, witnessed by repentance to Him, will come with Him on the Lord's Day. (Rev. 19:14)

1Thes 4:15 - For this we say unto you by the word of the Lord that we which are alive and remain unto the coming of the Lord shall not prevent them which are asleep.

Why? Because those that are asleep they are already with Him! (Ecc 12:7)

1Thes 4:16 - For the Lord himself shall descend from heaven with a shout, with the voice of the archangel, and with the trump of God: and the dead in Christ shall rise first:

Now where in 1Thes 4:16 does it say before the tribulation, during, or after? The only clue regarding the time in this passage is the word "with the trump of God" to know the time one must know the trumps! Notice Paul tells us in 1Cor 15:52 this trump is the "last trump!"

1Cor 15:52 (KJS) In a moment, in the twinkling of an eye, at the last trump: for the trumpet shall sound, and the dead shall be raised incorruptible, and we shall be changed.

When we do a study on the word trump we will find 7 trumps mentioned in the book of Rev. With the 7th trump being the last trump and announcing the coming of Lord Jesus Christ. Rev. 11:15 is the 7th trump. The 7th trump is the last trump and follows the sixth trump. The sixth trump announces the coming of the false prophet, satan himself. Let's continue.

1Thes 4:17 Then we which are alive and remain shall be caught up together with them in the clouds, to meet the Lord in the air: and so shall we ever be with the Lord.

Do a study in the Greek on the word "clouds" and "air." Note: Paul uses the word "cloud" to mean a large gathering Heb 12:1.

Heb 12:1 Wherefore seeing we also are compassed about with so great a cloud of witnesses, let us lay aside every weight, and the sin which doth so easily beset us, and let us run with patience the race that is set before us,

Check the word "cloud" out in the Greek, as used in Hebrews 12:1 and 1Thes 4:17 they are defined the same. We also know Christ returns with an army in Rev 19:14 which is told to us again 1Thes 4:14. Let us look at this word "air" as defined by the Strong's Concordance Greek Definition #109 ah-ayr` from aemi (to breathe unconsciously, ie respire; by anal. to blow); air (as naturally circumambient):

Now, I am going to present you with an interpretation that can be made from the Greek of how this verse should read in today's modern English language.

1Thes 4:17 Then we which are alive in the flesh and WAIT for His return shall be gathered up together with them in a large gathering, to meet the Lord in the breath of life: and so shall we ever be with the Lord.

His breath of life is eternal life. NOTE: remain = wait for His return = not flying off to the first one that comes claiming he is God. For woe to them that are with child (satan) when he returns. We are to be virgin brides (spiritual speaking) when he comes not married to a spurious messiah whom is claiming to be God.

The point is you cannot know the time, as before, or middle, or after the tribulation from 1Thes 4:13-18 without examining closely 1Thes 4:16. To know the seventh trump is the last trump one must study the book of Rev. past chapter 4. For there is only one trump which sounds announcing the Lord's coming! The seventh trump after the 6th trump! Let's recap!

1Thes 4:16- Who are the dead in Christ? Are they not the ones who have already lived in the flesh, died in the flesh, and did have faith in God? Is not the dead in Christ all ready with Christ? read 1Thes 4:14 again,

1Thes 4:14 - For if we believe that Jesus died and rose again, even so them also which sleep in Jesus will God bring with him.

They are with him, asleep and will return with Him. They are the army spoken about in Rev 19:14 they are the cloud of witnesses that come with Him;

Yes we will be gather back to the Lord but not until the Lord's trump has sounded as stated in verse 16 of 1Thes 4;. This trump, the Lord's trump, is the last trump 1Cor 15:52; Rev 11:15; Do a study on all the trumps in the book of Revelation! Seven in biblical numerics means "Spiritually complete." When you are done with your study of the trumps you will find the 6th trump to be satan's followed by the 7th trump which is our Lord Jesus Christ trump, the last trump.

Now let us go to 2Thes 2:1-10. This is the letter Paul wrote the church which deals with the very subject and time of our Gathering Back!

2Thes 2:1 Now we beseech you, brethren by the coming of our Lord Jesus Christ, and by our gathering together unto him,

This is the SUBJECT of Paul's letter to the Thessalonians, to the church. I cannot emphasize this enough! This is the chapter that

deals with the subject of our Gathering Back. Paul is showing you the subject completely here in 2Thes chapter 2. not from some translation of a verb from the Greek to Latin to English but here in one verse the subject in detail through-out this entire chapter.

2Thes 2:2 That ye be not soon shaken in mind, or be troubled, neither by spirit, nor by word, nor by letter as from us, as that the day of Christ is at hand.

Remember the question again is when is this rapture, and he tells you, do not be troubled by my first letter in 1Thes 4; why because he shall make it clear with this letter, this, an entire chapter on the subject. Not with some translation of a verb from the Greek to Latin to English but clear here in this chapter of when that time shall be:

2Thes 2:3 Let no man deceive you by any means: for that day shall not come except there come a falling away first, and that man of sin be revealed, *the son of perdition;

Here it is, that day shall not come except there come a falling away, FIRST, what day? The day of the gathering back to our Lord Jesus Christ, the subject in verse 1! Let us examine this verse carefully. Here is the time a falling away first. falling away = Greek #646 = apostasia = defection from the truth; to be deceived;

(The falling away to be deceived from the truth. Who is the father of deception? satan. satan will come and many will believe his lies instead of the truth. They will fall away from the word of God ie: His truth!)

Paul clearly stating the time after the falling away: Who is the "Son of Perdition?" Let's go to the Greek and look at this word perdition. (using a Strong's concordance) perdition = apoleia = Greek #684 with the prime being #622 = apollumi = which is a part of #623 = Apolluon = a destroyer (ie: Satan); -Apollyn.

Rev 17:8 The beast that thou sawest was, and is not; and shall ascend out of the bottomless pit, and go into perdition: and they that dwell on the earth shall wonder, whose names were not written in the book of life from the foundation of the world, when they beheld the beast that was, and is not, and yet is.

Satan is the only one, at this time, that has been sentenced to death: Eze 28:18.

Eze 28:18 Thou hast defiled thy sanctuaries by the multitude of thine iniquities, by the iniquity of thy traffick; therefore will I bring forth a fire from the midst of thee, it shall devour thee, and I will bring thee to ashes upon the earth in the sight of all them that behold thee.

The son of perdition is none other than Satan himself. Their is only one who God has sentence to Perdition. Check the Strong's = Greek #622 = perish = Greek #623 = appolyon, which is one of Satan's names! No one can be classified as going into perdition UNTIL AFTER the great white throne judgement, or one has been judged by God. The son of perdition = Satan = and he is the only one to be sentenced to perdition or to perish. He is condemned to death.

Let's recap ... There is no way our Lord Jesus Christ is going to return to this earth which is the beginning of the Lord's day, the millennium, until after there is a great falling away because the son of perdition, "who is Satan," is going to be revealed on this earth doing lets continue:

2Thes 2:4 Who opposeth and exalteth himself above all that is called God, or that is worshipped; so that he as God sitteth in the temple of God shewing himself that he is God.

This is what he will be doing. Wanting you to worship him as God! More documentation Isa 14:13-14; Rev 13:13-15.

2Thes 2:5 Remember ye not, that, when I was yet with you, I told you these things?

Paul telling the Thes, I have told you these things before, **how can you be confused?**

2Thes 2:6 And now ye know what withholdeth that he might be revealed in his time.

Paul telling the Thessalonians, you know the circumstances and the order of events; and you know where to look because it is on the North side of Mt. Zion, God's temple, that satan will appear, as told to you by the prophets of old. ie: the OT.

2Thes 2:7 For the mystery of iniquity doth already work: only he who now letteth will let, until he be taken out of the way.

Who is this "He who not letteth?" And Who is this "He" being taken out of the way? The verb always being the action, therefore, it must transfer back to the subject and object. These are laws of the Greek. In the Greek, "letteth" = Strong's #2722, = katecho = this is a transitive verb ... which means The subject and the object are not in this verse therefore the verb automatically being

transitive transfers it back to verse 4 where the subject is Satan. Where is Satan? Satan is in Heaven; What is he doing there? He is being held there by Michael, Rev 12:7. So we are talking about Michael who now letteth will let, or I like to say kick Satan out of heaven and onto the earth Rev. 12:12 until he be taken out of the way by Christ! But remember it is God who is in control and Michael is doing the will of God.

2Thes2:8 AND THEN shall that Wicked be revealed, whom the Lord shall consume with the spirit of His mouth, and shall destroy with the brightness of His coming:

Now what we are addressing, what is the subject of this chapter? The subject is when is the time of the gathering back, note in this verse how it begins, AND THEN = after the fact of the falling away; After the deception, that God allows to come out upon this world, to those who have not listened to the word of God; Wicked = better translated wicked one, note the caps. Revealed = You will recognize the wicked one, Satan. The Lord = the true messiah; The spirit of his mouth = the two edged sword = the truth God's word, the living word; Brightness = truth, fairness, love,; of his coming = that is our gathering back to Christ at the 7th trump, the last trump.

2Thes 2:8 (KJS) And then shall that Wicked be revealed, whom the Lord shall consume with the spirit of his mouth, and shall destroy with the brightness of his coming: 9 Even him, whose coming is after the working of Satan with all power and signs and lying wonders,

"Even him..." Who is him? What is the last subject spoken about in verse 8? "whom the Lord shall consume with the spirit of His mouth and shall destroy with brightness of His coming: Even Him whose coming is after the working of Satan." The gathering to our Lord Jesus Christ is the subject; "Him" is Christ! Note: did it say before, or in the middle of the tribulation, no it said AFTER THE WORKING OF SATAN shall our Lord Jesus Christ return and destroy that wicked One with the brightness of His coming; after the sixth trump then the seventh trump.....

2Thes 2:10 And with all deceivableness of unrighteousness in them that perish; because they received not the love of the truth, that they might be saved.

You must remember the original manuscripts were not organized with chapters and verse numbers. For clarification we will read verse 9 and 10 together. Note the comma at the end of verse 9. Therefore would have read:

2Thes 2:9&10 Even him (speaking of Christ), whose coming is after the working of Satan (speaking of Satan) with all power and signs and lying wonders, and with all deceivableness of unrighteousness in them that perish; because they received not the love of the truth, that they might be saved.

For it is Satan that is the Father of all lying. Jn 8:44

2Thes 2:11 And for this cause God shall send them strong delusion, that they should believe a lie: This is the purpose I write and give this documentation from God's word so that you can teach the truth in God's word that you may receive the love of his truth. Do not ignore God's word for there is a warning here in 2Thes 2:11 read it again.

Now, lets take a look at in what body we shall be raised, on that last day of men in the flesh, which is the first day of our souls in the spirit on the Lord's Day, which is for a 1000 years and is called the millennium; Turn with me to Paul's writing in 1Cor 15:38-52!

1Cor 15:38 But God giveth it a body as it hath pleased him, and to every seed his own body.

We are here for God's pleasure. (Rev 4:11)

1Cor 15:42 So also is the resurrection of the dead. It is sown in corruption; it is raised in incorruption.

It is through the work of Christ, by his Grace and our faith and witness through repentance that we put on incorruption by the blood of our Lord Jesus Christ.

1Cor 15:44 It is sown a natural body; it is raised a spiritual body. There is a natural body, and there is a spiritual body.

It is raised what? It is raised a spiritual body. Not flesh & bone (without blood) as some suggest but a spiritual (and note) body. The spirit is a body. What happens to flesh and bone Ecc 12:7. For those of you that think we are raised flesh and bone I suggest you go out to the graves and take a look ... the bones are still there today, the spirit is not!

1Cor 15:50 Now this I say, brethren, that flesh and blood cannot inherit the kingdom of God; neither doth corruption inherit incorruption.

There will NOT be flesh ie: corruption in our spiritual bodies. There will be no evil in the one body of Christ.

Eccl 12:7 (KJS) Then shall the dust return to the earth as it was: and the spirit shall return unto God who gave it.

1Cor 5:5 (KJS) To deliver such an one unto Satan for the destruction of the flesh, that the spirit may be saved in the day of the Lord Jesus.

We see here clearly the flesh will be destroyed. That the spirit which is a body will be saved.

1Cor 15:51 Behold, I shew you a mystery; We shall not all sleep, but we shall all be changed,

We shall not all be with Christ asleep when he returns, but we all shall be changed. Note "ALL" shall change from their flesh bodies to their spiritual bodies. When? Next verse!

1Cor 15:52 In a moment, in the twinkling of an eye, at the last trump: for the trumpet shall sound, and the dead shall be raised incorruptible, and we shall be changed.

We = ALL shall be changed from flesh bodies to spiritual bodies at the sounding of the LAST trump. Again there is only one trump to sound announcing our Lord Jesus Christ. Again this is the seventh trump, the last trump! Clearly....The flesh will not be raised. Your spirit shall be raised! So if someone claims to be Jesus and you are still in your flesh body you know they are a liar and a false prophet for it is written we shall be changed at his coming! This is the mystery Paul is showing you!

We know in 1Cor 2:7-8 the prophets speak the hidden wisdom of God.....

1Cor 2:7 But we speak the wisdom of God in a mystery, even the hidden wisdom, which God ordained before the world into our glory:

1Cor 2:8 Which none of the princes of this world knew; for had they known it, they would not have crucified the Lord of glory.

Now that we have studied line by line, let us let God's word speak the hidden wisdom see if you can follow:

2Thes 2:1 Now we beseech you, brethren by the coming of our Lord Jesus Christ, and by our gathering together unto him,

2Thes 2:2 That ye be not soon shaken in mind, or be troubled, neither by spirit, nor by word, nor by letter as from us, as that the day of Christ is at hand.

2Thes 2:3 Let no man deceive you by any means: for that day shall not come except there come a falling away first, and that man of sin be revealed, the son of perdition;

Isaiah:14:13 For thou hast said in thine heart, I will ascend into heaven, I will exalt my throne above the stars of God: I will sit also upon the mount of the congregation, in the sides of the north: 14 I will ascend above the heights of the clouds; I will be like the most High.

Revelation:12:9 And the great dragon was cast out, that old serpent, called the Devil, and Satan, which was cast out into the earth, and his angels were cast out with him.

2Thes 2:4 Who opposeth and exaleth himself above all that is called God, or that is worshipped; so that he as God sitteth in the temple of God shewing himself that he is God.

Revelation:13:13 And he doeth great wonders, so that he maketh fire come down from heaven on the earth in the sight of men, 13:14 And deceiveth them that dwell on the earth by the means of those miracles which he had power to do in the sight of the beast; saying to them that dwell on the earth, that they should make an image to the beast, which had the wound by a sword, and did live.

Rev. 13:8 And all that dwell upon the earth shall worship him, whose names are not written in the book of life of the Lamb slain from the foundation of the world.

Rev 12:12 Therefore rejoice, ye heavens, and ye that dwell in them. Woe to the inhabitants of the earth and of the sea! for the devil is come down unto you, having great wrath, because he knoweth that he hath but a short time.

Matthew 24:21 For then shall be great tribulation, such as was not since the beginning of the world to this time, no, nor ever shall be.

Matt 24:23 Then if any man shall say unto you, Lo, here is Christ, or there; believe it not.

Mark: 13:9 But take heed to yourselves: for they shall deliver you up to councils; and in the synagogues ye shall be beaten: and ye shall be brought before rulers and kings for my sake, for a testimony against them.

Mark 13:11 But when they shall lead you, and deliver you up, take no thought beforehand what ye shall speak, neither do ye premeditate: but whatsoever shall be given you in that hour, that speak ye: for it is not ye that speak, but the Holy Ghost.

Mark 13:12 Now the brother shall betray the brother to death, and the father the son; and children shall rise up against their parents, and shall cause them to be put to death.

Mark 13:20 And except that the Lord had shortened those days, no flesh should be saved: but for the elect's sake, whom he hath chosen, he hath shortened the days.

Matthew: 24:29 IMMEDIATELY AFTER THE TRIBULATION of those days shall the sun be darkened, and the moon shall not give her light, and the stars shall fall from heaven, and the powers of the heavens shall be shaken:

Matt 24:30 "AND THEN" shall appear the sign of the Son of man in heaven: AND THEN shall all the tribes of the earth mourn, and they shall see the Son of man coming in the clouds of heaven with power and great glory.

Revelation: 2:8 And then shall that Wicked be revealed, whom the Lord shall consume with the spirit of his mouth, and shall destroy with the brightness of his coming:

Rev 20:4 And I saw thrones, and they sat upon them, and judgement was given unto them: and I saw the souls of them that were beheaded for the witness of Jesus, and for the word of God, and which had not worshipped the beast, neither his image, neither had received his mark upon their foreheads, or in their hands; and they lived and reigned with Christ a thousand years.

Reve 7:13 (KJS) And one of the elders answered, saying unto me, What are these which are arrayed in white robes? and whence came they? 14 And I said unto him, Sir, thou knowest. And he said to me, These are they which came out of great tribulation, and have washed their robes, and made them white in the blood of the Lamb.

Rev 20:5 But the rest of the dead lived not again until the thousand years were finished. This is the first resurrection.

Mark: 13:17 But woe to them that are with child, and to them that give suck in those days!

There you have it, the word of God speaking, but woe to them that are with child, Satan when He returns.

Let me use a couple verses which symbolizes God's word completely regarding when Christ returns and if you are going to fly away:

First, Matt 13:30 Let both grow together until the harvest: and in the time of harvest I will say to the reapers, Gather ye together first the tares, and bind them in bundles to burn them: but gather the wheat into my barn.

Gather who first? Gather ye together FIRST the tares, the children of the wicked Matt 13:38!

Second, Eph 6:13 Wherefore take unto you the whole armour of God, that ye may be able to withstand in the evil day, and having done all, to stand.

Those that seal themselves in the word of God are they who live and reign with Christ during the Lord's day, (2Pet 3:8) which is a 1000 year period, which is called the millennium. What are they doing there? They are teaching those that are spiritually dead. Why do they get too? Because, they were the ones that were able to stand against deception, in the evil day, the sixth trump, and they did NOT go off flying away, but stood firm against the anti-christ, satan himself! Why? Because they have put on the full armour of God's word, His truth, and the truth always defeats deception!

Reve 9:4 (KJS) And it was commanded them that they should not hurt the grass of the earth, neither any green thing, neither any tree; but only those men which have not the seal of God in their foreheads.

So seal yourselves in his word, remain in the field doing His work, so that you are able to present yourself as a virgin bride to Him. (spiritually speaking!)

Third, Ezek 13:20 Wherefore thus saith the Lord GOD; Behold, I am against your pillows, wherewith ye there hunt the souls to make them fly, and I will tear them from your arms, and will let the souls go, even the souls that ye hunt to make them fly.

Oh yeah, and what was sent out of Noah's ark first the dove or the raven? Correct the raven, and as the days of Noah so shall it be again. Symbolic!

Matt 24:37 (KJS) But as the days of Noe were, so shall also the coming of the Son of man be.

There you have it; God's word documented.

[back to index](#)

Christmas Bible Study

Christmas is a wonderful time of year. Christmas is a very special time for Christians, it is a time of celebration. Just what Christians should be celebrating on Christmas is the real question. I was brought up believing that Christmas was the day that Christ was born. Well the Bible tells us a different story. The Bible tells us that December 25 was the **conception** of Jesus Christ, **not** His birth. Should Christians even celebrate Christmas? Yes, because it is the day that our Lord and Saviour Jesus Christ began to dwell with mankind. To set the time line that December 25 was the conception of Jesus Christ, not His birth, we are going to start with the conception of someone else. We are going to start with John the Baptist. The forerunner to Jesus Christ. For a full Biblical description complete with verse-by-verse commentary, see [E.W. Bullinger's Appendix of the Companion Bible - Dating of the Times](#). It is on this website, and it is definitely worth reading.

Luke 1:1-50

V1 Forasmuch as many have taken in hand to set forth in order a declaration of those things which are most surely believed among us,

The things that happened to Jesus Christ when He was walking the earth were written down for others.

V2 Even as they delivered them unto us, which from the beginning were eyewitnesses, and ministers of the word;

They were eyewitnesses to the events and teachings of Jesus Christ and they help others with what they learned.

V3 It seemed good to me also, having had perfect understanding of all things from the very first, to write unto thee in order, most excellent Theophilus,

Luke being called of God, also had perfect understanding of the works of Jesus Christ, so he wrote them down as well. Theophilus means dear friend of God or dear fellow Christian. Luke also had us in mind when writing this book.

V4 That thou mightest know the certainty of those things, wherein thou hast been instructed.

We will know for sure and will not have to guess about what Luke is telling us.

V5 There was in the days of Herod, the king of Judaea, a certain priest named Zacharias, of the course of Abia: and his wife was of the daughters of Aaron, and her name was Elisabeth.

Zacharias was a descendant of Aaron which means he was a Levite. Elisabeth was also a descendant of Aaron. Zacharias had to be a Levite as well as be married to a Levite to be able to serve as a priest. What this verse also gives us is a date of when this took place. I Chronicles 24:10 tells us that Abia is the eighth course of priests out of twenty four. I Chronicles 24:1-19 will give you a list of the others as well as how they were divided. Now the courses of priest were to serve one week starting each time on the

Sabbath (I Chronicles 9:25 and II Chronicles 23:8). Three times a year all the courses of priests had to serve together. Those times of year were Passover, Pentecost and Feast of Tabernacles (Deuteronomy 16:16). After one of the Great Feasts they would pick up where they left off in the order. The first Jewish month is Nisan which is our April. Passover and Pentecost would happen before Zacharias was to serve his normal course. That would make it the month of Sivan or our June 13-19.

V6 And they were both righteous before God, walking in all the commandments and ordinances of the Lord blameless.

Zacharias and Elisabeth followed the laws of God and fulfilled the duties of a Levitical priest.

V7 And they had no child, because that Elisabeth was barren, and they both were now well stricken in years.

I have no doubt that they were praying for a child as they were getting older. Zacharias also probably wanted a son to take his place so he could retire.

V8 And it came to pass, that while he executed the priest's office before God in the order of his course,

V9 According to the custom of the priest's office, his lot was to burn incense when he went into the temple of the Lord.

Zacharias is on duty and fulfilling his obligations as a priest of the course of Abia. Remember that the time of year is our June 13-19 Zacharias went into the temple of the Lord and only a priest can do that so he was alone. But not for long.

V10 And the whole multitude of the people were praying without at the time of incense.

As Zacharias was burning the incense that went up to our Father, the people prayed. Maybe feeling that they would be better heard at this time.

V11 And there appeared unto him an angel of the Lord standing on the right side of the altar of incense.

V12 And when Zacharias saw him, he was troubled, and fear fell upon him.

Zacharias was minding his own business doing his job when God sent an angel to talk to him. Notice that he was troubled and afraid, scared to death was probably more like it. It makes me laugh when I hear these television preachers say that God spoke to them like it is an everyday kind of thing. To be in the presence of an angel from God or God Himself, is not something that our flesh can adjust to quickly. Jacob was scared by a dream from God (Genesis 28:10-22) and Zacharias is not doing much better with the angel from God. Both of those men were chosen by our Father to do His will and did not take it lightly when He spoke to them. Now I'm not talking about the Holy Spirit as that has a totally different affect on us. When the Holy Spirit touches our soul, it makes us feel warm and gives us comfort. Notice also that the angel stood on the right side of the altar. Which side did Christ say to fish from? The right side (John 21:5-6). Just some food for thought for people who vote.

V13 But the angel said unto him, Fear not, Zacharias: for thy prayer is heard; and thy wife Elisabeth shall bear thee a son, and thou shalt call his name John.

The angel told Zacharias to relax and not to be afraid. John was given his name by God and it means Yehovah is a gracious giver.

V14 And thou shalt have joy and gladness; and many shall rejoice at his birth.

V15 For he shall be great in the sight of the Lord, and shall drink neither wine nor strong drink; and he shall be filled with the Holy Ghost, even from his mother's womb.

Even before John is born of woman, he will be filled with the Holy Spirit. He will be great in the eyes of God because he is the forerunner to Christ and will turn many hearts to Jesus Christ. The reason Luke is telling us all this is so that we will know the date of the conception and birth of John as well as Christ.

V16 And many of the children of Israel shall he turn to the Lord their God.

V17 And he shall go before Him in the spirit and power of Elias, to turn the hearts of the fathers to the children, and the disobedient to the wisdom of the just; to make ready a people prepared for the Lord.

John would be the one in the wilderness saying "Prepare ye the way of the Lord, make His paths straight." John came in the spirit of Elijah but he was not Elijah, they are not the same person. John just had the same type of spirit that Elijah did in the eyes of the Lord. The just is Jesus Christ.

V18 And Zacharias said unto the angel, Whereby shall I know this? for I am an old man, and my wife well stricken in years.

Zacharias not only lost the fear he had but now he is even doubting what the angel is saying. He is saying "My wife and I are to old for this to happen, how can this be?" He is looking for a sign now.

V19 And the angel answering said unto him, I am Gabriel, that stand in the presence of God; and am sent to speak unto thee, and to shew thee these glad tidings.

Gabriel means mighty man of God. He is the archangel that stands in the presence of God. He tells Zacharias that he was sent by God to tell him these things. The fear is probably coming back to Zacharias now.

V20 And, behold, thou shalt be dumb, and not able to speak, until the day that these things shall be performed, because thou believest not my words, which shall be fulfilled in their season.

He asked for a sign and he got one. He will not be able to speak again until these things happen just like Gabriel said they would. Be careful when you ask for a sign because you just might get one and not be happy when you do. Zacharias said his last words for nine months. He will not be able to speak again until John is born (Luke 1:57-64).

V21 And the people waited for Zacharias, and marveled that he tarried so long in the temple.

The people were getting restless because he was gone longer than normal.

V22 And when he came out, he could not speak unto them: and they perceived that he had seen a vision in the temple: for he beckoned unto them, and remained speechless.

Gabriel was true to his word. If Gabriel ever appears to you, don't challenge him.

V23 And it came to pass, that, as soon as the days of his ministration were accomplished, he departed to his own house.

Zacharias had to serve to the 19th of June so he left on the 20th. His house was about 30 miles from Jerusalem so at his age it would take him about 2 days to get home. When he got home he probably rested some and the conception of John would happen on June 23rd or 24th.

V24 And after those days his wife Elisabeth conceived, and hid herself five months, saying,

V25 Thus hath the Lord dealt with me in the days wherein He looked on me, to take away my reproach among men.

Elisabeth conceived just like Gabriel told Zacharias she would. She hid for 5 months so that brings us to November 24th.

V26 And in the sixth month the angel Gabriel was sent from God unto a city of Galilee, named Nazareth,

Gabriel is back six months after talking to Zacharias. Elisabeth has been pregnant with John for six months now which brings us to December 25th.

V27 To a virgin espoused to a man whose name was Joseph, of the house of David; and the virgin's name was Mary.

Espoused means to be promised in marriage, to be betrothed. Joseph was a relative of king David which means he was from the house of Judah.

V28 And the angel came in unto her, and said, Hail, thou that art highly favoured, the Lord is with thee: blessed art thou among women.

Hail means to be cheerful. The angel is telling Mary that she has found a whole bunch of grace in the eyes of God. She also has been blessed as she is the mother of our Saviour Jesus Christ.

V29 And when she saw him, she was troubled at his saying, and cast in her mind what manner of salutation this should be.

Mary is thinking to herself 'What in the world is he talking about?' It's not like people said this kind of stuff to her all the time. A little bit of fear is entering her mind.

V30 And the angel said unto her, Fear not, Mary: for thou hast found favour with God.

Gabriel is telling Mary not to fear, that she received grace from God.

V31 And, behold, thou shalt conceive in thy womb, and bring forth a Son, and shalt call His name JESUS.

V32 He shall be great, and shall be called the Son of the Highest: and the Lord God shall give unto Him the throne of His father David:

V33 And He shall reign over the house of Jacob for ever; and of His kingdom there shall be no end.

Jesus was named by God and it means Salvation of Yehovah. This is God's way of bring salvation into this world. Jesus Christ was God in the flesh here to die on the cross for our sins. That's love. Note also the four statements of the angel covers the four different ways the Lord is presented in the Gospels.

1.) Thou shalt conceive in thy womb, and bring forth a Son: "Behold the Man Whose name is The BRANCH" From Zechariah 6:12 The Lord is presented as God's ideal Man in Luke. The human genealogy is given all the way back to Adam. Luke 3:23-38

2.) Thou shalt call His name Jesus: "Behold My Servant" From Isaiah 42:1 The Lord is presented as God's ideal Servant in Mark. No genealogy is required.

3.) He shall be great, and shall be called the Son of the Highest: "Behold your God!" From Isaiah 40:9 The Lord is presented as God Himself and Divine in John. No genealogy is required.

4.) He shall reign over the house of Jacob for ever; and of His kingdom there shall be no end. "Behold thy King" From Zechariah 9:9 The Lord is presented as God's King for mankind in Matthew. The royal genealogy is given in Matthew 1:1-16

V34 Then said Mary unto the angel, How shall this be, seeing I know not a man?

Mary is wondering how can this happen seeing that she never has been with a man. Mary is showing her faith by not questioning that it can happen but just wondering how it will happen.

V35 And the angel answered and said unto her, The Holy Ghost shall come upon thee, and the power of the Highest shall overshadow thee: therefore also that holy Thing Which shall be born of thee shall be called the Son of God.

Overshadow means to cast a shade upon, i.e. (by analogy) to envelope in a haze of brilliancy; figuratively, to invest with preternatural influence. We are told how the conception of our Lord and Saviour Jesus Christ happened.

V36 And, behold, thy cousin Elisabeth, she hath also conceived a son in her old age: and this is the sixth month with her, who was called barren.

We are told again that Elisabeth has been pregnant with John for six months now. That is important to fix the date here, which is December the 25th as the conception of Christ, not His birth.

V37 For with God nothing shall be impossible.

What a wonderful statement about our Father! What we think is impossible is not a problem for God. He is able to do anything He wants at anytime.

V38 And Mary said, Behold the handmaid of the Lord; be it unto me according to thy word. And the angel departed from her.

I think it's just wonderful that Mary had such faith and trust in what the angel told her. The same can't be said about Zacharias. You can score the faith in this story: Women 1 Men 0 So the angel leaves Mary and the conception of the Son of God takes place on December the 25th.

V39 And Mary arose in those days, and went into the hill country with haste, into a city of Juda;

V40 And entered into the house of Zacharias, and saluted Elisabeth.

Mary runs to see her cousin Elisabeth to share the great news. This shows more faith on Mary's part as she wants to share in the news of Elisabeth's conception, that the angel told her about in V36.

V41 And it came to pass, that, when Elisabeth heard the salutation of Mary, the babe leaped in her womb; and Elisabeth was filled with the Holy Ghost:

V42 And she spake out with a loud voice, and said, Blessed art thou among women, and blessed is the fruit of thy womb.

V43 And whence is this to me, that the mother of my Lord should come to me?

V44 For, lo, as soon as the voice of thy salutation sounded in mine ears, the babe leaped in my womb for joy.

V45 And blessed is she that believed: for there shall be a performance of those things which were told her from the Lord.

The Holy Spirit gave Elisabeth knowledge that Mary is the mother of our Lord and Saviour. Elisabeth was also being humble in verse 43 when she asked why the mother of the Lord should come and see her. The Spirit of our Lord was so strong inside Mary's womb, that John being in Elisabeth's womb for six months, jumped for joy.

V46 And Mary said, My soul doth magnify the Lord,

V47 And my spirit hath rejoiced in God my Saviour.

V48 For He hath regarded the low estate of His handmaiden: for, behold, from henceforth all generations shall call me blessed.

V49 For He That is mighty hath done to me great things; and holy is His name.

V50 And His mercy is on them that fear Him from generation to generation.

Some wonderful words from the mother of our Saviour, Jesus Christ. The word fear means to frighten, i.e. (passively) to be alarmed; by analogy, to be in awe of, i.e. revere. Now God really does not want us to be afraid of Him. After all, He did have His only begotten Son die on the cross for our sins, so He loves us a whole bunch. What He does want from us is our love for Him and Christ. God wants us to have a feeling of deep respect and awe for Him.

A recap of the dates of conception and birth

Event -	Conception of John	Birth of John	Begetting of Christ	Nativity or birth of Christ

Jewish month -	23rd Sivan	7th Nisan	1st Tebeth	15th Tisri
English month -	June 23rd or 24th	March 28th or 29th	December 25th	September 29th

Now should Christians even celebrate Christmas? Yes - because it is a wonderful time of year for us. It is the day on which Christ began to dwell with mankind. Our Lord and Saviour to take away our sins. Just remember that it is the day of His conception not His birth and it will be ok. Tell your children the truth and enjoy this special time of year.

[back to index](#)

Gentiles and Jews: It's time for understanding.

Two of the most confusing words in The Bible for modern readers are Gentiles and Jews. These words can be a block over which many stumble; since most will not bother to actually research these terms, there is great confusion over their actual use and meaning.

Gentiles

This section will cover the Hebrew words *goi* (singular) and *goyim* (plural), as they are used in The Old Testament, and the Greek words *ethnos* (singular) and *ethne* (plural), as used in The New Testament. The Hebrew word *goi* appears over 550 times in the Old Testament, while the Greek word *ethnos* appears over 160 times in the New Testament. The Hebrew word *goi* and the Greek word *ethnos* have been translated nations more than any other word. The word *gentile* comes from the Latin word *gentilis* and means a clan, a race, and can either be your own clan or race, or can be applied to a foreigner. Ecclesiastically it was used in the past to signify pagans or heathens. The Following verses show the terms *goi* and *ethnos* in reference to Israel and the Judeans.

Goi

Gen. 12:2: I will make of thee a great nation.

Gen. 17:4,5: A father of many nations have I made thee.

Gen. 20:1: Lord, wilt thou slay a righteous nation?

Gen. 25:23: Two nations are in thy womb.

Gen. 35:11: A nation and a company of nations.

Gen. 48:19: Thy seed shall become a multitude of nations.

Isa. 1:4: Ah sinful nation, a people laden with iniquity.

Isa. 10:6: Send him against an hypocritical nation.

Jer. 31:36: Shall cease from being a nation before me.

Ethnos

Luke 7:5: He loveth our nation and hath built us a synagogue.

John 11:48: The Romans will come and take our place and nation.

Acts 24:2: Worthy deeds are done unto this nation by the providence.

Acts 24:17: I came to bring alms to my nation.

These verses show the terms *goi* and *ethnos* used to describe Non-Israelites. In these New Testament verses, the term *ethnos* is translated as gentiles, nations, and people.

Goi

Gen. 14:9: With Chedorlaomer the king of Elam, and with Tidal king of nations.

Gen. 21:13: And also the son of the bond woman will I make a nation.

Gen. 21:18: For I will make of him a great nation.

Ex. 9:21: ...There was none like it in all the land of Egypt since it became a nation.

Ex. 34:24: ...For I will cast out the nations before thee.

Isa. 37:12: Have the gods of the nations delivered them which my.....

Ethnos

Matt. 10:5: Go not in the way of the gentiles.

Matt. 24:7: For nation shall rise against nation.

Luke 21:24: ...by the edge of the sword, and shall be led away captive into all nations.

Acts 7:7: And the nation to whom they shall be in bondage will I judge, said God.

Acts 8:9: ... the same city used sorcery, and bewitched the people of Samaria.

Acts 10:45: ... Because that on the Gentiles also was poured out the gifts

Gen. 22:18: And in thy seed shall all the nations of the earth be blessed.

Gen. 25:23: Two nations are in thy womb.

I Chron. 16:23,24: Declare his glory among the heathen...his marvelous works among the nations.

Psa. 9:19,20 : ...Let the 'heathen' be judged in thy sight. Put them in fear, oh Lord; that the nations may know themselves to be but men.

These last two verses have the words *heathen* and *nations* translated from the same word in the same passage!

Matt. 24:9,14 "...and ye shall be hated of all nations for my name's sake," "This gospel of the kingdom shall be preached for a witness to all nations.

Matt. 28:19 Go ye therefore and teach all nations.

Acts. 10:35 But in every nation he that feareth him, and worketh righteousness, is accepted with him.

The Greek word Hellen is even translated as Gentiles 27 times in the New Testament, when in fact it actually means Greeks!

Hebrew Definitions

Jew

3064 Yehuwdiy : yeh-hoo-dee'; patron. from # 3063 ; a Jehudite (i.e. Judaite or Jew), or desc. of Jehuda (i.e. Judah):-Jew.

3063 Yehuwdah : yeh-hoo-daw'; from # 3064 ; celebrated; Jehudah (or Judah), the name of five Isr.; also of the tribe descended from the first, and of it's territoy.

3034 Yadah : yaw-daw'; a prim. root; used only as denom. from # 3027; lit. to use (i.e. holdout) the hand; phys. to throw (a stone, an arrow) at or away; espec. to reverse or worship (with extended hands):-cast (out), (make) confess (-ion), praise, shoot, (give) thank (-ful, -s, -s giving).

3027 Yad : yawd; a prim. word; a hand (the open one [indicating power, means, dircetion, etc.], in distinction from # 3079, the closed one); used (as noun, adv., etc.) in a great variety of applications, both lit. and fig., both proximate and remote [as follow]:-(+ be) able, X about, + armholes, at, axletree, because of, beside, border, X bounty, + broad, [broken-] handed, X by, charge, coast, + consecrate, + creditor, custody, debt, dominion, X enough, + fellowship, force, X from, hand [-staves,-y work], X he, himself, X in, labour, + large, ledge, [left-] handed, means, X mine, ministry, near, X of, X order, ordinance, X our, parts, pain, power, X presumptuously, service, side, sore, state, stay, draw with strength, stroke, + swear, terror, X thee, X by them, X themselves, X thine own, X thou, through, X throwing, + thumb, times, X to, X under, X us, X wait on, [way-] side, where, + wide, X with (him, me, you), work, + yield, X yourselves.

Jewry

3061 Yehuwd : (Chald.) yeh-hood'; contr. from a form corresp. to # 3063; prop. Judah, hence Judea:-Jewry, Judah, Judea.

Jews

3062 Yehuwdaiy : yeh-hoo-daw-ee'; partial from # 3061; a Jehudaite (or Judaite), i.e. Jew:- Jew.

3054 Yahad : yaw-had'; denom. from a form corresp. to # 3061; to Judaize, i.e. become Jewish:- become Jews.

Jews'

3066 Yehuwdiyth : yeh-hoo-deeth'; fem of # 3064; the Jewish (used adv.) language:- in the Jews' language.

Greek with The Hebrew Root.

1. Jew (# 2448).

3194 Yuttah : yoot-taw'; or Yuwtah : yoo-taw'; from # 5186; extended; Juttah (or Jutah), a place in Pal.:- Juttah.

5186 Natah : naw-taw'; a prim. root; to stretch or spread out; by impl. to bend away (includ. mor. deflection; used in a great variety of application (as follows):- + afternoon, apply, bow (down, -ing), carry aside, decline, deliver, extend, go down, be gone, incline, intend, lay, let down, offer, outstretched, overthrown, pervert, pitch, prolong, put away, shew, spread (out), stretch (forth, out), take (aside), turn (aside, away), wrest, cause to yield.

2453 loudaios : ee-oo-dah'-yos; from # 2448 (in the sense of # 2455 as a country); Judean, i.e. belonging to Jehudah;- Jew (-

ess), of Judea.

2448 louda : ee-oo-dah'; of Heb. or. [# 3063 or perh. # 3194]; Judah (i.e. Jehudah or Juttah), a part of (or place in) Pal.: - Judah.

2455 loudas : ee-oo-das'; of Heb. or.[# 3063]; Judas (i.e. Jehudah), the name of ten Isr.; also of the psoterity of one of them and it's region:-Juda(-h, -s); Jude.

2. Jewess (# 2453)

3. Jewish

4. Jewry

2451 loudaikos : ee-oo-dah-ee-kos'; from # 2453; Judaic, i.e. resembling a Judean:- Jewish.

2449 loudaia : ee-oo-dah'-yah'; fem. of # 2453(with #1093 impl.); the Judean land (i.e. Judea), a region of Pal:- Judea .

1093 Ge : ghay; contr. from a prim. word; soil; by extens. a region, or solid part or the whole of the terreneglobe (includ. the occupants in each application):- country, earth (-ly), ground, land, world.

5. Jews.

2450 loudaizo : ee-oo-dah-id'-zo'; from # 2453; to become a Judean, i.e. "Judaize:- live as the Jews.

2452 loudaikos : ee-oo-dah-ee-koce'; adv. from # 2051; Judaically or in a manner resembling a Judean:- as do the Jews.

6. Jews'.

2454 loudaismos : ee-oo-dah-is-mos'; from # 2450; "Judaism", i.e. the Jewish faith and usages:- Jews' religion.

7. Judea (# 2449 and # 2453).

[back to index](#)

[Back to Christian Links webpage](#)

[SITE INDEX](#)

[The Shepherd's Chapel,](#)
[Pastor Arnold Murray](#)

[\[Christian Links\]](#)



All God's Children

"The Mystery of the Wheat and Tares"

As children of God, we are called to serve Him, and in our love for Him, we desire to grow closer to the Lord. We did not choose Him first; instead, He chose us. We were created for His pleasure (Rev. 4:11). Because the Lord loves us, He has written to us in his word of what will happen, and why these things happen. There are no unanswered questions in this world, only mysteries to solve. The events recorded in scripture are for our benefit. If we will study the scriptures with wisdom, the most difficult questions will be answered.

The Bible is basically a story of one man's family, and those people who come in contact with them. Our Father, God, in His great love for us, has given us warning to protect us, much as we try to warn and protect our loved ones. The children of Cain are part of a hidden mystery. As we enter these final days before the millennium, many amazing things will happen in the physical realm revealing the spiritual world. The Holy scriptures are our instruction of how to be wise in these perilous times.

All verses quoted are from the **King James Version of the Bible**. Every word in this bible can be translated to its original meaning in the Hebrew, Chaldea or Greek with a **Strong's Concordance**. Every serious student of God's word should have this tool. It is simple to use and the information gleaned is priceless. When reading the King James Bible and you find a word you want to check in its original usage, just note the book, chapter, and were that word comes from and look in the **Strong's Concordance**. Look up the word as you would in a dictionary.

Example: Genesis 6:9 "These are the generations of Noah: Noah was a just man and Perfect in his generations, and Noah walked with God."

generations is # 8435 towledah: descent of family

Perfect is # 8549 Tamim: without blemish, undefiled; pedigree

So, from this verse it is clear that we are about to read of a man called Noah. His family had not mixed their race (pure pedigree) with the fallen angels and he served God. Noah was a good man, but his pure pedigree is what God saw that separated his family from the others in his region. The scriptures concerning the first recorded birth and his family are equally interesting. Let's discover the hidden mystery of Cain and his children, the Kenites.

Cain #7014 Qayin, kah-yin; the name of the first child, also of a place in Pal.; and of an oriental tribe; Cain, Kenite(s).

Kenite #7017 Qiyiniy ,kee nee'; patron 7014; a Kenite or member of the tribe of Kayin/Cain: -- Kenite.

The name translates to meaning a sense of fixity as striking fast in terms of a lance or spear (see #7013). What do we know of Cain? Genesis 4 tells us of the birth and life of Cain. First, fraternal twin brothers. Genesis 4:1-2:

4:1 And Adam knew Eve his wife; and she conceived, and bare Cain, and said, I have gotten a man from the LORD. 4:2 And she again bare his brother Abel. And Abel was a keeper of sheep, but Cain was a tiller of the ground.

The word "again" in Vs 2 is:

#3254 Yacaph, yaw-saf; a prime root; to add or augment (often adv. to continue to do a thing).

***note #5750 Owd, ode; from 5749; prop. iteration or continue; used only adv. (with or without prep) again, repeatedly, still, more;-- again, all life long, at all, besides, but, else, further.**

This word Owd which seems to mean the same as Yacaph is used to demonstrate separate births not twin births in Gen 4:25, 29:33-45, 38:4&5, and it is used to exhibit a repeat of a prior action in verses Gen 35:9, Deu 13:16, Jdg 13:8, 20:25, Ru 1:14. It validates the idea of Yacaph as being unique in continuing an action. God says what he means in the bible and He chose the word yacaph for the birth of Cain and Abel.

The obvious meaning is **Eve gave birth to Cain then continued to labor and bore Abel.** There is more telling evidence of their being twins in that they both came of age to sacrifice to the Lord at the same time, see Gen 4:3-4:

4:3 And in process of time it came to pass, that Cain brought of the fruit of the ground an offering unto the LORD. 4:4 And Abel, he also brought of the firstlings of his flock and of the fat thereof. And the LORD had respect unto Abel and to his offering:

"In the process of time..." is better read in the Hebrew as "at [the] end of days" giving as appointed season for sacrifice, thus Cain and Abel came of age at the same appointed season.

What can we say of Cain's offerings?

Cain could have brought first fruits, but he did not. He brought fruit, while Abel brought the firstlings of his flock along with their fat (as we know the fat is the Lord's Lev. 1:16).

Fruit #6529 Periy, per-ee; from 6509, fruit, bough, reward.

Firstlings #1062 Behowrah, bek-o-raw; or (short form) beforah, bek-o-raw; fem. of 1060; the firstling of man or beast; abstract ; primogenitive:--birthright, firstborn(ling).

Firstfruits are considered ones best as there will never be another to come first. Abel gave his best to the Lord, while Cain just gave out of some "religious" obligation. God respected Abel's offering. What is a sign of the Lord's accepting an offering? Well, in Lev. 9:24 the offering is consumed by fire sent divinely from God. Other examples of the divine fire from God are found in Jud 6:21, 1Ki 18:38, 1Chr 21:26, 2Chr 7:1, and the witness of this divine fire for Abel in Hebrews:

Hebrews 11:4 By faith Abel offered unto God a more excellent sacrifice than Cain, by which he obtained witness that he was righteous, God testifying of his gifts: and by it he being dead yet speaketh.

What does Hebrews 11:4 mean? Abel believed God was worthy of offerings so by this faith he brought only the best to his God which was better than Cain brought. The implication being that Cain did not believe God was worthy of the gifts/offering. Because Abel did this act of faith he obtained a witness from God that he, Abel, was righteous. This divine fire showed God approved of Abel and not Cain. The word "testifying" in the Greek is:

#3140 Martureo, mar-too-ree'-o, from 3144, to be a witness, i.e. testify: charge, give [evidence], bear record, have (obtain, of) good (honest) report.

God sends a physical manifestation for Abel to know he was approved and for Cain to know he was not approved of by God. Cain sees his offering shunned and Abel's divinely accepted. Rather than repenting for his sin and correcting his failure, Cain is filled with rage and jealousy over Abel, and one might add God. Cain kills Abel, possibly a symbolic act of killing God, and he leaves Abel's body in a field.

God knows what has happened and seeks Cain to answer for his crime of murder. God punishes Cain with a curse of not being able to farm ever again, neither him nor his children. Cain sees this as a death sentence (Gen. 4:14).

4:14 Behold, thou hast driven me out this day from the face of the earth; and from thy face shall I be hid; and I shall be a fugitive and a vagabond in the earth; and it shall come to pass, that every one that findeth me shall slay me.

It is interesting to note God did not take Cain's life as the penalty for murder is death, but the law had not yet been given. Instead, God curses Cain and his offspring (evident in future verses) to never yield fruit from the ground. God also places a mark upon Cain to keep him and his children safe from murder. I will not go into the mark yet, but there are clues available in scripture to recognize a Kenite. One or the more obvious clues is revealed in the children of Cain in Gen. 4:17-24:

4:17 And Cain knew his wife; and she conceived, and bare Enoch: and he builded a city, and called the name of the city, after the name of his son, Enoch.4:18 And unto Enoch was born Irad: and Irad begat Mehujael: and Mehujael begat Methusael: and Methusael begat Lamech.4:19 And Lamech took unto him two wives: the name of the one was Adah, and the name of the other Zillah.4:20 And Adah bare Jabal: he was the father of such as dwell in tents, and of such as have cattle.4:21 And his brother's name was Jubal: he was the father of all such as handle the harp and organ. 4:22 And Zillah, she also bare Tubalcain, an instructor of every artificer in brass and iron: and the sister of Tubalcain was Naamah. 4:23 And Lamech said unto his wives, Adah and Zillah, Hear my voice; ye wives of Lamech, hearken unto my speech: for I have slain a man to my wounding, and a young man to my hurt. 4:24 If Cain shall be avenged sevenfold, truly Lamech seventy and sevenfold.

There is a great deal of information to be gleaned from this passage. First, Cain took a wife from the land of Nod. This woman is not in the listing as one of Adam's children.

Who is Cain's wife?

Obviously, God created men and women on the sixth day who were of all races. They were to be hunters and fishers. God then rested and saw there was no one to till the ground for agriculture. God then created The Adam Genesis 1:26-28:

1:26 And God said, Let us make man in our image, after our likeness: and let them have dominion over the fish of the sea, and over the fowl of the air, and over the cattle, and over all the earth, and over every creeping thing that creepeth upon the earth. 1:27 So God created man in his own image, in the image of God created he him; male and female created he them. 1:28 And God blessed them, and God said unto them, Be fruitful, and multiply, and replenish the earth, and subdue it: and have dominion over the fish of the sea, and over the fowl of the air, and over every living thing that moveth upon the earth.

We first notice that God said, "let us make man in our image. The word man has no article in the Hebrew and thus is a term for mankind in general, not a specific man.

#120 Adam, aw-dawm'; a human being, person.

It is interesting to note that God told these people to replenish the earth. In order to replenish the earth it must have been inhabited before this new earth was created. Gen. 1:2 states the earth was without form and void, but the Hebrew states clearly that the Earth became without form and void. The word was in Hebrew is became not a state of creation.

1:31 And God saw every thing that he had made, and, behold, it was very good. And the evening and the morning were the sixth day.

God is pleased with everything He has done and it is good. God rested on the seventh day and when the eighth day began He sees there is no man to till the ground. Now, God does not make mistakes, and a study of biblical numerics makes this an interesting situation. God knew

what the plan for mankind was and He knew how the events would play out. The number 8 symbolizes new beginnings. When you come to salvation in Messiah Yeshua/Jesus you are a new creature/person. It makes perfect sense that God chose a man/race to bring the Messiah into the world and that man was "THE ADAM". Gen 2:7

2:7 And the LORD God formed man of the dust of the ground, and breathed into his nostrils the breath of life; and man became a living soul.

This word "man" is given with an article in Hebrew to denote a specific man. It reads "eth-Ha Adham or THE ADAM. Now, this may seem to some that The Adam is better or superior, but that is only for the biblically illiterate to reason. God chose a race to bring Messiah into the world through, and that race is the ruddy complected children of THE ADAM. All races were created by God perfect and beautiful. God stated such when he completed the work on the sixth day. Cain took a wife from the sixth day creation. It is to the discredit of The Adam and Eve that they fell into sin so easily. Satan was after Eve immediately, and no wonder, the greatest threat to him was coming through this couples children.

The Mother of All Living

Eve is called the mother of all living because of who Messiah is. It is through the children of Eve that we finally come to the tribe of Judah and the young maiden, Miriam/Mary to receive the Holy conception where no man had a part. Once you come to salvation in Messiah Yeshua/Jesus you have eternal life, and the fear of death has no hold on you. Thus in Messiah down through the generations to Eve she is the mother of all living being the beginning of the seed line for Messiah.

Kenites the Sons of Cain

What do the names and occupations of Cain's children reveal? Genesis 4:17-24 shows us that none are farmers. Also, at the end of several names we have the lesser form of the name of God "el" which can also mean a god. Not as respectful as the "ah" ending in Adams lineage for the high name of God "Yah".

Enoch - teaching or initiation

Irad - city of witness

Mehujael - smitten of God, abolish, blot out, destroyed by almighty

Methusael - man who is of God or god

Lamech - powerful

Adah - ornament

Zillah - Defense, shade or shadow

Jabel - flowing

Jubal - joyful sound

Tubal Cain - flowing from Cain

Naaman - Pleasantness

As Cain viewed it his right to kill Abel for offending him, Lamech sees it is his right to kill anyone who hurts or offends him, and the protection given Cain will be magnified to seventy-seven fold. Does this remind you of a certain New Testament passage where we are told to forgive people seventy-seven fold? The exact opposite of a Kenite philosophy!

So, what do we know about the Kenites? They have bad tempers and seem self indulgent. None of them are farmers. They have one child per family except for Lamech whose name means powerful. He has two wives to show his power and strength and each of them has two children. I believe the women both had twins thus adding to the image of power, not by will mind you, just the way it worked out. Another clue about Kenites is they mimic the children of God. In Genesis chapter 5 we are given the genealogy of the children of Adam. Notice also that this genealogy is given as the children of Adam, and Cain is not even mentioned.

Cain is not Adam's Son

Why is Cain not even given a place as being the bad son? There is a teaching that the lineage of Adam is to show the Messiah's line, but this is not written in the scripture. It would have been easy to write Adam knew Eve and she bore Cain and Abel. Cain slew Abel. Cain slew Abel before children were born to them. Adam knew Eve again and she bore Seth and other sons and daughters. The scriptures do not say this. Let's read the passage Genesis 5:1-5:

5:1 This is the book of the generations of Adam. In the day that God created man, in the likeness of God made he him;5:2 Male and female created he them; and blessed them, and called their name Adam, in the day when they were created.5:3 And Adam lived an hundred and thirty years, and begat a son in his own likeness, and after his image; and called his name Seth: 5:4 And the days of Adam after he had begotten Seth were eight hundred years: and he begat sons and daughters: 5:5 And all the days that Adam lived were nine hundred and thirty years: and he died.

*(note: a side study for the atheists who like to study the bible for error and "lies", they say "see, Adam did not die the day he sinned in the garden, thus the bible is a lie!" Well, Adam lived 930 years. A day unto the Lord is as a thousand years, so Adam died 70 years before the Day was over in God's estimation of time. Reference Psalm 90:4 and 2 Pe 3:8)

Where is Cain in Adam's own likeness and image? He is not listed because he is not Adam's

son! Now, before you get angry and throw away this study, let's go see in scripture the proof of whose son he is AND what did Yeshua/Jesus say regarding Cain and his children the Kenites.

Things hidden from the foundation

Yeshua taught in parables for those with eyes to see and ears to hear to learn the mysteries of the Kingdom of God. Matthew: 13:35 That it might be fulfilled which was spoken by the prophet, saying, I will open my mouth in parables; I will utter things which have been kept secret from the foundation of the world.

Do you know what it means to be kept secret? Proverbs says:

25:2 It is the glory of God to conceal a matter and the glory of Kings to search out a matter.

Many people refuse to dig in the word of God and discover the "secrets" it contains. What does the phrase in Matthew 13:35 "from the foundation of the world" mean?

Foundations is #2602 Katabole', kat-ab-ol-ay; from 2598; a deposition, i.e. founding; fig. conception

#2598 Katallo, kat-ab-al'-lo, to throw down--cast down, descend, fall.

Something has been hidden from the fall of the first earth age. What caused the destruction of that age? Why did God destroy the first earth and heaven age? Because Satan, the covering cherub (Ez 28:14) rose up to be worshipped as God and a third of the sons of God followed Satan (Rev. 12:4). Instead of destroying them all, God destroyed that earth and heaven age. There was great destruction, so vast and complete that nothing on earth survived it.

Jeremiah 4:23-28 reads

I beheld the earth, and, lo, it was without form, and void; and the heavens, and they had no light. 4:24 I beheld the mountains, and, lo, they trembled, and all the hills moved lightly. 4:25 I beheld, and, lo, there was no man, and all the birds of the heavens were fled. 4:26 I beheld, and, lo, the fruitful place was a wilderness, and all the cities thereof were broken down at the presence of the LORD, and by his fierce anger. 4:27 For thus hath the LORD said, The whole land shall be desolate; yet will I not make a full end. 4:28 For this shall the earth mourn, and the heavens above be black; because I have spoken it, I have purposed it, and will not repent, neither will I turn back from it.

"Was without form and void" means in the Hebrew the earth became destroyed, just as Genesis 1:2 states. This passage is telling how it was destroyed. The word "was" is became in the Hebrew.

#1961 hayah, to become

God destroyed everything! Not a plant, animal, building survived this destruction. Mammoths are discovered with buttercups still in their mouths in the North Tundra where only ice and snow are today. This was a swift and sudden destruction. Many misunderstand this passage and assume it is referring to Noah's flood, but we know at least eight Adamic souls survived, many animals and plants made it. It takes about a hundred years to grow an olive tree to bear fruit and leaves. It is one of the slowest growing of all trees. Yet, with Noah's flood the dove brings an olive tree branch to the ark as a symbol of life and peace. Can you sense the massive catastrophe expressed by the writer who repeats "I beheld, and lo", as a feeling of absolute destruction. When God moves it is decisive and quick.

Yeshua said in Mt 13:35 he would utter things kept secret from the foundation of the world. After that great destruction, God created a new heaven and earth. He created the world we live in today. And, as quickly as He created this world, Satan tried to overthrow it as well.

Parable of the Wheat and Tares

Yeshua spoke this parable in Matthew 13

13:24 Another parable put he forth unto them, saying, The kingdom of heaven is likened unto a man which sowed good seed in his field: 13:25 But while men slept, his enemy came and sowed tares among the wheat, and went his way. 13:26 But when the blade was sprung up, and brought forth fruit, then appeared the tares also. 13:27 So the servants of the householder came and said unto him, Sir, didst not thou sow good seed in thy field? from whence then hath it tares? 13:28 He said unto them, An enemy hath done this. The servants said unto him, Wilt thou then that we go and gather them up? 13:29 But he said, Nay; lest while ye gather up the tares, ye root up also the wheat with them. 13:30 Let both grow together until the harvest: and in the time of harvest I will say to the reapers, Gather ye together first the tares, and bind them in bundles to burn them: but gather the wheat into my barn.

The disciples came to Yeshua and asked for an explanation of this parable. Yeshua told us of this mystery in Matthew 13:37:

He answered and said unto them, He that soweth the good seed is the Son of man; 13:38 The field is the world; the good seed are the children of the kingdom; but the tares are the children of the wicked one; 13:39 The enemy that sowed them is the devil; the harvest is the end of the world; and the reapers are the angels. 13:40 As therefore the tares are gathered and burned in the fire; so shall it be in the end of this world.

The parable is so simple, but many refuse to see or do not have eyes to see. Who is God's enemy? Satan is the enemy of God. What are children? Well, now that is a tough one. Children are the creation of God in Genesis. The Greek is even cleared in understanding.

Seed #4690 Sperma, sper'-mah, from 4687, something sown, i.e. seed

This is the same word from which we get our English term, sperm. What else does this parable

tell us about God's children verses Satan's children? The use of the term wheat and Tares is very important. Wheat is the foundation for bread. God sowed bread, the bread of life is Yeshua. Yeshua is the word made flesh, and the word is likened to bread as well. Through faith in Him all have access to God the Father. What are tares? They are look alike weeds to wheat. In Greek:

#2215 Zizanion, dziz-an'-ee-on; of uncert origin; darnel or false grain- tares.

These look weeds look just like wheat in the beginning, then as it becomes time to bear fruit they turn black and are good for nothing except kindling in a fire. It is as if God created these weeds just to give us this picture of Kenites and Adam's children. The whole parable is about the foundation mystery, thus these are the children from the beginning of this earth age--Cain and Abel whom Cain slew, then to Seth to carry on the line.

When would we see the harvest? At the end of the "world". This word in Greek is:

#165 Aion, ahee-ohn; from the sense of 104, prop. an age.

We will have the harvest at the end of this age. The last days began in 1948 when Israel became a nation. and a benchmark in time happened in 1968 when Jerusalem was no longer in the hands of gentiles. Luke 21:24 gives us the biblical timetable to see when the last generation would begin:

21:24 And they shall fall by the edge of the sword, and shall be led away captive into all nations: and Jerusalem shall be trodden down of the Gentiles, until the times of the Gentiles be fulfilled.

Israel became a nation in 1948 and Jerusalem returned back to Jewish hands after almost 2000 years of gentile control in 1968. This prophecy was fulfilled. Luke 21:32 finalizes it with:

21:32 Verily I say unto you, This generation shall not pass away, till all be fulfilled.

This generation of the fig tree. Israel is compared to the fig tree many times in scripture. No one knows the exact date when God closes out this time period, but Yeshua did give us the season. Yeshua said this generation will not listen to these signs.

Matthew 11:16 But whereunto shall I liken this generation? It is like unto children sitting in the markets, and calling unto their fellows,

Malachi 4:5 Behold, I will send you Elijah the prophet before the coming of the great and dreadful day of the LORD: 4:6 And he shall turn the heart of the fathers to the children, and the heart of the children to their fathers, lest I come and smite the earth with a curse.

This is a warning to us about the end days. It reveals there are two sets of children and two

fathers. Cain is the son of Satan and God is warning us of them in many places in the bible, not to hate them, but to know the enemy and be wiser than him.

It all goes back to the beginning

Genesis 3:1-7 & 15

Now the serpent was more subtil than any beast of the field which the LORD God had made. And he said unto the woman, Yea, hath God said, Ye shall not eat of every tree of the garden? 2 And the woman said unto the serpent, We may eat of the fruit of the trees of the garden: 3 But of the fruit of the tree which is in the midst of the garden, God hath said, Ye shall not eat of it, neither shall ye touch it, lest ye die. 4 And the serpent said unto the woman, Ye shall not surely die: 5 For God doth know that in the day ye eat thereof, then your eyes shall be opened, and ye shall be as gods, knowing good and evil. 6 And when the woman saw that the tree was good for food, and that it was pleasant to the eyes, and a tree to be desired to make one wise, she took of the fruit thereof, and did eat, and gave also unto her husband with her; and he did eat. 7 And the eyes of them both were opened, and they knew that they were naked; and they sewed fig leaves together, and made themselves aprons.

Lets define these words in the Hebrew manuscripts:

Serpent #5172-5175, Nachash, naw-khawsh', has several possible meanings. #5172 means to hiss, whisper a (magic) spell. #5173 means an incantation or augury; enchantment. #5174 means copper or brass, shining. #5175 means snake (from its hiss) a serpent.

The word in the manuscripts is nachash #5174 a shining one like brass or copper. The word tells us that Satan comes as an angel of light (shining one):

2 Corinthians 11:14 And no marvel; for Satan himself is transformed into an angel of light.

Let's continue with the other words in Genesis 3:1-7:

Subtle #6175 Aruwm, aw-rome'; cunning (usually in a bad sense), crafty.

Beast #2416 Chay, khah-ee'; from 2421; Alive; hence raw (flesh) fresh, (plant, water, year), strong; also life or a living thing.

Tree #6086 'Ets, ates; from 6095; a tree (from firmness), hence wood. #6095 Atsah, aw-tsaw'; a prime root; prop to fasten (or make firm) i.e. to close (the eyes), shut.

Upon reading the meanings of these words from the Hebrew manuscripts, a better understanding of what happened in the garden between Eve, the woman Messiah would come through, and Satan can be rendered. Let's read the passage now with the Hebrew meanings:

"Now, the shining one was more crafty than any living being which the Lord God had made." Eve is talking with a beautiful shining (copper) being who encourages her to go against what God has said, thus shutting (atsah) herself off to God. The tree is an interesting picture of the knowledge of good and evil. Knowledge is in your brain, and your brain sends messages to your body through your spinal cord which is made firm by being surrounded by your backbone and support your body. Do trees possess knowledge? No, they do not, so what is this tree God tells Eve to stay away from? What was Eve's real choice in the garden? The other tree was the tree of life. Yeshua/Jesus gives us eternal life and fellowship with God/himself. God is called a green fir tree (Hosea 14:8). when we partake of Yeshua we have life, Eve chose to leave that fellowship and follow the words of Satan. For this God drove Adam and Eve from the garden. The tree of the knowledge of good and evil is a hidden mystery, it was Satan. Eve had fellowship with God at this time, so when she sinned, she really did not have illumination of all knowledge, for that only comes from God, instead she and Adam fell spiritually and were separated and shut off (atsah) from God. Eve says she was not to touch the tree. This word means to lie with a woman. In Genesis 3:13 Eve draws and even clearer picture of what she and Satan did:

"And the LORD God said unto the woman, What is this that thou hast done? And the woman said, The serpent beguiled me, and I did eat."

There are three Hebrew words for beguiled in the Strong's Concordance as used in the manuscripts:

#5377 *Nasha*, naw-shaw; a prime root to lead astray (i.e.mentally) to delude, or (morally) to seduce: beguiled, deceive, greatly, utterly.

#5230 *Nakal*, naw-kal; a prime root, to defraud, act treacherously, beguile, conspire, deceiver, deal subtilly.

#7411 *Ramah*, raw-haw; A prime root; to hurl down, to shoot, fig. to delude or betray (as if causing to fall), beguile, betray, deceive, throw.

Satan the shining one seemed to cause Adam and Eve to fall, by betrayal as #7411 says, and he deceived and defrauded them because they would not be as God by taking part of the tree of Knowledge of good and evil, but those are not the words God chose to use in Genesis 3:13. No, God used the word #5377 to seduce, to lie with sexually. Paul spoke of this in 2 Corinthians 11:3 warning the believers not to be led astray as Eve was, but to remain chaste virgins:

"But I fear, lest by any means, as the serpent beguiled Eve through his subtilty, so your minds should be corrupted from the simplicity that is in Christ."

Now, Paul is trying to protect their minds from false teachers used by Satan, but what does he say of Eve--the serpent (shining) one beguiled Eve.

Beguiled # 1818 Exapatao, ex-ap-at-ah'-o, form 1537 and 538; to seduce wholly, beguile, deceive.

What does this show us of the interaction between Satan and Eve? All three Hebrew words: Nasha, Nakal, Ramah are translated beguiled but only Nasha means sexual seduction, and that is the word used for beguiled in Genesis 3:13. The Greek word exapatao means seduction. It is clear from the manuscripts that Satan seduced Eve sexually and she bore Cain!

THIS CAN'T BE !

How can Satan and Eve join this way? Most people are taught that Satan conned Eve into biting an apple which she then shared with Adam who knew better. For their defiance God cast them out of the garden because they simply fell away from Him. But what of this mixing between an angel (messenger) and flesh people?

Genesis 6:1-4

And it came to pass, when men began to multiply on the face of the earth, and daughters were born unto them, 2 That the sons of God saw the daughters of men that they were fair; and they took them wives of all which they chose. 3 And the LORD said, My spirit shall not always strive with man, for that he also is flesh: yet his days shall be an hundred and twenty years. 4 There were giants in the earth in those days; and also after that, when the sons of God came in unto the daughters of men, and they bare children to them, the same became mighty men which were of old, men of renown.

*note the word men here is the singular form with the article in Hebrew, thus it should read, "the man Adam".

Sons of God is a Hebrew idiom which means angels.

Giants #5303 Nephilim, nef-eel-eem; from 5307 naphal, naw-phal; to fall, many applications (lit. or fig) cast down, fall away.

mighty # 1368 Gibbor, Gee-bore; mighty, powerful, warrior, champion.

Some teach that the sons of God refers to the good line of Seth, but there is nothing in scripture that would separate Seth's children as superior and better to take Adam's daughters, their sisters. Seth's children are not recorded as being huge in comparison to other children God made. We have a description of how massive these men were in 1 Samuel 17:4-7:

"And there went out a champion out of the camp of the Philistines, named Goliath, of Gath, whose height was six cubits and a span. :5 And he had an helmet of brass upon his head, and he was armed with a coat of mail; and the weight of the coat was five thousand shekels of brass. 6 And he had greaves of brass upon his legs, and a target of brass between his shoulders. 7 And the staff of his spear was like a weaver's beam; and his spear's head weighed six hundred shekels of iron: and one bearing a shield went before him."

Goliath stood between ten and thirteen feet tall! His armor weighed hundreds of pounds. He was a progeny of the union between the fallen angels and the daughters of Adam. These angels are held in chains today waiting eternal damnation.

Jude 1:6-7

"And the angels which kept not their first estate, but left their own habitation, he hath reserved in everlasting chains under darkness unto the judgment of the great day.⁷ Even as Sodom and Gomorrah, and the cities about them in like manner, giving themselves over to fornication, and going after strange flesh, are set forth for an example, suffering the vengeance of eternal fire."

Their first estate is better read, their own principality/realm, thus we see the supernatural sons of God mixed with flesh daughters of man and the offspring was this hybrid God never wanted on the earth. That is why Noah's flood happened. Many people believe that the flood was brought on because man was wicked, and only Noah survived because he was good and walked perfectly before God. In verse 7 of Jude it says the people went after "strange flesh", and we know that the people wanted Lot to hand over these "strange" men in order to have sex with them. Who were these "strange" men?

Genesis 19:1-5

"And there came two angels to Sodom at even; and Lot sat in the gate of Sodom: and Lot seeing them rose up to meet them; and he bowed himself with his face toward the ground; 2 And he said, Behold now, my lords, turn in, I pray you, into your servant's house, and tarry all night, and wash your feet, and ye shall rise up early, and go on your ways. And they said, Nay; but we will abide in the street all night. 3 And he pressed upon them greatly; and they turned in unto him, and entered into his house; and he made them a feast, and did bake unleavened bread, and they did eat. 4 But before they lay down, the men of the city, even the men of Sodom, compassed the house round, both old and young, all the people from every quarter: 5 And they called unto Lot, and said unto him, Where are the men which came in to thee this night? bring them out unto us, that we may know them."

From this incident we see that the angels were in the form of men. They ate food, thus they had ability to mix physically. All the men of the city wanted to "know" these angels. These wicked men did not want Lot's virgin daughters, no, they wanted the angels (Genesis 19:8). They wanted to "know" them, a polite way of saying have carnal knowledge or have sexual relations. These angels were righteous servants of God, but if they had not been righteous, they may have done what the angels, sons of God, in Genesis 6 did with the daughters of Adam. One must ask why the angels wanted the daughters of Adam? It is simple. It was through the daughters of Adam and Eve that Messiah would come. If Satan could destroy the seed line by making it impure then no Messiah, and Satan wins. It's the same reason why Satan has tried to destroy the children of God over and over, if no nation or seed of Abraham, Isaac and Jacob then Satan wins.

Kenites are the children

of Satan

Remember, the term **Kenite** in scripture means sons of Cain. They are of their father, and do the works of their father. They survived the flood of Noah:

1 Chronicles 2:55 "And the families of the scribes which dwelt at Jabez; the Tirathites, the Shimeathites, and Suchathites. These are the Kenites that came of Hemath, the father of the house of Rechab. "

Well, there they are, right there in the tribes of God's people Israel as Scribes! How did they come to dwell with these people of God?

Jeremiah 35:1-11

"The word which came unto Jeremiah from the LORD in the days of Jehoiakim the son of Josiah king of Judah, saying, 2 Go unto the house of the Rechabites, and speak unto them, and bring them into the house of the LORD, into one of the chambers, and give them wine to drink. 3 Then I took Jaazaniah the son of Jeremiah, the son of Habaziniah, and his brethren, and all his sons, and the whole house of the Rechabites; 4 And I brought them into the house of the LORD, into the chamber of the sons of Hanan, the son of Igdaliah, a man of God, which was by the chamber of the princes, which was above the chamber of Maaseiah the son of Shallum, the keeper of the door: 5 And I set before the sons of the house of the Rechabites pots full of wine, and cups, and I said unto them, Drink ye wine. 6 But they said, We will drink no wine: for Jonadab the son of Rechab our father commanded us, saying, Ye shall drink no wine, neither ye, nor your sons for ever: 7 Neither shall ye build house, nor sow seed, nor plant vineyard, nor have any: but all your days ye shall dwell in tents; that ye may live many days in the land where ye be strangers. 8 Thus have we obeyed the voice of Jonadab the son of Rechab our father in all that he hath charged us, to drink no wine all our days, we, our wives, our sons, nor our daughters; 9 Nor to build houses for us to dwell in: neither have we vineyard, nor field, nor seed: 10 But we have dwelt in tents, and have obeyed, and done according to all that Jonadab our father commanded us. 11 But it came to pass, when Nebuchadrezzar king of Babylon came up into the land, that we said, Come, and let us go to Jerusalem for fear of the army of the Chaldeans, and for fear of the army of the Syrians: so we dwell at Jerusalem."

***note the Jeremiah son of Habazinaih is not the prophet Jeremiah the son of Hilkiah, a priest of the Levites. (Jer. 1:1)**

This passage nails down who the Kenites are, the curse of Cain upon them, and the one sad note concerning them. First, they are Rechabites, and as we learned in 1 Chronicles 2:55 these are the Kenites. They drink no wine. All Kenites are there in the Land, "whole house of Rechab". Verse 7 tells us of the curse of Cain in that they do not build houses to live in, sow seed, nor plant vineyards, all their days they will dwell in tents, and most sadly, they obeyed

the voice of their father (Cain) that they may dwell many days in the land of strangers. Is this not what God said to Cain?

Genesis 4:11-12

"And now art thou cursed from the earth, which hath opened her mouth to receive thy brother's blood from thy hand; 12 When thou tillest the ground, it shall not henceforth yield unto thee her strength; a fugitive and a vagabond shalt thou be in the earth."

Oh, how it must sadden our Father that we do not obey His voice as the Kenites obey their Father. And what did He say concerning the Kenites and the children of Abraham?

Jeremiah 35:12-19

"Then came the word of the LORD unto Jeremiah, saying, 13 Thus saith the LORD of hosts, the God of Israel; Go and tell the men of Judah and the inhabitants of Jerusalem, Will ye not receive instruction to hearken to my words? saith the LORD. 14 The words of Jonadab the son of Rechab, that he commanded his sons not to drink wine, are performed; for unto this day they drink none, but obey their father's commandment: notwithstanding I have spoken unto you, rising early and speaking; but ye hearkened not unto me. 15 I have sent also unto you all my servants the prophets, rising up early and sending them, saying, Return ye now every man from his evil way, and amend your doings, and go not after other gods to serve them, and ye shall dwell in the land which I have given to you and to your fathers: but ye have not inclined your ear, nor hearkened unto me. 16 Because the sons of Jonadab the son of Rechab have performed the commandment of their father, which he commanded them; but this people hath not hearkened unto me: 17 Therefore thus saith the LORD God of hosts, the God of Israel; Behold, I will bring upon Judah and upon all the inhabitants of Jerusalem all the evil that I have pronounced against them: because I have spoken unto them, but they have not heard; and I have called unto them, but they have not answered. 18 And Jeremiah said unto the house of the Rechabites, Thus saith the LORD of hosts, the God of Israel; Because ye have obeyed the commandment of Jonadab your father, and kept all his precepts, and done according unto all that he hath commanded you: 19 Therefore thus saith the LORD of hosts, the God of Israel; Jonadab the son of Rechab shall not want a man to stand before me for ever."

Well, now that is an indictment against us, the children of God. Now, I will admit it is easier to serve Satan in flesh, than God in spirit ("the spirit is willing but the flesh is weak") in that in the flesh we all have times of great anger, jealousy, and selfishness, but God provides a way for us to escape the temptations to sin, if we will remain in Him. Notice how God kept referring to the children of Judah not hearing His instructions? They did not have the spiritual eyes to see and ears to hear what the Lord was saying. Yeshua/Jesus faced the same problems 2000 years ago, and it is the same today. The people did their "religious" duty, but their hearts were far from God. They were so spiritually blind that they did not even know the Scribes and Pharisees were Kenites!

Kenites masquerading as Jews

As we have seen already, the manuscripts of the Hebrew and Greek can be mistranslated to try to convey a meaning in English. I do not believe that the writers of the King James Bible tried to twist scripture. They stated in the introduction to the 1611 KJV that translating some words was difficult, but they did the best they could so we could read the Holy word of God in our own tongue for ourselves. When reading the bible it is imperative that you remember the time it was written and what those words meant. For instance, when we say the word Jew today, we assume someone means of the children of Abraham. That is not the only meaning in the word of God.

#2453 loudais, ee-oo-dah'-yos; from 2448 (in the sense of 2455 as a country); Judoean, i.e. belonging to Jehudah; --Jew(ess) of Judea.

#2448 louda, ee-oo-dah'; of Heb or Judah (i.e. Juhudah or Juttah), a part of (or place in) Palestine; Judea.

This term Jew in the bible means either a child of Abraham's Lineage (the tribe of Judah) or someone residing in the land of Judea.

Let's shed some skin

"Adam" means ruddy complected. This means to show blood in the face, to turn red. Now, the word Adam without an article in the Hebrew is a word meaning people/man, not any particular race. If it has an article such as 'eth ha Adam", then it means the man God formed to till the earth, and he is ruddy complected. Only one race is ruddy complected, and that is the white race. When God evicted the ten northern tribes of Israel, they went north over the caucuses' mountains and became known as Caucasians. They settled all over the world and we know them today as primarily the white Christian nations. As a punishment for their idolatry and stiff necked rejection of God's law, they were swallowed up by the gentile nations and forgotten. They do not know they are of the tribes of Israel, and so still bear the punishment for their fathers rejection of God. The book of Hosea reveals this secret:

Hosea

7:8 "Ephraim, he hath mixed himself among the people; Ephraim is a cake not turned. 9 Strangers have devoured his strength, and he knoweth it not: yea, gray hairs are here and there upon him, yet he knoweth not."

8:8 "Israel is swallowed up: now shall they be among the Gentiles as a vessel wherein is no pleasure."

8:11 "Because Ephraim hath made many altars to sin, altars shall be unto him to sin. 12 I have

written to him the great things of my law, but they were counted as a strange thing."

9:16 "Ephraim is smitten, their root is dried up, they shall bear no fruit: yea, though they bring forth, yet will I slay even the beloved fruit of their womb. 17 My God will cast them away, because they did not hearken unto him: and they shall be wanderers among the nations."

The Southern Kingdom remained several hundred years in Judea after the ten Northern tribes were dispersed. They too were eventually evicted by God, and prophetically returned to their land in 1948. As a high tribute to their father King David, and his faithfulness, they were given the honor of God's word and the identity of their people, the Jews. Remember, though, Kenites were residing with them, thus they continued to call themselves Jews, and when Judah returned in 1948 so did the Kenites!

Revelation

2:8 "And unto the angel of the church in Smyrna write; These things saith the first and the last, which was dead, and is alive; 9 I know thy works, and tribulation, and poverty, (but thou art rich) and I know the blasphemy of them which say they are Jews, and are not, but are the synagogue of Satan."

to the church of Philadelphia:

3:9 "Behold, I will make them of the synagogue of Satan, which say they are Jews, and are not, but do lie; behold, I will make them to come and worship before thy feet, and to know that I have loved thee."

The only two churches approved of by God are Philadelphia and Smyrna, and they know about the Kenites. Notice; however, that God didn't blast all Jews, just those claiming to be and lying about it. So, don't get God angry by hating Jews and calling them the synagogue of Satan, because the real sons of Judah are precious and beloved of God, they are the "apple of His eye". To please God in the body and be approved one must know the mystery of the Kenites and the enmity between the seed of Satan and God's seed.

Fear Not

God is giving us good news in his word so we need not fear the future. The Kenites are to be known and "respected" in that they obey their father. The children of Cain are in this world as a fulfillment of prophecy. We are admonished to be wise as serpents and gentle as doves. That is why we study the word of God, to be a workman not ashamed to stand before our Father. Much of the church is asleep like the five virgins without enough oil in their lamp for the journey. When the destroyer comes, they will not be ready, but God is equipping the saints with these "secrets" so we can stand and fight the good fight and not fear the enemy. We know how it will all end, WE WIN!

Luke 10:19 "Behold, I give unto you power to tread on serpents and scorpions, and over all the

power of the enemy: and nothing shall by any means hurt you."

Revelation 9:3-4 "And there came out of the smoke locusts upon the earth: and unto them was given power, as the scorpions of the earth have power. 4 And it was commanded them that they should not hurt the grass of the earth, neither any green thing, neither any tree; but only those men which have not the seal of God in their foreheads."

These are not bugs coming to get people on the earth. This is a spiritual battle. What do locusts do? They devour everything green! Strip off the bark even, so it is dead, can't reproduce, famine is the result. What do scorpions do? They sting their prey and inject them with poison to turn their insides to mush so they may eat them. What is in your forehead? Your brain! What is the seal of God? It is the word of God. Yeshua/Jesus said "if you love me, you will keep my commandments." The only way to know the commandments of God is to know His word. The people in the church who don't know the truth will be deceived by this Locust army.

2 Thessalonians 2:10-11

"And with all deceivableness of unrighteousness in them that perish; because they received not the love of the truth, that they might be saved. 11 And for this cause God shall send them strong delusion, that they should believe a lie:"

Only those who love God have the seal of God in their foreheads/minds. If you are a believer and do not care to study the word of God, then you will be deceived by this strong delusion of the locust army. The answers are in the word of God. The battle is beginning to take shape, and the Kenites are in place. Now, many will say, "Well, you don't know what your talking about, because it says in the bible that Moses married a Kenite, so they are in the lineage of God's people and are righteous now."

Did Moses marry a Kenite?

In the book of Judges, we have the passage which clearly says that Moses married a daughter of a Kenite, right? Wrong! The passage says:

Judges 1:16

"And the children of the Kenite, Moses' father in law, went up out of the city of palm trees with the children of Judah into the wilderness of Judah, which lieth in the south of Arad; and they went and dwelt among the people."

Who was Moses' father in law? He was a Midianite priest living in the region of the Kenites. The book of Numbers gives us this information, remember to rightly divide the word of truth, to clear things up.

Numbers 10:29 "And Moses said unto Hobab, the son of Raguel the Midianite, Moses' father in

law, We are journeying unto the place of which the LORD said, I will give it you: come thou with us, and we will do thee good: for the LORD hath spoken good concerning Israel."

Who were the Midianites? Why did Moses take a wife from these people? Remember the events which led up to Moses meeting these Midianites. Moses had to rescue the daughters of Raguel from the people who owned the well in that region. Who were these people? They were Kenites.

Exodus 2:16-19

"Now the priest of Midian had seven daughters: and they came and drew water, and filled the troughs to water their father's flock. 17 And the shepherds came and drove them away: but Moses stood up and helped them, and watered their flock. 18 And when they came to Reuel their father, he said, How is it that ye are come so soon to day? 19 And they said, An Egyptian delivered us out of the hand of the shepherds, and also drew water enough for us, and watered the flock."

Here we have a priest of Midian with seven daughters trying to water their sheep and as soon as they have drawn water, lo and behold the shepherds show up to water their sheep, and drive the women away. The father notices they completed their task more quickly than usual and he asks what changed that day? The idea is they got driven away often and had to wait. The spelling of the priests name is different than in Numbers 10:29 only because some letters get switched in scripture, but he is clearly the same man. It appears to be a common occurrence to be driven away from the well, why? These women were not of the same tribe as the shepherds, and were viewed as guests/trespassers so the shepherds had territorial rights so to speak. Notice also the women call Moses an Egyptian. It seems they interpret ones clothing as who someone is, because Moses is clearly a Jew.

Who are the Midianites?

Genesis 25:1-2 gives us the identity of the Midianites. They are the children of Abraham through his wife Keturah.

"Then again Abraham took a wife, and her name was Keturah. 2 And she bare him Zimran, and Jokshan, and Medan, and Midian, and Ishbak, and Shuah."

This shows the children born to Abraham through his lawful wife Keturah. The actual wording should be, "Abraham took another wife", instead of again. It appears Sarah died. As Abraham was a spiritual man, he passed his beliefs on to these sons as well, thus we see in Exodus chapter 2 the Midianite priest who no doubtedly served the God of Abraham. That is the background of the daughter of Raguel whom Moses married, not a Kenite!

The Midianite people were living in the region of the Kenites. They were not treated well as Numbers 10:29 shows. Why? They were not Kenites by blood, only residing in the Kenite area. When Columbus sailed and came to America, he mistakenly called the native people Indians

because he thought he was in India. We white Anglo Saxons are no closer to being Indians than those Midianites living in Kenite territory were to being Kenites, but in Genesis 25 the Midianites are called Kenites. Moses married the daughter, Zipporah, of a Midianite priest.

It is clear that through carefully studying the scriptures we find that Kenites did not marry into the children of Abraham to become "sons of Abraham". They claim to be of our brother Judah and lie (Revelation 2:9 & 3:9).

Generation of Vipers

Our brother Judah has suffered much at the hands of these children of Cain, the Kenites. As we have already seen in 1 Chronicles 2:55 they became scribes of the tribes of Israel. And these Kenites moved into the land of Judea to dwell in Jerusalem, Judah's land in Jeremiah 35:1-11. Now, what did Yeshua/Jesus say concerning this group of people? Biblical illiteracy still hurts our brother Judah today. How many years have they bore the title "Christ Killer"? Any students of the word could tell you who bruised Messiah, Satan through his seed the Kenites.

Genesis 3:15

"And I will put enmity between thee and the woman, and between thy seed and her seed; it shall bruise thy head, and thou shalt bruise his heel."

Who is this enmity between? Satan's seed and the woman's seed. Messiah is the only seed of a woman, because no man had a part in His conception. Yeshua would destroy Satan, but Satan would bruise Him. Yeshua knew who His enemy was, and it was not our brother Judah. It was the Kenites masquerading as Jew/Israelites.

Matthew 23:29-35

"Woe unto you, scribes and Pharisees, hypocrites! because ye build the tombs of the prophets, and garnish the sepulchres of the righteous, 30 And say, If we had been in the days of our fathers, we would not have been partakers with them in the blood of the prophets. 31 Wherefore ye be witnesses unto yourselves, that ye are the children of them which killed the prophets. 32 Fill ye up then the measure of your fathers. 33 Ye serpents, ye generation of vipers, how can ye escape the damnation of hell? 34 Wherefore, behold, I send unto you prophets, and wise men, and scribes: and some of them ye shall kill and crucify; and some of them shall ye scourge in your synagogues, and persecute them from city to city: 35 That upon you may come all the righteous blood shed upon the earth, from the blood of righteous Abel unto the blood of Zacharias son of Barachias, whom ye slew between the temple and the altar."

Who was Yeshua talking to? He was speaking to the scribes (Kenites) and Pharisees (kenites)! The Leadership of the Jewish people were a bunch of Kenites! Yeshua tells us they are the children of those who killed the prophets from righteous Abel to Zacharias. Who killed Abel? Cain killed Abel, it is as easy as that to know who was after Yeshua's head. *Note, there were some Jews/of Judah in the Pharisees, the most notable is Paul/Saul of Tarsis, but the

leaders were Kenites.

John 8:39-47

"They answered and said unto him, Abraham is our father. Jesus saith unto them, If ye were Abraham's children, ye would do the works of Abraham. 40 But now ye seek to kill me, a man that hath told you the truth, which I have heard of God: this did not Abraham. 41 Ye do the deeds of your father. Then said they to him, We be not born of fornication; we have one Father, even God. 42 Jesus said unto them, If God were your Father, ye would love me: for I proceeded forth and came from God; neither came I of myself, but he sent me. 43 Why do ye not understand my speech? even because ye cannot hear my word. 44 Ye are of your father the devil, and the lusts of your father ye will do. He was a murderer from the beginning, and abode not in the truth, because there is no truth in him. When he speaketh a lie, he speaketh of his own: for he is a liar, and the father of it. 45 And because I tell you the truth, ye believe me not. 46 Which of you convinceth me of sin? And if I say the truth, why do ye not believe me? 47 He that is of God heareth God's words: ye therefore hear them not, because ye are not of God."

How much simpler can it get? They claim to be of Abraham (Jews) and Yeshua says they are not of Abraham. This is not just a heart condition as Matthew 23 clearly states their father killed Abel. Then they lie again and say they were not born of fornication, which we all know by now that is exactly how Cain got here. And in verse 44, Yeshua says it openly, "Ye are of your father the devil." They have no ears to hear. They are in the highest positions on political and religious power. The Kenites wanted Yeshua dead, and they KILLED YESHUA!

Understand your Enemy

Satan is the enemy of your soul. All things were created by God, and God wants none to perish (John 3:16); however, some will not choose to love God and have Him as their Father. These are the end days and the book of life is closing. There is a spiritual battle going on right now for your soul. Even a Kenite can become a child of God. Once you accept Yeshua into your heart, you are a new creation, behold the old passes away and the new begins! Kenites are not to be hated and killed. God put a mark on Cain and his children to protect them (Genesis 4). The mark is viewed by some as an inability to blush. Review the book of Jeremiah and see how the false shepherds of Jeremiah 34 are chastised by God as well as in Jeremiah 6:15 and 8:12. They feel no sense of shame in wrong doing. It would seem appropriate to put such a strange mark upon this race of white (Eve came from Adam) men. Since Cain came from Eve, he was white, and could blush before he was marked by God. This is not a point to argue, there is certainly a good case to made for their inability to blush.

As with all truth, Satan will do everything to twist and confuse the children of God. I have studied many of the world religions, and there is a grain of truth in most of them, but they have some teachings that simply are not in the scriptures. The modern day Identity movement preaches the Christian White nations of the world are the true children of God, and the people

in Israel claiming to be God's children the Jews are liars and Caananites. These Identity people truly believe this, and therefore throw out the entire nation of Israel as false children of God, and not of Abraham's' seed. It is my desire to shed light upon this subject through the scriptures.

The nation of Israel today has both Abraham's seed/children and Kenites claiming to be Abraham's children. The ten northern tribes are still dispersed and lost in who they are. They will not be rejoined to Judah and Benjamin until the Millennial Kingdom begins.

Ezekiel 37:15-17

"The word of the LORD came again unto me, saying, 16 Moreover, thou son of man, take thee one stick, and write upon it, For Judah, and for the children of Israel his companions: then take another stick, and write upon it, For Joseph, the stick of Ephraim and for all the house of Israel his companions: 17 And join them one to another into one stick; and they shall become one in thine hand."

This is a millennial prophecy. Today the sticks are not together. God tells us when they will be put together in Ezekiel 37:22-24:

"And I will make them one nation in the land upon the mountains of Israel; and one king shall be king to them all: and they shall be no more two nations, neither shall they be divided into two kingdoms any more at all. 23 Neither shall they defile themselves any more with their idols, nor with their detestable things, nor with any of their transgressions: but I will save them out of all their dwellingplaces, wherein they have sinned, and will cleanse them: so shall they be my people, and I will be their God. 24 And David my servant shall be king over them; and they all shall have one shepherd: they shall also walk in my judgments, and observe my statutes, and do them."

According to these verses, the sticks are joined when they have one king, David, and one shepherd over them. This is what happens during the Millenium reign of Messiah Yeshua. I have noticed that we still re not observing and doing God's judgements and statutes, so the sticks are not together yet. I do not want to take anything away from our brother Judah. The timetable of prophecy is read from the things which happen in Jerusalem. Our Jewish brothers and sisters deserve our love and respect. Pray for God to bless them and keep them from all harm. May they have peace in Jerusalem, the Land of our people and our God.

In the last days Yeshua said:

Mark 9:11-12

"And they asked him, saying, Why say the scribes that Elias must first come? 12 And he answered and told them, Elias verily cometh first, and restoreth all things; and how it is written of the Son of man, that he must suffer many things, and be set at nought."

This verse comes from Malachi:

4:5 Behold, I will send you Elijah the prophet before the coming of the great and dreadful day of the LORD:6 And he shall turn the heart of the fathers to the children, and the heart of the children to their fathers, lest I come and smite the earth with a curse."

These are plural fathers in two lines, good seed and wicked seed. God's children and Satan's children.

Mark 13:22 "For false Christ's and false prophets shall rise, and shall shew signs and wonders, to seduce, if it were possible, even the elect.23 But take ye heed: behold, I have foretold you all things."

Look up for thy redemption draweth nigh

[Back to Christian Links](#)

To continue with the study, see "[the Garden of Eden](#)" and "[the Two Figs](#)"

The Cross and Crucifixion.

This Is Appendix 162 From The Companion Bible.

In the Greek New Testament two words are used for "the cross" on which the Lord was put to death.

1. The word *stauros*; which denotes an upright pole or stake, to which the criminals were nailed for execution.

2. The *xulon*, which generally denotes a piece of a dead log of wood, or timber, for fuel or for any other purpose. It is not like *dendron*, which is used of a living, or green tree, as in Matthew 21:8; Revelation 7:1, 3; 8:7; 9:4, etc.

As this latter word *xulon* is used for the former *stauros*, it shows us that the meaning of each is exactly the same.

The verb *stauroō* means to drive stakes.¹

Our English word "cross" is the translation of the Latin *crux*; but the Greek *stauros* no more means a *crux* than the word "stick" means a "crutch".

Homer uses the word *stauros* of an ordinary pole or stake, or a single piece of timber.² And this is the meaning and usage of the word throughout the Greek classics.³

It never means *two* pieces of timber placed across one another at any angle, but always of one piece alone. Hence the use of the word *xulon* (No. 2, above) in connection with the manner of our Lord's death, and rendered "tree" in Acts 5:30; 10:39; 13:29. Galatians 3:13. 1 Peter 2:24. This is preserved in our old English name *rood*, or *rod*. See the *Encycl. Brit.*, 11th (Camb.) ed., volume 7, page 505d.

There is nothing in the Greek of the New Testament even to imply two pieces of timber.

The letter *chi*, χ , the initial of the word Christ **X**, was originally used for His Name; or **X** ρ . This was superseded by symbols ρ and ρ , and even the first of these had four *equal* arms.

These crosses were used as symbols of the Babylonian sun-god, \oplus , and are first seen on a coin of Julius Cæsar, 100 - 44 B.C., and then on a coin struck by Cæsar's heir (Augustus), 20 B.C.⁴

On the coins of Constantine the most frequent symbol is ρ ; but the same symbol is used without the surrounding circle, and with the four equal arms vertical and horizontal; and this was the symbol specially venerated as the "Solar Wheel". It should be stated that Constantine was a sun-god worshipper, and would not enter the "Church" till some quarter of a century after the legend of his having seen such a cross in the heavens (EUSEBIUS, *Vit. Const.* I. 37).

The evidence is the same as to the pre-Christian (phallic) symbol in Asia, Africa, and Egypt, whether we consult *Nineveh* by Sir A. H. LAYARD (ii 213), or *Manners and Customs of the Ancient Egyptians*, by Sir J. GARDNER WILKINSON, iii. pages 24, 26, 43, 44, 46, 52, 82, 136.

Dr. SCHLIEMANN gives the same evidence in his *Ilios* (1880), recording his discoveries on the site of prehistoric Troy. See pages 337, 350, 353, 521, 523.

Dr. MAX OHNEFALSCH - RICHTER gives the same evidence from Cyprus; and these are "the oldest extant Phoenician inscriptions"; see his *Kypros, the Bible, and Homer : Oriental Civilisation, Art, and Religion in Ancient Times*, Plates XIX, XXV, XXVI, XXX, XXXI, XXXII, XL, LVIII, LXIX, etc.

The Catacombs in Rome bear the same testimony : "Christ" is never represented there as "hanging on a cross", and the cross itself is only portrayed in a veiled and hesitating manner. In the Egyptian churches the cross was a pagan symbol of life, borrowed by the Christians, and interpreted in the pagan manner. See the *Encycl. Brit.*, 11th (Camb.) ed., volume 14, page 273.

In his *Letter from Rome* Dean Burgon says : "I question whether a cross occurs on any Christian monument of the first four centuries".

In Mrs. Jameson's famous *History of our Lord as Exemplified in Works of Art*, she says (volume ii, page 315) : "It must be owned that ancient objects of art, as far as hitherto known, afford no corroboration of the use of the cross in the simple transverse form familiar to us, at any period preceding, or even closely succeeding, the time of Chrysostom"; and Chrysostom wrote half a century after Constantine!

"The Invention of the Cross" by Helena the mother of Constantine (in 326), though it means her *finding* of the cross, may or may not be true; but the "invention" of it in pre-Christian times, and the "invention" of its use in later times, are truths of which we need to be reminded in the present day. The evidence is thus complete, that the Lord was put to death upon an upright stake, and not on two piece of timber placed at any angle.

NOTES

¹ There are two compounds of it used : *sustauroo* = to put any one thus to death with another (Matthew 27:44. Mark 15:32. John 19:32. Romans 6:6. Galatians 2:20); and *anastauroo* = to rise up and fix upon the stake again (Hebrews 6:6). Another word used is equally significant : *prospegnumi* = to fix or fasten anything (Acts 2:23).

² *Iliad* xxiv. 453. *Odyssey* xiv. 11.

³ For example, Thucydides iv. 90. Xenophon, *Anabasis* v. 2. 21.

⁴ Other coins with this symbol were struck by Augustus, also by Hadrian and other Roman emperors. See *Early Christian Numismatics*, by C. W. King, M.A.

[\[Christian Links\]](#)



The Serpent of Genesis 3.

Appendix 19 From The Companion Bible.

In Genesis 3 we have neither allegory, myth, legend, nor fable, but literal historical facts set forth, and emphasized by the use of certain Figures of speech.

All the confusion of thought and conflicting exegesis have arisen from taking literally what is expressed by Figures, or from taking figuratively what is literal. A Figure of speech is never used except for the purpose of calling attention to, emphasizing, and intensifying, *the reality of the literal sense*, and truth of the historical facts; so that, while the words employed may not be so strictly true to the letter, they are all the more *true to the truth conveyed by them*, and to the historical events connected with them.

But for the figurative language of verses 14 and 15 no one would have thought of referring the third chapter of Genesis to a snake; no more than he does when reading the third chapter from the end of Revelation (chapter 20:2). Indeed, the explanation added there, that the "*old* serpent" is the Devil and Satan, would immediately lead one to connect the word "old" with the *earlier* and former mention of the serpent in Genesis 3: and the fact that it was Satan himself who tempted "the second man", "the last Adam", would force the conclusion that no other than the personal Satan could have been the tempter of "the first man, Adam".

The Hebrew word rendered "serpent" in Genesis 3:1 is *Nachash* (from the root *Nachash, to shine*, and means *a shining one*. Hence, in Chaldee it means *brass* or *copper*, because of its *shining*. Hence also, the word *Nehushtan*, a piece of brass, in 2Kings 18:4.

In the same way *Saraph*, in Isaiah 6:2,6, means *a burning one*, and, because the serpents mentioned in Numbers 21 were burning, in the poison of their bite, they were called *Saraphim*, or *Seraphs*.

But when the LORD said unto Moses, "Make thee a fiery serpent" (Numbers 21:8), He said, "Make thee a *Saraph*", and, in obeying this command, we read in verse 9, "Moses made a *Nachash* of brass". *Nachash* is thus used as being interchangeable with *Saraph*.

Now, if *Saraph* is used of a serpent because its bite was *burning*, and is also used of a celestial or spirit-being (a burning one), why should not *Nachas* be used of a serpent because its appearance was *shining*, and be also used of a celestial or spirit-being (a shining one)?

Indeed, a reference to the structure of Genesis 3 (on page 7) will show that the *Cherubim* (which are similar celestial or spirit-beings) of the last verse (Genesis 3:24) require a similar spirit-being to correspond with them in the first verse (for structure of the whole chapter is a great Introversion). The *Nachash*, or serpent, who beguiled Eve (2Corinthians 11:3) is spoken of as "an angel of light" in verse 14. Have we not, in this, a clear intimation that it was not a snake, but a glorious shining being, apparently an angel, to whom Eve paid such great deference, acknowledging him as one who seemed to

possess superior knowledge, and who was evidently a being of a superior (not of an inferior) order? Moreover, in the description of Satan as "the king of Tyre" ¹ it is distinctly implied that the latter being was of a super-natural order when he is called "a cherub" (Ezekiel 28:14,16, read from verses 11-19). His presence "in Eden, the garden of '*Elohim*'" (verse 13, is also clearly stated, as well as his being "perfect in beauty" (verse 12) his being "perfect" in his ways from the day he was created till iniquity was found in him" (verse 15), and as being "lifted up because of his beauty" (verse 17).

These all compel the belief that Satan was *the shining one* (*Nachash*) in Genesis 3, and especially because the following words could be addressed to him :- "Thine heart was lifted up because of thy beauty, thou hast corrupted thy wisdom by reason of thy brightness: I will cast thee to the ground, I will lay thee before kings, that they may behold thee" (verse 17).

Even supposing that these things were spoken to, and of, an exalted human being in later days (Ezekiel 28), still "the king of Tyre" is not compared to a being who was non-existent; and facts and circumstances which never happened are not introduced into the comparison.

There is more about "the king of Tyre" in Ezekiel 28:11-19 than was literally true of "the prince of Tyre" (verses 1-10). The words can be understood only of the mightiest and most exalted supernatural being that God ever created; and this for the purpose of showing how great would be his fall. The *history* must be true to make the *prophecy* of any weight.

Again, the word rendered "subtle" in Genesis 3:1 (see note) means *wise*, in a good sense as well as in a bad sense. In Ezekiel 28:12 we have the good sense, "Thou sealest up the sum, full of wisdom"; and the bad sense in verse 17, "thou hast corrupted thy wisdom" (referring of course, to his fall). So the word rendered "subtle" is rendered "prudent" in Proverbs 1:4; 8:12; 12:23; 14:8; and in a bad sense in Job 15:5. 1Samuel 23:22. Psalm 83:3.

The word "beast" also, in Genesis 3:1, *chay*, denotes *a living being*, and it is as wrong to translate *zoa* "beasts" in Revelation 4, as it is to translate *chay* "beast" in Genesis 3. Both mean *living creature*. Satan is thus spoken of as being "more wise than any other *living creature* which Jehovah Elohim had made". Even if the word "beast" be retained, it does not say that either a serpent or Satan *was* a "beast", but only that he was "more wise" than any other living being.

We cannot conceive Eve as holding converse with a snake, but we can understand her being fascinated ² by one, apparently "an angel of light" (i.e. a glorious angel), possessing superior and supernatural knowledge.

When Satan is spoken of as a "serpent", it is the figure *Hypocatastasis* or *Implication*; it no more means a snake than it does when Dan is so called in Genesis 49:17; or an animal when Nero is called a "lion" (2Timothy 4:17), or when Herod is called a "fox" (Luke 13:32); or when Judah is called "a lion's whelp". It is the same figure when "doctrine" is called "leaven" (Matthew 16:6). It shows that something much more real and truer to truth is intended. If a Figure of speech is thus employed, it is for

the purpose of expressing the truth more impressively ; and is intended to be a figure of something much *more real* than the letter of the word.

Other Figures of speech are used in verses 14,15, but only for the same purpose of emphasizing the truth and the reality of what is said.

When it is said in verse 15, "thou shalt bruise His heel", it cannot mean His literal heel of flesh and blood, but suffering, more temporary in character. When it is said (verse 15), "He shall crush the head", it means something more than a skull of bone, and brain, and hair. It means that all Satan's plans and plots, policy and purposes, will one day be finally crushed and ended, never more to mar or to hinder the purposes of God. This will be effected when Satan shall be bruised under our feet (Romans 16:20). This, again, will not be our literal feet, but something much more real.

The bruising of Christ's heel is the most eloquent and impressive way of foretelling the most solemn events; and to point out that the effort made by Satan to evade his doom, then threatened, would become the very means of insuring its accomplishment; for it was through the death of Christ that he who had the power of death would be destroyed; and all Satan's power and policy brought to an end, and all his works destroyed (Hebrews 2:14. 1John 3:8. Revelation 20:1-3,10). What literal words could portray these literal facts so wonderfully as these expressive Figures of speech ?

It is the same with the other Figures used in verse 14, "On thy belly shalt thou go". This Figure means infinitely more than the literal belly of the flesh and blood; just as the words "heel" and "head" do in verse 15. It paints for the eyes of our mind the picture of Satan's ultimate *humiliation*; for prostration was ever the most eloquent sign of subjection. When it is said "our belly cleaveth unto the ground" (Psalm 44:25), it denotes such a prolonged prostration and such a depth of submission as could never be conveyed or expressed in literal words.

So with the other prophecy, "Dust shalt thou eat". This is not true to the letter, or to fact, but it is all the more *true to truth*. It tells of constant continuous disappointment, failure, and mortification; as when deceitful ways are spoken of as feeding on deceitful food, which is "sweet to a man, but afterward his mouth shall be filled with gravel" (Proverbs 20:17). This does not mean literal "gravel", but something far more disagreeable. It means *disappointment* so great that it would gladly be exchanged for the literal "gravel". So when Christians are rebuked for "biting and devouring one another" (Galatians 3:14,15), something more heart-breaking is meant than the literal words used in the Figure.

When "His enemies shall lick the dust" (Psalm 72:9) they will not do it on their knees with their literal tongues; but they will be so prostrated and so utterly defeated, that no words could literally depict their overthrow and subjugation.

If a serpent was afterward called a *nachash*, it was because it was more *shining* than any other creature; and if it became known as "wise", it was not because of its own innate positive knowledge, but of its wisdom in hiding away from all observation; and because of its association with one of the names

of Satan (that old serpent) who "beguiled Eve" (2Corinthians 11:3,14).

It is wonderful how a snake could ever be supposed to speak without the organs of speech, or that Satan should be supposed able to accomplish so great a miracle³

It only shows the power of tradition, which has, from the infancy of each one of us, put before our eyes and written on our minds the picture of a "snake" and an "apple" : the former based on a wrong interpretation, and the latter being a pure invention, about which there is not one word said in Holy Scripture.

Never was Satan's wisdom so craftily used as when he secured universal acceptance of this traditional belief: for it has succeeded in fixing the attention of mankind on the *letter* and the *means*, thus blinding the eyes to the solemn fact that the Fall of man had to do solely with the Word of God, and is centred in the sin believing Satan's lie instead of Jehovah's truth.

The temptation of " the first man Adam" began with the question "Hath God said ?" The temptation of "the second man, the Lord from heaven" began with the similar question "If thou be the Son of God", when the voice of the Father had scarcely died away, which said "This IS My beloved Son".

All turned on the truth of what Jehovah had said.

The Word of God being questioned, led Eve, in her reply, (1) to *omit* the word "freely" (3:2, compare 2:16); then (2) to *add* the words "neither shalt thou touch it" (3:3, compare 2:17); and finally (3) to *alter* a certainty into a contingency by changing "thou **SHALT SURELY** die" (2:17) into "**LEST** ye die" (3:3).

It is not without significance that the first Ministerial words of "the second Man" were "It is written", three times repeated; and that His last Ministerial words contained a similar threefold reference to the written Word of God (John 17:8,14,17).

The former temptation succeeded because the Word of God was three times misrepresented ; the latter temptation was successfully defeated because the same Word was faithfully repeated.

The history of Genesis 3 is intended to teach us the fact that Satan's sphere of activities is in the *religious* sphere, and not the spheres of crime or immorality; that his battlefield is not the sins arising from human depravity, but the *unbelief* of the human heart. We are not to look for Satan's activities today in the newspaper press, or the police courts ; but in the pulpit, and in professors' chairs. Wherever the Word of God is called in question, there we see the trail of "that old serpent, which is the Devil, and Satan". This is why anything against the true interests of the Word of God (as being such) finds a ready admission into the news-papers of the world, and is treated as "general literature". This is why anything in favour of its inspiration and Divine origin and its spiritual truth is rigidly excluded as being "controversial".

This why Satan is quite content that the *letter* of Scripture should be accepted in Genesis 3, as he himself accepted the letter of Psalm 91:11. He himself could say "It is written" (Matthew 4:6) so long as the *letter* of what is "written" could be put instead of the *truth* that is conveyed by it; and so long as it is misquoted or misapplied.

This is his object in perpetuating the traditions of the "snake" and the "apple", because it ministers to the acceptance of his lie, the hiding of God's truth, the support of tradition, the jeers of the infidel, the opposition of the critics, and the stumbling of the weak in faith.

NOTES :

¹ Ezekiel 28:11-19, who is quite a different being from "the Prince of Tyre", in verses 1-10 who is purely human.

² It is remarkable that the verb *nachash* always means to enchant, fascinate, bewitch; or of one having and using occult knowledge. See Genesis 30:27; 44:5,15. Leviticus 19:26. Deuteronomy 18:10. 1Kings 20:33. 2Kings 17:17; 21:6. 2Chronicles 33:6. So also is the noun used in Numbers 23:23; 24:1.

³ Greater than that wrought by God Himself, who opened the mouth of Balaam's ass.

"The Sons of GOD" in Genesis 6:2,4.

Appendix 23 From The Companion Bible.

It is only by the Divine specific act of creation that any created being can be called "a son of God". For that which is "born of the flesh is flesh". God is spirit, and that which is "born of the Spirit is spirit" (John 3:6). Hence Adam is called a "son of God" in Luke 3:38. Those "in Christ" having "the new nature" which is by the direct creation of God (2 Corinthians 5:17. Ephesians 2:10) can be, and are called "sons of God" (John 1:13. Romans 8:14,15. 1John 3:1).¹

This why angels are called "sons of God" in every other place where the expression is used in the Old Testament. Job 1:6; 2:1; 38:7. Psalms 29:1; 89:6. Daniel 3:25. (no article).² We have no authority or right to take the expression in Genesis 6:2,4 in any other sense. Moreover, in Genesis 6:2 the Septuagint renders it "angels".

Angels are called "spirits" (Psalm 104:4. Hebrews 1:7,14), for spirits are created by God.

That there was a fall of the angels is certain from Jude 6.

The nature of their fall is clearly stated in the same verse. They left their own οἰκητήριον (*oiketerion*). This word occurs only in 2Corinthians 5:2. Jude 6, where it is used of the spiritual (or resurrection) body.

The nature of their sin is stated to be "in like manner" to that of the subsequent sins of Sodom and

Gomorrha, Jude 7.

The time of their fall is given as having taken place "in the days of Noah" (1Peter 3:20. 2Peter 2:7), though there may have been a prior fall which caused the end of "the world that then was" (Genesis 1:1,2. 2Peter 3:6).

For this sin they are "reserved unto judgement", 2Peter 2:4, and are "in prison", 1Peter 3:19.

Their progeny, called *Nephilim* (translated "giants"), were monsters of iniquity; and being superhuman in size and character, had to be destroyed ([see Appendix 25](#)). This was the one and only object of the Flood.

Only Noah and his family had preserved their pedigree pure from Adam (Genesis 6:9 see note). All the rest had become "corrupt" (*shachath*) *destroyed* [as Adamites]. The only remedy was *to destroy it (defacto)*, as it had become *destroyed (de jure)*. (It is the same word in verse 17 as in verses 11,12.) See futher under [Appendix 25](#) on the *Nephilim*.

This irruption of fallen angels was Satan's first attempt to prevent the coming of the Seed of the woman foretold in Genesis 3:15. If this could be accomplished, God's Word would have failed, and his own doom would be averted.

As soon as it was made known that the Seed of the woman was to come through ABRAHAM, there must have been another irruption, as recorded in Genesis 6:4, "and also *after that*" (that is to say, after the days of Noah, more than 500 years after the first irruption). The aim of the enemy was to occupy Canaan in advance of Abraham, and so to contest its occupation by his seed. For, when Abraham entered Canaan, we read (Genesis 12:6) "the Canaanite was then (that is to say, already) in the land."

In the same chapter (Genesis 12:10-20) we see Satan's next attempt to interfere with Abraham's seed, and frustrate the purpose of God that it should be in "Isaac". This attempt was repeated in 20:1-18.

This great conflict may be seen throughout the Bible, and it forms a great and important subject of Biblical study. In each case the human instrument had his own personal interest to serve, while Satan had his own great object in view. Hence God had, in each case, to interfere and avert the evil and the danger, of which His servants and people were wholly ignorant. The following assaults of the great Enemy stand out prominently:-

The destruction of the chosen family by famine, Genesis 50:20.

The destruction of the male line in Israel, Exodus 1:10,15, etc. Compare to Exodus 2:5. Hebrews 11:23.

The destruction of the whole nation in Pharaoh's pursuit, Exodus 14.

After David's line was singled out (2Samuel 7), that was the next selected for assault. Satan's first assault was in the union of Jehoram and Athaliah by Jehoshaphat, notwithstanding 2Chronicles 17:1. Jehoram killed off all his brothers (2Chronicles 21:4).

The Arabians slew all his children, except Ahaziah (2Chronicles 21:17; 22:1).

When Ahaziah died, Athaliah killed "all the seed royal" (2Chronicles 22:10). The babe Joash alone was rescued; and, for six years, the faithfulness of Jehovah's word was at stake (2Chronicles 23:3).

Hezekiah was childless, when a double assault was made by the King of Assyria and the King of Terrors (Isaiah 36:1; 38:1). God's faithfulness was appealed to and relied on (Psalm 136).

In Captivity, Haman was used to attempt the destruction of the whole nation (Esther 3:6,12,13. Compare 6:1).

Joseph's fear was worked on (Matthew 1:18-20). Notwithstanding the fact that he was "a just man", and kept the Law, he did not wish to have Mary stoned to death (Deuteronomy 24:1); hence Joseph

determined to divorce her. But God intervened: "Fear not".

Herod sought the young Child's life (Matthew 2).

At the Temptation, "Cast Thyself down" was Satan's temptation.

At Nazareth, again (Luke 4), there was another attempt to cast Him down and destroy Him.

The two storms on the Lake were other attempts.

At length the cross was reached, and the sepulchre closed; the watch set; and the stone sealed. But "God raised Him from the dead." And now, like another Joash, He is *seated* and *expecting* (Hebrews 10:12,13), hidden in the house of God on high; and the members of "the one body" are hidden there "in Him" (Colossians 3:1-3), like another Jehoshaba; and going forth to witness of His coming, like another Jehoiada (2Chronicles 23:3).

The irruption of "the fallen angels" ("sons of God") was the first attempt; and was directed against the whole human race.

When Abraham was called, then he and his seed were attacked.

When David was enthroned, then the royal line was assailed.

And when "the Seed of the woman" Himself came, then the storm burst upon Him.

NOTES

¹ The word "offspring" in Acts 17:28 is quite different. It is **Γένος** (*genos*), which means merely *kin* or *kind*, our *genus* as being originated by God.

² In Hosea 1:10, it is not *beni-ha-Elohim*, as here, but *beni-el-chai*.

The *N^ephilim*, or "Giants" of Genesis 6, etc.

Appendix 25 From The Companion Bible.

The progeny of the fallen angels with the daughters of Adam (see notes on Genesis 6, and Appendix 23 are called in Genesis 6, *N^e-phil'im*, which means *fallen ones* (from *naphal*, to fall). What these beings were can be gathered only from Scripture. They were evidently great in size, as well as great in wickedness. They were superhuman, abnormal beings; and their destruction was necessary for the preservation of the human race, and for the faithfulness of Jehovah's Word (Genesis 3:15).

This was why the Flood was brought "upon the world of the ungodly" (2Peter 2:5) as prophesied by Enoch (Jude 14).

But we read of the *N^ephilim* again in Numbers 13:33 : "there we saw the *N^ephilim*, the sons of Anak, which come of the *N^ephilim*". How, it may be asked, could this be, if they were all destroyed in the Flood ? The answer is contained in Genesis 6:4, where we read: "There were *N^ephilim* in the earth in those days (that is to say, in the days of Noah); and also **AFTER THAT**, when the sons of God came in unto the daughters of men, and they bare children to them, the same became [the] mighty men (Hebrew

gibbor, the heroes) which were of old, men of renown" (literally, *men of the name*, that is to say, who got a name and were renowned for their ungodliness).

So that "after that", that is to say, after the Flood, there was a *second* irruption of these fallen angels, evidently smaller in number and more limited in area, for they were for the most part confined to Canaan, and were in fact known as "the nations of Canaan". It was for the destruction of these, that the sword of Israel was necessary, as the Flood had been before.

As to the date of this second irruption, it was evidently soon after it became known that the seed was to come through Abraham; for, when he came out from Haran (Genesis 12:6) and entered Canaan, the significant fact is stated: "The Canaanite was then (that is to say, *already*) in the land." And in Genesis 14:5 they were already known as "Rephaim" and "Emim", and had established themselves as Ashteroth Karnaim and Shaveh Kiriathaim.

In chapter 15:18-21 they are enumerated and named among Canaanite Peoples: "Kenites, and the Kenizzites, and the Kadmonites, and the Hittites, and the Perizzites, and the Rephaims, and the Amorites, and the Girgashites, and the Jebusites" (Genesis 15:19-21; compare Exodus 3:8,17; 23:23. Deuteronomy 7; 20:17. Joshua 12:8).

These were to be cut off, and driven out, and utterly destroyed (Deuteronomy 20:17. Joshua 3:10). But Israel failed in this (Joshua 13:13; 15:63; 16:10; 17:18. Judges 1:19,20,28,29,30-36; 2:1-5; 3:1-7); and we know not how many got away to other countries to escape the general destruction. If this were recognized it would go far to solve many problems connected with Anthropology.

As to their other names, they were called *Anakim*, from one Anak which came of the *N^e philim* (Numbers 13:23), and *R^e phaim*, from Rapha, another notable one among them.

From Deuteronomy 2:10, they were known by some as *Emim*, and *Horim*, and *Zamzummim* (verse 20,21) and *Avim*, etc.

As *R^e phaim* they were well known, and are often mentioned: but, unfortunately, instead of this, their proper name, being preserved, it is variously translated as "dead", "deceased", or "giants". These *R^e phaim* are to have no resurrection. This fact is stated in Isaiah 26:14 (where the proper name is rendered "deceased", and verse 19, where it is rendered "the dead").

It is rendered "dead" seven times (Job 26:5. Psalm 88:10. Proverbs 2:18; 9:18; 21:16. Isaiah 14:8; 26:19).

It is rendered "deceased" in Isaiah 26:14.

It is retained as proper name "*R^e phaim*" ten times (two being in the margin). Genesis 14:5; 15:20. Joshua 12:15 (margin). 2Samuel 5:18,22; 23:13. 1Chronicles 11:15; 14:9; 20:4 (margin). Isaiah 17:5.

In all other places it is rendered "giants", Genesis 6:4, Numbers 23:33, where it is *N^e philim*; and Job 16:14, where it is *gibbor* ([Appendix 14. iv](#)).

By reading all these passages the Bible student may know all that can be known about these beings.

It is certain that the second irruption took place before Genesis 14, for there the *R^e phaim* were mixed up with the five nations or peoples, which included Sodom and Gomorrha, and were defeated by the four kings under Chedorlaomer. Their principal locality was evidently "Ashtaroth Karnaim"; while the *Emim* were in the plain of Kiriathaim (Genesis 14:5).

Anak was a noted descendant of the *N^e philim*; and *Rapha* was another, giving their names respectively to different clans. Anak's father was *Arba*, the original builder of Hebron (Genesis 35:27. Joshau 15:13; 21:11); and this Palestine branch of the *Anakim* was not called *Abraham* after him, but *Anakim* after Anak. They were great, mighty, and tall (Deuteronomy 2:10,11,21,22,23; 9:2), evidently inspiring the ten spies with great fear (Numbers 12:33). Og king of Bashan is described in Deuteronomy 3:11).

Their strength is seen in "the giant cities of Bashan" to-day; and we know not how far they may have been utilized by Egypt in the construction of buildings, which is still an unsolved problem.

Arba was rebuilt by the *Khabiri* or confederates seven years before Zoan was built by Egyptian Pharaohs of the nineteenth dynasty. See note on [Numbers 13:22](#).

If these *N^e philim*, and their branch of *R^e phaim*, were associated with Egypt, we have an explanation of the problem which has for ages perplexed all engineers, as to how those huge stones and monuments were brought together. Why not in Egypt as well as in "the giant cities of Bashan" which exist, as such, to this day?

Moreover, we have in these mighty men, the "men of renown," the explanation of the origin of the Greek mythology. That mythology was no mere *invention* of the human brain, but it grew out of the traditions, and memories, and legends of the doings of that mighty race of beings; and was gradually evolved out of the "heroes" of Genesis 6:4. The fact that they were supernatural in their origin formed an easy step to their being regarded as the demi-gods of the Greeks.

Thus the Babylonian "Creation Tablets", the Egyptian "Book of the dead", the Greek mythology, and heathen Cosmogonies, which by some are set on an equality with Scripture, or by others adduced in support of it, are all the corruption and perversion of primitive truths, distorted in proportion as their origin was forgotten, and their memories faded away.

INDEX

[\[Christian Links\]](#)



The Two Great Prophecies

of "The End of the Age"

(Luke 21, and Matthew 24, Mark 13).

This Is Appendix 155 From The Companion Bible.

The great prophecy recorded in Luke 21 is different both in *time, place* and *subject* from that recorded in Matthew 24 and Mark 13.

The one recorded in Luke was spoken "on one of those days, as He taught the people *in the Temple*" (Luke 20:1). For one note of time is in 21:1, "and He looked up and saw the rich men casting their gifts *into the Treasury.*" So that He was still "in the Temple" when He uttered the prophecy recorded in Luke 21, for the whole conversation with the disciples follows without a break the Lord's commendation of the widow.

But with regard to the prophecy recorded in Matthew 24, we distinctly read (verse 1) "and Jesus went out and departed *from the Temple* ... and *as He sat upon the Mount of Olives*, the disciples came to Him privately" (verse 3). So in Mark 13:1, "He *went out of the Temple* ... and *as he sat upon the Mount of Olives, over against the Temple*, Peter and James and John and Andrew asked Him privately" (verse 3).

So that we have *two* great prophecies. One (Luke) spoken in the Temple, the other (Matthew and Mark) spoken *later* upon the Mount of Olives. As parts of the first are repeated on the second occasion, we will give the leading points of the three in parallel columns, so that the object of each, and the difference between them, may be clearly seen.

They both open with a summary of events which might have taken place in the lifetime and experience of those who heard the words :

From The Cross, Onwards.

LUKE 21:8-9.	MATTHEW 24:4-6	MARK 13:5-7
--------------	----------------	-------------

<p>"Take heed that ye be not deceived: for many shall come in My name, saying, I am Christ; and the time draweth near: go ye not therefore after them. But when ye shall hear of wars and commotions, be not terrified: for these things must first come to pass; but the end is not by and by (that is to say, immediatel; so Revised Version)."</p>	<p>"Take heed that no man deceive you. For many shall come in My name, saying I am Christ; and shall deceive many. And ye shall hear of wars and rumours of wars: see that ye be not troubled: for all these things must come to pass, but the end is not yet."</p>	<p>"Take heed lest any man deceive you. For many shall come in My name, saying, I am Christ; and shall deceive many. And when ye shall hear of wars and rumors of wars, be ye not troubled: for such things must needs be; but the end shall not be yet."</p>
--	--	--

John refers to this first sign in his First Epistle (2:18); but had the nation repented at the proclamation by Peter in Acts 3:18-26, by the Twelve in the Land, by "them that heard Him" (Hebrews 2:3), and by Paul in the Synagogues of the Dispersion, "all that the prophets had written" would have been fulfilled.

LUKE 21:10,11.	MATTHEW 24:7,8.	MARK 13:8.
<p>"Nation shall rise against nation and kingdom against kingdom: and great earthquakes shall be in divers places, and famines, and pestilences, and fearful sights and great signs shall there be from heaven."</p>	<p>"Nation shall rise against nation, and kingdom against kingdom; and there shall be famines, and pestilences, and earthquakes, in divers places. All these are the beginning of sorrows."</p>	<p>"Nation shall rise against nation, and kingdom against kingdom; and there shall be earthquakes in divers places, and there shall be famines and troubles: these are the beginnings of sorrows."</p>

Now, it will be observed in the Lord's discourse as recorded in Luke, that, instead of saying "these are the beginning of sorrows", and going on with the account of them, He stops short; He goes back; He introduces a parenthesis detailing and describing events that

would take place "**BEFORE ALL THESE**" beginnings of sorrows. He describes in verse 12,

THE DESTRUCTION OF JERUSALEM.

<p>12. But before all these, that is to say "BEFORE" the great tribulation, all that is recorded concerning Jerusalem in verses 12-24 would take place. These are the closing words :</p>		
<p>24. "And they shall fall by the edge of the sword, and shall be led away captive into all nations: and Jerusalem shall be trodden down of the Gentiles, until the times of the Gentiles be fulfilled."</p>		

Now, in the discourse recorded in Matthew 24, instead of going back to speak of the condition of Jerusalem before and until the beginning of the great Tribulation; having said "All these are the beginning of sorrows", He *goes on to describe* the sorrows, or birth-pangs of the Tribulation (Matthew 24:9-28. Mark 13:9-23), and He continues the prophecy concerning these sorrows up to the moment of His appearing in the clouds of heaven.

While, in the discourse recorded in Luke 21, having gone back, and described what should take place "before all these" beginnings of sorrows, the Lord does not speak further of the great Tribulation, but takes it up at the end, and, as in Matthew and Mark, speaks concerning,

HIS COMING IN THE CLOUDS OF HEAVEN

(of course, in Luke the words are slightly different from those in Matthew and Mark)

LUKE 21:25-27.	MATTHEW 24:29, 30.	MARK 13:24-26.
<p>"And there shall be signs in the sun, and in the moon, and in the stars; and upon the earth distress of nations, with perplexity; the sea and the waves roaring; men's hearts failing them for fear, and for looking after those things which are coming on the earth; for the powers of the heavens shall be shaken. And then shall they see the Son of man coming in a cloud with power and great glory."</p>	<p>"IMMEDIATELY after the tribulation of those days ¹ shall the sun be darkened, and the moon shall not give her light, and the stars shall fall from heaven, and the powers of the heavens shall be shaken: and then shall appear the sign of the Son of man in heaven: and then shall all the tribes of the earth mourn, and they shall see the Son of man coming in the clouds of heaven with power and great glory."</p>	<p>"But in those days, after that tribulation ¹, the sun shall be darkened, and the moon shall not give her light, and the stars of heaven shall fall, and the powers that are in heaven shall be shaken, and then shall they see the Son of man coming in the clouds with great power and glory."</p>

The **first** prophecy, in the Temple (Luke 21), was uttered in answer to **two** questions : (1) "When shall these things be?" and (2) "What sign shall there be when these things shall come to pass?" The answer to (1) is given in verses 8-24, and the answer to (2) in verses 25-28.

The **second** prophecy, on the Mount of Olives (Matthew 24 and Mark 13), was uttered in answer to **three** distinct questions : (1) "When shall these things be?" (2) "What shall be the sign of Thy coming?" and (3) "And [what shall be the sign] of the end of the age?" The answer to (1) was given in Matthew. 24:4-14. Mark 13:5-13. The answer to (2) was given in Matthew 24:15-27. Mark 13:14-23; and to (3) in Matthew 24:29-31 and Mark 13:24-27 (and in Luke 21:25-28).

And then both prophecies conclude with the Parable of the Fig tree, and the final solemn assurance :-

"Verily I say unto you, This generation shall by no means (See [Appendix 105. III](#)) pass, till all these things may be fulfilled" ² (Matthew 24:34. Mark 13:30. Luke 21:32.)

This latter is the last of four equally impressive statements : Matthew 10:23; 16:28; 23:39; 24:34.

Each of these consists of two clauses, the former of which contains the strongest negative that could possibly have been used (see [Appendix 105. III](#)); and should be rendered "by no means", or "in no wise", as it is often rendered elsewhere; while in the latter clause the verb is in the subjunctive mood with or without the Greek Particle "*an*", which (though it cannot be represented in translation) makes the clause hypothetical and dependent on some condition expressed or implied. This condition was, in each of these four passages, the repentance of the nation, in response to the appeal of "the other servants" of Matthew 22:4, as recorded in Acts 3:18-26 and elsewhere, culminating in Acts 28:17-29.

The conclusion of both prophecies thus consists of an assured *certainty*, with a definite contingency, or *uncertainty* which was not fulfilled.

Had the nation repented, then Jesus Christ would have been "sent", and "the restoration of all things which God had spoken by all His holy prophets since the world began" would have taken place, in accordance with God's Divine assurance given by Peter in Acts 3:18-26; but the condition of national repentance (Leviticus 26:40-42; Hosea 14:1-4, etc.) was not fulfilled; hence that generation passed away; and both prophecies (with all the others) are now *postponed*. The first sign of all did (and will again) take place - the rising of the "many Antichrists", whereby John could say they knew that it was "the last hour" before "the end of that age" (1 John 2:18).

NOTES

¹ Leaving no space, therefore, for a millennium of peace between the great Tribulation and the appearance of the Lord in glory; proving that the second coming must be pre-millennial.

² In all three passages the verb is *genetai* = may arise, or may have come to pass: not *pleroo* = be entirely fulfilled or finished, as in Luke 21:24. This was so in both cases.

[Back to Christian Links](#)

[Back to Index](#)

[Home](#)

This webpage has been modified for content from the original. Many thanks to Pastor Lancelot Knight (also a student of Pastor Arnold Murray of the Shepherd's Chapel, Gravette, Arkansas) and appears on his website, at - <http://www.kingschapel.org>

SIGNS in the Heavens

Did you know that there would be SIGNS in the heavens, just preceding the return of Jesus Christ? Jesus said so Himself in Luke 21 as part of His answer to His disciple's question concerning what signs to look for before He returns, "[vs. 7] and what SIGN will there be when these things shall come to pass?" Jesus said:

Luke 21:25

And there shall be signs in the sun, and in the moon, and in the stars; and upon the earth distress of nations, with perplexity; the sea and the waves roaring;

What is a "sign" anyway? The Greek word is semaino, say-mah'-ee-no, Greek #4591; from sema (a mark; of uncertain derivative); to *indicate* :- signify.

So a "sign" is an indicator of something, a signal, but of what? You see, there needs to be an understanding between the sign "giver" and the sign "receiver" as to what the sign will be and what it means when it is given. Here's an example:

Suppose it is April of the year 1775 and you are sitting on your back porch in Lexington just listening to the crickets crick and watching the night crawlers crawl. Suddenly you look up at the steeple of the Old North Church and you see a single light and you say to yourself, "I never saw a light in the tower before. It must be a couple of kids with a lantern playing around."

The fact is, you didn't even give it a thought that that light might be a "sign", and furthermore, never in your wildest dreams would you think that such a light was a very profound signal that would end up saving lives and then be recorded in the history books as a famous event!

But suppose your name was Paul Revere and you looked up and saw a Single Light in the Steeple. "Oh my goodness!", you would say, as you throw down your copper bottomed pots and pans, and jump on your horse, and ride as fast as you can through the towns and countrysides WARNING your people that the British are coming by LAND. You KNEW what that SIGN meant... "One if by Land... Two if by Sea." And you WATCHED for it,

and when you saw the sign, you went forth and sounded the alarm! Got the picture?

Do you see the difference among the people? Paul Revere knew what "sign" to look for along with the code, while the others didn't even recognize that a sign was being given, for they hadn't read the script(ures), so to speak.

Now, we Christians living in this final generation of the "fig tree" have been given instructions by Jesus Christ, as well as the apostles Paul, Peter, John, and the prophets of old to WATCH. We are to be like Paul Revere, and KNOW the signs, the signals, and their meanings and when we SEE them in action, we are to WARN our people.

Let us begin with the "signs in the sun, in the moon, and in the stars." By the way, the word "stars" in the Greek is *astron*, as'tron, Greek #798 in Strong's Concordance. It means "properly a constellation". Jesus said there would be signs in the "stars", i.e. the "constellations", and we recently saw a massive sign in the constellation Leo, which we will learn about following our disclosure of some background information. This is really exciting! Imagine seeing the prophecies of Jesus Christ unfold right before our very eyes. It is happening!

Our Father has given us a very large set of SIGNS, ones we CANNOT MISS SEEING! And He gave them to us right from the very beginning:

Genesis 1:14

And God said, Let there be lights in the firmament of the heaven to divide the day from the night; and let them be for signs, and for seasons, and for days, and years:

[15] And let them be for lights in the firmament of the heaven to give light upon the earth: and it was so.

[16] And God made two great lights; the greater light to rule the day, and the lesser light to rule the night: he made the stars also.

On Wednesday, November 17th, 1999, scientists and astronomers and WATCHMEN witnessed a dramatic event in the heavens, which was especially spectacular over the Middle East. It had to do with the stars and we will document that it was indeed a SIGN in the heavens spoken of in the prophecy of Jesus Christ that we just read in Luke 21:25. He wasn't kidding about seeing signs! They are HERE!

Can you believe it?... Have you considered it?... The fact that we are living in the most exciting time in the history of the world, the time of the end, the last days that the prophets wrote of, and the time that the apostles longed to see. Therefore be thankful, for we are most privileged and blessed by our Father to be here now to witness "all these things that must shortly come to pass!"

Let's learn about the heavens. Here are some excerpts from Appendix 12 in the Companion Bible. (If you are fortunate to have a Companion Bible, then you would do well to read the entire appendix 12 and become familiar with the plan of God in the uncorrupted Zodiac. It is this knowledge that is key to understanding what happened on Nov. 17th.)

"In the first mention of the heavenly bodies, the purpose of the Creator is clearly stated. Gen. 1:14-19 reveals the fact that they were created, not only "to divide the day from the night, and to give light upon the earth"; but, they were set "for SIGNS, and for SEASONS, and for days and years."

They are "for SIGNS".

Heb. *oth*, from *athah*, *to come*. Signs, therefore, of something or some One *to come*. Those who understand them are enlightened by them. Those who do not may well be "dismayed" (Jer. 10:2).

The stars are numbered and named, There are twelve signs of the Zodiac, called "the stars" in Gen. 37:9 (eleven of which bowed down to Joseph's, the twelfth.) The word ZODIAC means the *degrees* or *steps*, which mark the stages of the sun's path through the heavens, corresponding to the twelve months.

The stars were all named by God (Ps. 147:4). Most of these names have been lost; but over 100 are preserved through the Arabic and Hebrew, and used by astronomers today, though their meaning is unknown to them....

These names and the twelve "signs" go back to the foundation of the world..."

Did you know that the entire plan of God is written in the stars, in the 12 Signs of the Zodiac? Of course Satan has corrupted and debased God's true astrological blueprints, just as he has His true Word. In fact, many Christians today believe the Zodiac itself is evil because they associate it with the idiots who try to tell you how your love life will fare tomorrow based on your "sign". Nevertheless, before the written Word was complete, the plan of God was written in the stars and understood then and now by the wise men and women of God.

Here is some more background information on the Zodiac.

"The fact that the signs of the zodiac bear little resemblance to the pictures associated with them should be of great interest to observers of the night-time sky. Every ancient culture with any knowledge or tradition concerning the stars recognizes the same 12 star groups and the same names or meanings of names. Examine the star knowledge of whatever ancients you choose (Babylonia, China, India, Persia, Egypt, Greece, Rome, Central America...) and everywhere the same constellations are identified and associated with the

identical or similar meanings and names.

"The 12 signs as originally given by God were a prophetic outline of the purpose of God in the history of salvation. They are understood, however, only if they are seen in their proper order. Since they form a circle, the problem is in knowing where to begin and finish. Astrologers begin with Aries, but this does not correspond with Biblical revelation. A comparison of the prophecies in the heavens with the prophecies in the Bible clearly shows that the starting point is the divine promise concerning the seed of the woman (Genesis 3:15), and the ending point clearly coincides with the climax of scripture in the triumph of the Lion of the tribe of Judah (Jesus Christ) - (Revelation 5:5).

"The promise of the Seed in the first book of the Bible (Genesis) is seen in the constellation Virgo (the woman). The promise of the triumphant Lion, seen in the last book of the Bible is displayed in Leo. So the outline begins with Virgo and ends with Leo. Confirmation of this is found in one of the very old Zodiacs dating back to 2000 BC or before. It is called the zodiac of Denderah and was found on the ceiling of the portico of the temple of Esneh in Egypt. In this Zodiac there is placed between the signs of Virgo and Leo a picture of the Sphinx. The Sphinx (with the head of a woman and the tail of a lion) confirms the starting and finishing points for the Zodiac. Many scholars think that this was in fact the main purpose of the Sphinx and thus solves its "riddle". (Zodiac Signs and Bible Truth, The International Christian Network Church.)



The following information [except for my notes in brackets] can be obtained from any encyclopedia (note the numerics of multiples of 6 in the dimensions. 6 is the "human number", for man was created on the 6th day.):

The Sphinx is not built with quarried blocks like the pyramids and the temples it guards, but is rather carved out of bedrock. It has a woman's head (some say it's a man) and the body of a lion. It is 66' high [66 is the number of books in the Bible] and an impressive 240' long [which is 6 40s, i.e. six probationary periods of man, or 6,000 years from the beginning of Virgo to the end of Leo]. It faces the distant horizon due east, at the equinox

point.

We must move along with our study, but even though we have covered a great deal of background information even to this point, believe it or not we have only scratched the surface of the depth of credible information available to us concerning the Bible in the stars, the Bible in Stone, i.e. the Great Pyramid of Giza, etc. If you would like to read and study more on these subjects, we suggest the following books:

"Witness of the Stars", E.W. Bullinger

"The Great Pyramid Decoded", E. Raymond Capt

"Glory of the Stars", E. Raymond Capt

We will learn about the SIGN that occurred in Leo on Nov. 17 and understand the meaning thereof. However, there is still some necessary background information that we must know because as we said, the SIGN occurred in the constellation Leo. Here is what the Sign of Leo denotes:

LEO. The Lion. Messiah's consummated triumph. In the Zodiac of Denderah it is *Pi Mentikon* = pouring out (of Divine wrath). The three constellations crystallize the truth.

1. Hydra = the old serpent destroyed.
2. Crater = the cup of wrath poured out on him.
3. Corvus = the bird of prey devouring him.

(Appendix 12, The Companion Bible)

We all saw witness of the "Fireworks" that our Father set off in the Constellation Leo on Nov. 17th. What a show He put on! What a SIGN He gave to us!

Our Father had a purpose and a plan when He made the Sun, the Moon, and the Stars, and that He organized them and set them in the heavens to be not only time pieces marking the days, months, years, etc. but also as an outline of the plan of His salvation for mankind and the marking of "things to come", i. e. the "appointed times" (cp. Gen. 17:21, 18:14, 21:2). We therefore have a second witness in the Heavens to the Word of God and the prophecies contained therein, for they are both the handiwork of the Lord and they totally agree in harmony.

We also learned in our study that the plan of salvation begins in Virgo, the woman, with the promise of her seed, the Child who would be born. Here is the description of that promise, as seen in the HEAVENS, and recorded by John in the Book of Revelation:

Rev. 12:1-2

And there appeared a great wonder in heaven; a woman clothed with the sun, and the moon under her feet, and upon her head a crown of twelve stars:

Look up the word "wonder" in your Strong's Concordance. It means "sign" and is most often translated that way.

[2] And she being with child cried, travailing in birth, and pained to be delivered.

Yes, the seed, the child, the One who would be born of the Virgin (Virgo) that would bruise the head of the Serpent, just as it is recorded harmoniously in Gen. 3:15. Here are the words of the Lord [I] to the Serpent [thee]:

Genesis 3:15

And I will put enmity between thee and the woman, and between thy seed and her seed; it shall bruise thy head, and thou shalt bruise his heel.

Do you see it? Even before man was created in the flesh, the stars declared His plan and His glory. And that Child was later brought forth, the very King of kings and Lord of lords who will be the One to rule all nations, though He was first born lowly and laid in a manger, and His heel was bruised by the serpent as the nail was driven into it, and He was crucified and caught up to sit at the right hand of the Father, which is where He is now.

Rev. 12:5

And she brought forth a man child, who was to rule all nations with a rod of iron: and her child was caught up unto God, and to his throne.

Now it is also written that after Jesus was tempted in the wilderness He told Satan to "get behind Him" and that is where he is even now, for he has since been restricted from freely roaming the earth "in person", and is currently being restrained by Michael and his angels. So neither Jesus Christ nor Satan are presently here on earth in person, but Satan's evil spirit is ever-present just as the Holy Spirit is present.

But guess what? They are both returning IN PERSON! But beware lest any man deceive you! Satan, the dragon, that old serpent, comes FIRST, at the sound of the 6th Trump. And when he comes he will be disguised as Jesus Christ Himself and the whole world will wonder after him. He will sit in the temple and show the world through signs and miracles in the sight of men that he is God. (2 Thes. 2). This will happen when Michael casts him out of heaven, when "he who letteth is taken out of the way" (2 Thes. 2:7). Here is the account in Revelation of this soon to occur event:

Rev. 12:7

And there was war in heaven: Michael and his angels fought against the dragon; and the dragon fought and his angels,

War in heaven? I thought heaven was a peaceful, serene paradise? It is where our Father resides, but across the gulf (Luke 16) there are trouble makers and those who didn't "make it". Michael has Satan and his right hand goons in a restricted confine. And don't think that Satan and his angels are any match for the mighty Michael. He "man handles" them with ease so that they cannot prevail.

[8] And prevailed not; neither was their place found any more in heaven.

Satan is such a loser! And his time is soon up!

[9] And the great dragon was cast out, that old serpent, called the Devil, and Satan, which deceiveth the whole world: he was cast out into the earth, and his angels were cast out with him.

Any question about who the serpent in the garden of Eden was? He was the beautiful archangel, Satan, the description of whom you can read about in Ezek. 28. Of course he's a snake and a low-life, figuratively speaking.

But look what happens! Not only Satan is cast out, but his **angels** are cast out with him. These angels are the same "fallen stars", the Nephilim of Genesis chapter 6, who left heaven (their first habitation as described by Jude in verse 6) and came to earth in their angelic bodies instead of being born of woman. They took to wife the daughters of Adam and the union between flesh and angelic bodies produced giants, "gibor" in Hebrew. It was because of these giants that God brought the flood of Noah upon the land.

Well, they are coming again, those fallen angels, just as they did in the days of Noah. Jesus Christ said so:

Matthew 24:37-38

But as the days of Noe were, so shall also the coming of the Son of man be.

We better know exactly what happened in the days of Noah if we want to know what's coming our way, right? We are reminded by Christ what they did.

[38] For as in the days that were before the flood they were eating and drinking, marrying and giving in marriage, until the day that Noe

entered into the ark,

Yep, the nephilim, Satan's angels, are coming again when they and their commander in chief, Satan, are cast out of heaven by Michael.

And when they are cast out of heaven, the folks that dwell in heaven will be rejoicing that Satan and his creeps are gone. But WOE to the inhabitants of the earth (that's us flesh folk). Fun, fun, fun! Get ready.

Rev. 12:12

Therefore rejoice, ye heavens, and ye that dwell in them. Woe to the inhabitants of the earth and of the sea! for the devil is come down unto you, having great wrath, because he knoweth that he hath but a short time.

The apostle Paul also records that Satan is restrained right now, but that he will soon be released and come to this earth posing as God, i.e. Jesus Christ. That is what anti-christ means, "instead-of-Christ". Here is Paul's account in 2 Thes. concerning the coming of the son of perdition, who will stand in the holy place claiming to be the Messiah.

2 Thes. 2:6

And now ye know what withholdeth that he might be revealed in his time.

You should know what is holding up Satan. We just read it in Rev. 12:7. It's Michael.

2 Thes. 2:7

For the mystery of iniquity doth already work: only he who now letteth will let, until he be taken out of the way.

The rapture theorists interpret this verse as meaning the Holy Spirit [he] will be taken away from the earth when the goody-two-shoes Christians are snatched into the clouds. However, there is a transitive verb in this verse that negates such nonsense. Let's read the next two verses and then we'll clear it up.

[8] And then shall that Wicked be revealed, whom the Lord shall consume with the spirit of his mouth, and shall destroy with the brightness of his coming:

The Wicked one is Satan, the dragon, whom the Lord shall destroy at His second coming.

Let's read these same verses in the Living Bible which has them translated a little clearer for us. (If you have a Companion Bible read the notes corresponding to these verses.)

2 Thes. 2:6

And you know what is keeping him from being here already; for he can only come when his time is ready.

[7] As for the work this man of rebellion and hell will do when he comes, it is already going on, but he himself will not come until the one who is holding him back steps out of the way.

We already know who has him restrained and will cast him out, Michael (Rev. 12:7-9).

[8] Then this wicked one will appear, whom the Lord Jesus will burn up with the breath of His mouth and destroy by His presence when He returns.

Now we are getting somewhere! Jesus Christ, the One who was brought forth who will rule the nations with a rod iron, will crush the head of the Serpent, Satan, at His presence, when He returns at the 7th Trump!

This all happens in the SIGN OF LEO! Remember the three constellations in Leo from earlier;

1. Hydra = the old serpent destroyed
2. Crater = the cup of wrath poured out
3. Corvus = the birds of prey devouring him

Let's now read what happened on Nov. 17th, 1999, and then we will begin to explain the significance of it.

First, here are some quotes from the Ha'aretz News in Jerusalem from Thursday, November 18, 1999 (the underlining is mine):

Scientists here for 'shooting star'-spangled skies

By Tamara Traubman,

"An international galaxy of scientists last night were poised in the observatories at Mitzpeh Ramon in the Negev and at Tel Aviv University to observe a meteor shower that one visiting astronomer from the U.S. Space Agency NASA called "one of the rarest sights we have ever seen."

The spectacular shower of so-called "Leonid" meteors - because they appear to radiate from a point in the constellation of LEO - was to reach its peak at 4 A.M. Thursday,

streaking across the sky at a rate of about 1,000 meteors an hour (though the peak period lasts only a few minutes).

In addition to NASA, teams from the U.S. Air Force, Canada and Holland joined their colleagues from the Israeli Space Agency to watch the heavenly spectacle.

Col. Pete Warden of the U.S. Air Force said about \$2.5 million had been invested to document the event.

A NASA astronaut said that "we won't have another opportunity like this for the next 100 years."

A meteor is a streak of light in the sky caused by a meteoroid passing through the earth's atmosphere; in popular parlance, it is known as a "shooting star." Meteoroids are often lumps of rock or iron and orbit the sun like planets, moving at extremely high speed.

Meteoroids that enter the upper atmosphere of the planet are heated by air resistance, causing gases around the meteoroids to glow and producing meteors.

The Leonids in the current shower did not land on earth because they were burned and disintegrated. However, the dust particles could disrupt the activity of some of the hundreds of satellites currently orbiting the earth.

It is this aspect of the phenomenon - the danger that meteors pose to artificial satellites - that is of particular interest to the U.S. Air Force.

At 12:30 A.M. two NASA research aircraft lifted off from Ben-Gurion Airport to study the meteors. Radar and other instruments placed at Kibbutz Revivim in the Negev and near Mount Hermon in the north supplied information about the meteors' chemical structure and their temperature.

One possibility being examined is that the meteoroids carry organic material. According to one theory, organic material borne by heavenly bodies that struck the earth's surface billions of years ago may have created part of the conditions necessary for the emergence of life on the planet."

If you are fortunate to have eyes to see and ears to hear, this article is filled with in-depth goodies, some of which we will analyze later.

Next, here are some quotes from the article on the BBC News, UK, Thursday, November 18, 1999, published at 11:27 GMT (again, the underlining is mine):

Sci/Tech

World marvels at meteors

Waves of fireballs brightened the skies over the Middle East as the much-heralded Leonid meteor shower swelled into the heaviest show of shooting stars in 33 years.

Around the world, astronomers and amateur stargazers gathered together to watch the celestial light show, which is unlikely to be matched for decades...

In Jordan, 25 miles from the border with Saudi Arabia, about 50 astronomers from around the world watched as fireballs flashed over the desert.

Jordanian astronomer Ali Abanda, said; "It is magnificent. It is something that we didn't even detect when we watched the skies 33 years ago."

In Israel, observers in the Jordan Valley marveled at the canopy of shooting stars. Ariel Cohen, professor of atmospheric sciences at Hebrew University, said "I see this as nature's contribution to the celebration of the new millennium."

"Streak of light"

The Leonids, which get their name because they appear to come from the constellation Leo, occur when the Earth passes through the dusty debris left by comet Temple-Tuttle.

The show is usually at its best just after the comet has visited the inner Solar System - something it did early last year. Here, the sun's heat warms the comet's ice and loosens the dusty fragments which become meteors.

Around the globe, military and private companies turned satellite solar panel side-on to the shower to avoid the meteor strikes.

However, one country which did not enjoy a dazzling display was Britain, where bad weather hampered views of the Leonids.

Scientist John McFarland said; "It is a disappointment, but we are at the mercy of the elements. It's been overcast all night and I haven't been able to see anything at all."

Yes, it was a spectacular display of "falling stars" over the Middle East and around the world, and it was a SIGN in the constellation Leo for those who have eyes to see and ears to hear. We could do an entire study on each of the underlined statements in these two news articles, like Britain, "B'rith-ain", meaning

"covenant-land", did not see the dazzling display because of bad weather! "We are at the mercy of the "elements" (read "rudiments" from 2 Pet. 3:12), etc.

Now you know what happened on Nov. 17th, 1999, and we will soon discuss the full significance of what it all means. Yes, there is much more to come!

Now that we know about the spectacular Leonid "light show" and "fireworks display" that took place on Nov. 17, 1999, which was especially intense over the Middle East, we will next document that the Leonids do indeed have a profound "religious" significance, which is extremely important to our understanding of the SIGN.

There are numerous resources you can access using the technology available in this information age to research the history of the Leonids. What we will focus on is the Leonid shower of Nov. 17, 1883, which was especially intense over the Western Hemisphere. Here are some quotes from the website http://www.leonids.com/1833/the_1833_storm.html titled "The 1883 Storm":

The 1833 Storm

Meteor Showers were neither known nor understood during the first half of the 19th Century. Thus, when Americans awoke during the twilight hours on November 17th, 1833, many thought Judgment Day had finally arrived.

The Leonids are credited with playing a large role in the religious renaissance that took place in America in the 1830s. Perhaps Yale professor Denison Olmstead, who scrutinized the 1833 Storm and laid the foundations of modern meteorics, the study of meteors, put it best:

"Probably no celestial phenomenon has ever occurred in this country, since its first settlement, which was viewed with so much admiration and delight by one class of spectators, or with so much astonishment and fear by another class."

What follows is a gallery of images - graciously provided by astronomer and meteoricist Ron Oriti- and various period-accounts of the 1833 Leonid Meteor Storm, attempting to offer as close a perspective as possible to what people experienced that fateful night.



There is more information and pictures available if you wish to visit the website.

The following are quotes from the "Sky & Telescope" magazine, a reputable publication in the field of astronomy. Their website is <http://www.skypub.com/sights/meteors/leonids/king.html>

Leonid History

On the night of November 12, 1833, the Western Hemisphere unexpectedly came under attack. A firestorm of shooting stars, silent but overwhelming, filled the sky. Here is a part of Victorian astronomy writer Agnes Clerke's classic description of that incredible scene:

"On the night of November 12-13, 1833, a tempest of falling stars broke over the earth... the sky was scored in every direction with shining tracks and illuminated with majestic fireballs. At Boston, the frequency of meteors was estimated to be about half that of flakes of snow in an average snowstorm. Their numbers ... were quite beyond counting; but as it waned, a reckoning was attempted, from which it was computed, on the basis of that much-diminished rate, that 240,000 must have been visible during the nine hours they continued to fall."

The meteor storm made a deep and terrifying impression on the American people. According to newspaper reports almost everyone saw it, awakened either by the commotion in the streets or by the moving glare of fireballs shining into bedroom

windows. In 1878 the historian R. M. Devens listed it as one of the 100 most memorable events in U.S. history. "During the three hours of its continuance," he wrote, "the day of judgment was believed to be only waiting for sunrise, and, long after the shower had ceased, the morbid and superstitious still were impressed with the idea that the final day was at least only a week ahead. Impromptu meetings for prayer were held in many places, and many other scenes of religious devotion, or terror, or abandonment of worldly affairs, transpired, under the influence of fear occasioned by so sudden and awful a display."

Indeed, the 1833 shower has been credited with contributing to the intense religious revivals that swept the United States in the 1830s, which permanently influenced the national character and spread new sects and denominations that are well established on the American scene today.

The meteor storm burst upon a world largely ignorant of the possibility of meteor showers. Yet records examined afterward showed that the storm could have been anticipated, if not actually predicted. The fault lay as much with the astronomers of the era as with anyone. Up until only some years earlier, they had refused to believe that meteors -- those little streaks of light so commonly seen in the upper atmosphere -- could have any astronomical connection at all. But the shower of 1833 dispelled all doubts. Many observers clearly reported that the meteors seemed to radiate from a spot in Leo and that, as the constellation moved slowly westward during the night, the radiant point moved with it.

Let's re-read that second-to-last paragraph:

"Indeed, the 1833 shower has been credited with contributing to the intense religious revivals that swept the United States in the 1830s, which permanently influenced the national character and spread new sects and denominations that are well established on the American scene today.

Guess what else befell Christianity in the 1830's? That's right, the Rapture Theory, espousing that at any moment Jesus Christ will return and "take-up" His church, i.e. rapture them "out of here", up, up, and away into the clouds. This extremely dangerous doctrine perpetrated on Christians hailed from Glasgow Scotland, conceived in a vision seen through the eyes of a sick woman named Margaret McDonald. If you wish to research church history to document this fact, we recommend as a good beginning source, the book "The Incredible Cover-Up", by Dave McPherson, Omega Publications, Medford, Oregon.

Note: Isn't it also interesting that this year especially, the Rapture Theory has been promoted as never before, with the production and promotion of two new full-length feature films exceeding sales of 14,000,000 copies already? One is titled "Vanished".

So let's recap what we have learned so far.

1. The plan of salvation is written in the uncorrupted Zodiac in the heavens.
2. It begins in the constellation Virgo and ENDS in the constellation of Leo.
3. The constellation Leo, the sign consummating the triumph of the LION of Judah, has three main elements to it:
 - a. The serpent
 - b. The cup of wrath
 - c. The birds of prey
4. In the year 1833, on November 17th, 133 years ago, there was a mighty meteor storm streaming from the Constellation Leo, so profound that it contributed to religious revival in the Western Hemisphere "spreading new sects and denominations that are well established on the American scene today." This forerunner and type has set the precedent for the meaning of the Leonids sign. Paul Revere, are you ready?
5. On November 17, 1999, there was a mighty meteor shower streaming from the Constellation Leo, only this time is was predominately over the Middle East. Does it signify religious revival again? Yes it does, but this time because it happened in the generation of the "fig tree", AND in the location that we watchmen are to look for signs, i.e. Jerusalem, it means that the final religious revival brought about by the "moon" and the "fallen stars", is about to take place real soon, in that location. Let's look at some scriptures.

It should be common knowledge that "stars" are symbolic of the sons of God, in other words, angels. In Job 38:7 we find the "stars" singing for joy when God created this beautiful planet, and in Rev. 12:4 we see that the dragon [Satan], drew 1/3 of the stars [sons of God], away from the Father. That should be ample documentation (for common sense dictates that stars can't sing, and you don't gather stars together like marbles), but in case someone needs a stronger reference, here's Rev. 1:20:

Rev. 1:20

The mystery of the seven stars which thou sawest in my right hand, and the seven golden candlesticks. The seven stars are the angels of the seven churches: and the seven candlesticks which thou sawest are the seven churches.

So "stars" are angels, angelic beings, meaning all those who aren't down here on earth in flesh bodies, including those who haven't made the trip here yet (i.e. been born from above), and those who have made the trip and returned (Eccles. 12:7).

Did you know that Jesus Christ gave his disciples (us) the same exact 7 Seals found in the book of Revelation in the Olivet prophecy found in Mat. 24 and Mark 13? Here is His description of the sixth seal in Mark:

Mark 13:24

But in those days, after that tribulation, the sun shall be darkened,
and the moon shall not give her light,

[25] And the stars of heaven shall fall, and the powers that are in
heaven shall be shaken.

Now that you know the symbolism, you can go ahead and substitute the word "angels" for "stars" in verse 25 and re-read the verse. Pretty simple, isn't it? Notice also that there shall be a shake up in heaven when this occurs, because we'll show what that is!

Now, this next verse is extremely important, for it sets the "time", the "season", when these angels fall:

Mark 13:28

Now learn a parable of the fig tree; When her branch is yet tender,
and putteth forth leaves, ye know that summer is near:

They will fall during the generation of the "fig tree", which was set out on May 15, 1948 (Jer. 24). "This generation" of the fig tree, will not pass away until the "angels fall from heaven". In other words, there will be "Baby Boomers" who see these "fallen angels".

Here is the same event described by John in the Revelation (notice it is the 6th seal):

Rev. 6:12

And I beheld when he had opened the sixth seal, and, lo, there was
a great earthquake; and the sun became black as sackcloth of hair,
and the moon became as blood;

[13] And the stars of heaven fell unto the earth, even as a fig tree
casteth her untimely figs, when she is shaken of a mighty wind.

We are again given reference to the figs. But just who are these "stars" that will fall to the earth, being CAST to the earth as unripe figs out of season, i.e. falling to earth before harvest time, which is at the 7th Trump when our Lord returns? Remember? We already read it the last study. They are Satan's angels who are cast out with him.

Rev. 12:7

And there was war in heaven:

I'd call that a pretty good description of Christ's words in Mark 13:25 that we just read: "and the powers that are in heaven shall be shaken".

Rev. 12:7 (cont.) Michael and his angels fought against the dragon;
and the dragon fought and his angels

Michael will probably "shake the livin' daylights" out of Satan before he gives him the boot!

Rev. 12:9

And the great dragon was cast out, that old serpent, called the Devil,
and Satan, which deceiveth the whole world: he was cast out into the
earth, and his angels were cast out with him. ,

Yep, "the 'stars' of heaven shall fall"! Jesus Christ said so and you can be absolutely sure they are coming! And the great dragon will be cast out too!

Luke 10:18

And He said unto them, I beheld Satan as lightning fall from heaven.

Here's an interesting observation (not that it is a big deal, just interesting.) Did you know that the Hubble Space Telescope (HST), representing the finest eye's the world has to offer, SHUT DOWN the week of the Leonid meteor shower and therefore MISSED seeing it altogether? How ironic! Here are some quotes from the BBC News, Monday, November 15, 1999 (remember the Leonids were on the 17th):

Hubble shuts its eyes

By BBC News Online science editor Dr. David Whitehouse

The Hubble Space Telescope (HST) has shut itself down, preventing astronomers from making observations of the Universe.

It is a safety precaution triggered by the failure of another of the space observatory's gyroscopes.

HST has six gyros onboard, half of which must be operational to point the observatory accurately.

But one by one, three have failed and there have been indications for some months now that a fourth gyro would also cease working.

This is apparently what happened on Saturday.

Isn't that just remarkable? The world's eyes were shut. The world did not have any eyes to see. (Personally, I believe the spirit of slumber must have come over Hubble, know what I mean?) Of course

the Space Shuttle astronauts began repairing it on Dec. 22, 1999, the Winter Solstice, and NASA wanted them to return before New Years Eve to avoid any Y2K problems. (Goodness, you'd think at least the geniuses at NASA would be confident they are Y2K ready.) Well, it looks like Hubble missed another phenomenon too, the Big Full Moon on the Winter Solstice, which we will discuss shortly.

Anyway, on that night (New Year's Eve 2000) the world was celebrating the ushering in of a New Millennium. Many folks were partying and drinking and shaking rattles and blowing horns, totally unaware of the warning about the three woe trumpets of God, and that the heavens are declaring those final events leading up to the Triumphant Return of the Lion of Judah.

If you have studied the Book of Revelation then you know that the last three trumps are the "woe" trumps and correspond to the three constellations within Leo that we covered in the previous studies.

Trump five (5) culminates with the casting down of the fallen angels, those nephilim of Gen. 6, also described by the prophet Joel and the apostle John as "swarming locusts" to graphically illustrate the manner in which they spiritually devour and consume the souls of men. In the constellation Leo they are known as the birds of prey.

Trump six (6) begins with the casting down of the Serpent, that old dragon, Satan himself, who comes posing as Jesus, though he is the false messiah. In the constellation Leo he is also known as the serpent.

Trump seven (7) sounds the triumphant return of Jesus Christ, who brings with Him reward and eternal life for His saints and also pours out the cup of wrath upon the ungodly.

So what about you? Are you watching or partying? (I don't mean as a single event on New Years Eve, but rather as a life style.) Do you realize how many times we Christians have been told to be diligent and study, which means to "watch"? Jesus told us to watch. Here is what He said concerning the very days we are living in RIGHT NOW, the days just prior to His return:

Luke 21:34

And take heed to yourselves, lest at any time your hearts be overcharged with surfeiting, and drunkenness, and cares of this life, and so that day come upon you unawares.

Repeat the question. Are you watching or partying? Do you have time for God's Word or are you just a little too busy these days?

[35] For as a snare shall it come on all them that dwell on the face of the whole earth.

[36] Watch ye therefore, and pray always, that ye may be accounted worthy to escape all these things that shall come to pass, and to

stand before the Son of man.

So Jesus told us to watch.

So did Paul:

1 Thes. 5:6

Therefore let us not sleep, as do others; but let us watch and be sober.

So did Peter:

1 Peter 4:7

But the end of all things is at hand: be ye therefore sober, and watch unto prayer.

So did John in Rev. 3:2 to the church of Sardis, a church of non-watchers. And here's what he then said will happen if they don't watch:

Rev. 3:3

Remember therefore how thou hast received and heard, and hold fast, and repent. If therefore thou shalt not watch, I will come on thee as a thief, and thou shalt not know what hour I will come upon thee.

If we don't watch, then we won't know when the "hour" is upon us.

Note: Some would accuse us and say that the "watching" has nothing to do with the heavens as we have noted in these past few studies. True, there are many other things to watch, but remember the "wise" men knew from the star in the heavens that the first advent had taken place. Herod and company were clueless until the wise men made it known.

So let's do some more watching and move to the next Sign in the Heavens that took place last week on December 22, 1999, which just happened to be the Winter Solstice. What is the Winter Solstice anyway? In the northern hemisphere it is the day when the Sun is farthest south. The Winter Solstice marks the first day of the season of WINTER and is the shortest day of the year, which means it is the longest period of DARKNESS from Sunset to Sunrise. An event occurred this year on the Winter Solstice that hasn't happened since the U. S. Civil War and won't happen again in your or my lifetime.

Here's the report:

VERY SPECIAL FULL MOON DEC. 22

This year will be the first full moon to occur on the winter solstice, Dec. 22, 1999, commonly called the first day of winter. Since a full moon on the winter solstice occurred in conjunction with a lunar perigee (point in the moon's orbit that is closest to Earth) the moon will appear about 14% larger than it does at apogee (the point in it's elliptical orbit that is farthest from the Earth). Since the Earth is also several million miles closer to the sun at this time of the year than in the summer, sunlight striking the moon is about 7% stronger making it brighter. Also, this will be the closest perigee of the Moon of the year since the moon's orbit is constantly deforming. If the weather is clear and there is a snow cover where you live, it is believed that even car headlights will be superfluous.

On December 21st. 1866 the Lakota Sioux took advantage of this combination of occurrences and staged a devastating retaliatory ambush on soldiers in the Wyoming Territory

In laymen's terms it will be a super bright full moon, much more than the usual AND it hasn't happened this way for 133 years!

Our ancestors 133 years ago saw this. Our descendants 100 or so years from now will see this again.

Students of the Bible know that all prophecy pertaining to Satan and the children of darkness is given in "lunar" terminology, while prophecy pertaining to the children of light is given in "solar" terms. The moon therefore is representative of he who has no light of his own, the lunatic himself, that old serpent, the devil.

Did you see that Full Moon? I sure did. Was that sucker big and bright, or what? And it appeared very, very close! Hmmm.

In a final study on the "Signs in the Heavens" we will analyze what the Sign in the MOON of the Winter Solstice means, along with the Sign in the STARS (the Sign in Leo), and see what's ahead in the heavens for the year 2,000. Would you believe Full Blood Red Eclipses of the Moon and an unparalleled alignment of the planets? By the way, it takes both the sun and the moon to make an eclipse of either one.

Yes, Jesus Christ was right on in Luke 21:25! There actually ARE "Signs in the Sun and in the Moon and in the Stars."

Watching them is exciting, isn't it? And knowing His words are true, is comforting!

The last Leonid Meteor shower of major magnitude was the 1833 Leonid Storm which was 166 (from the year 1999) years ago (although there was a notable shower 33 years ago, in 1966). The last time there was a Full Moon on the Winter Solstice was 33 years later in 1866, which was 133 years ago (from

2000 AD)!

But you and I, living in the generation of the fig tree, have witnessed these two phenomena only 36 days (6 x 6) apart. Do you not find that amazing?

And that's just the beginning! There is much more to come as the incredible "Signs in the Heavens" continue in the year 2000. On January 21, 2000, occurred the first of three (3) Full Blood Red Lunar Eclipses, that beginning from this past summer of 1999 are each 6 months apart:

Let's look again at verse 12.

Rev. 6:12 And I beheld when he had opened the sixth seal, and, lo, there was a great earthquake; and the sun became black as sackcloth of hair, and the moon became as blood;

The phrase "the moon became as blood" means that the whole, or full moon became as the color of blood. (See note on "moon" in verse 12 of the Companion Bible)

Here's something for you to do. Go to the following website and check out when the next times the moon becomes as blood red.



<http://www.spirit.net.au/~minnah/LEO.html>

You might find it interesting that beginning from the summer of 1999 you can count approximately every 6 months and there will be a full "blood red" lunar eclipse. 6 months, eclipse, 6 months, eclipse, 6 months, eclipse. Check it out yourself! Don't take my word for it! The dates are:

January 21, 2000

July 16, 2000

January 9, 2001

You can also go to the U.S. Naval Observatory website and verify these dates. The link is <http://aa.usno.navy.mil/AA/data/docs/UpcomingEclipses.html>

One thing we didn't point out is that 5 months from the last full blood red lunar eclipse (after the last of the three 6's moons), there was a Total Eclipse of the Sun. That date was June 21, 2001. Go to the U.S. Naval Observatory and check it out! For those who have studied chapter 9 of the Book of Revelation and know that the reign of antichrist has been shortened to the time of the locusts, which is a 5 month period, this is certainly very interesting.

Now be WISE! We are NOT SETTING ANY DATES for the return of Jesus Christ or the entering in of the "little horn", i.e. the false messiah? But it is time to Wake Up and start WATCHING!! Jesus wasn't just telling a nice story, to be "the scripture reading for today is...", as they say. When He told us there would be Signs in the Sun and in the Moon and in the Stars, He meant it! And if you believe we are truly in that final generation, the generation of the "fig tree" planted on May 15, 1948, which we most certainly are, then these signs should come as no surprise, and we should not be dismayed (afraid or confused) at them, as are the heathen.

Jeremiah 10:2

Thus saith the LORD, Learn not the way of the heathen, and be not dismayed at the signs of heaven; for the heathen are dismayed at them.

And then of course there are the scoffers who say (in scoffing news reports and PBS documentaries) all things continue as from the beginning.

2 Peter 3:3

Knowing this first, that there shall come in the last days scoffers, walking after their own lusts, [4] And saying, Where is the promise of his coming? for since the fathers fell asleep, all things continue as they were from the beginning of the creation.

Finally, there was yet another stellar phenomenon on May 5, 2000 (5/5/2000), between the 1st and 2nd Full Lunar Eclipses. At that time there was a very unusual alignment of the planets. So you can expect to hear from the doomsayers, if you haven't already, more predictions and hype about the end of the world and/or of major earthquakes, storms, high tides, etc. Here is a computer simulation of the alignment from the program Skylab.

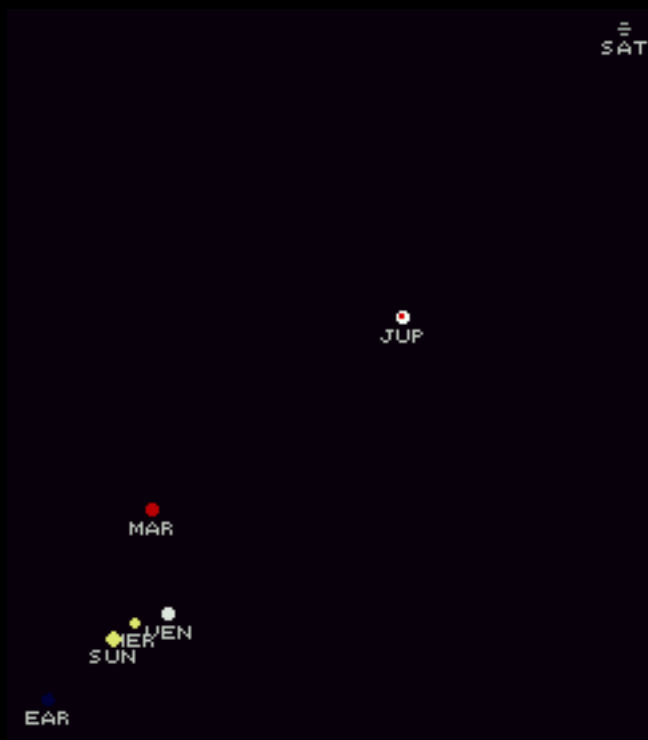

May 5, 2000

We will discuss more about this major solar system event in the coming months. Until then, let me ask you a question. Don't they will look like 7 eyes up in the sky? We often hear the expression before someone does something or takes action that "he is getting all his ducks in a row". It sure looks like our Father is getting all His planets in a row, doesn't it?

So what do we say then? What do all these Signs in the Heavens mean?

Well, just as Paul Revere in his day knew that the enemy was coming, we, the children of light, who have been sealed with the knowledge of His Word also know that the enemy is coming, don't we? Of course if you believe Jesus Christ can return at any moment and rapture you away, then don't even worry about it, because you don't need any signs. You're just waiting for the Big Surprise!

And just like Paul Revere, we were told that there would be signs, no doubt about it! His was to be in the tower of the Old North Church, while ours are to be in the towering Heavens.

When Paul Revere saw the sign did he run and hide and try to save his own neck? No he did not! He mounted his horse and rode through the towns and countryside and WARNED HIS PEOPLE that the enemy was coming. He was a true watchman indeed.

We are now are beginning to see those signs we were to Watch for. What do you suppose we are to do... run and hide and try to save our own necks? No, saving your own neck is the rapture theory! We must throw down our pots and pans and get riding through the towns and countryside!

The enemy, the desolator, is coming for to destroy, to make desolate the souls of our people, to inflict a spiritual death. There was a Full Moon, even a Harvest Moon, that just occurred on the Winter Solstice. It is a sign that there is a harvest SOON coming, not in the true harvest time, but before the true harvest time, IN THE WINTER, i.e. out of season! But most people will think that it is truly the right harvest time and they will be harvested out of season, taken first in the field, and will be married to the wrong Jesus, the instead-of-Jesus, antichrist himself!

Jesus warned us in Mat. 24 and Mark 13 to make sure that we avoid that winter harvest like the plague, and stay away from the False Shepherd and his Phony Reapers! When we see him in Judea, standing in the holy place claiming to be Jesus Christ, stay away from him. He's big trouble!

Mark 13:18

And pray ye that your flight be not in the winter.

[19] For in those days shall be affliction, such as was not from the beginning of the creation which God created unto this time, neither shall be.

So are you one of God's elect, a disciple of Jesus Christ? Do you have eyes to see and ears to hear? Was Jesus talking to you when he said to WATCH in Luke 21? Do the apostle Paul's instructions to watch apply to you? Do Peter's, do John's? If so, then you are a watchman and the following words are for you:

Ezekiel 33:2

Son of man, speak to the children of thy people, and say unto them, When I bring the sword upon a land, if the people of the land take a man of their coasts, and set him for their watchman:

[3] If when he seeth the sword come upon the land, he blow the trumpet, and warn the people;

4] Then whosoever heareth the sound of the trumpet, and taketh not warning; if the sword come, and take him away, his blood shall be upon his own head. [5] He heard the sound of the trumpet, and took not warning; his blood shall be upon him.

Paul Revere warned the people. If they didn't take up the arm and heed the warning then it was their own fault!

[5 cont.] But he that taketh warning shall deliver his soul.

If they did heed the warning then they saved their lives. But either way, the watchmen did his job! He warned the people and then it was up to them!

But what if the watchman does nothing?

Ezek. 33:6

But if the watchman see the sword come, and blow not the trumpet, and the people be not warned; if the sword come, and take any person from among them, he is taken away in his iniquity; but his blood will I require at the watchman's hand.

Let there be no doubt that the watchman, if he/she SEES, has a responsibility to the people, and therefore to God.

[7] So thou, O son of man, I have set thee a watchman unto the house of Israel; therefore thou shalt hear the word at my mouth, and warn them from me.

Again, what do watchmen do? They watch for the enemy and the signs of his coming! How did Paul Revere know that the enemy was coming? He was given the sign.

We have been given strong signs that the Moon and his Leonids (their names from the news), the Serpent and his Birds of Prey (their names from the constellation Leo), Satan and his angels (their names from Rev. 12:9), are close at hand and the Winter Harvest of the night is soon upon us. If you have eyes to see and ears to hear and therefore have "heard the word at His mouth", and not from the mouth of men only, and so have an understanding of His plan, then He has "set you as a watchman" and you are to warn His people from Him, i.e. from His Word.

May God Richly Bless each and every one of you.

His knight,
Lancelot

Edited for content and proper dating. FDG

[INDEX](#)

[HOME](#)

[CHRISTIAN LINKS](#)

Let's find out exactly what our Christmas day, December 25th, really is. This first section will give you the starting time frames.

APPENDIX 179; Bullinger's Companion Bible

I. PARALLEL DATINGS OF THE TIMES OF OUR LORD

II. DATES OF "THE BEGETTING" AND THE NATIVITY

III. "THE COURSE OF ABIA"

A.M.= Anno Mundi ; i.e. in the year of the world. B.C.= Before Christ. Reckoned as from 4004 A.M.
A.C.= Anno Christi ; i.e. in the year of Christ. Reckoned from the Nativity, in 4000 A.M. and 749-750 A.U.C.
A.U.C.= Anno Urbis conditoe ; i.e. in the year in which the City (Rome) was founded.

	A. M.		B. C.- A. D.		A.C.		A. U. C					
	3960		44				9					
	1		43				710					
	2		42				11					
	3		41				12					
	4		40				13					
	5		39				14	Herod declared king by the Romans, according to Josephus	(Ant. xvii. 8 &1), who states that his death took place thirty-seven years later,	and as he always reckoned his years from Nisan to Nisan	(including initial and terminal fractions of Nisan as complete years),	the death of Herod would be in 749-750 A.U.C., or 4-3 B.C.
	6		38				15					
	7		37				16					

	8		36				17					
	9		35				18					
	3970		34				19					
	1		33				720					
	2		32				21		Years of the Reign of Augustus (Octavius).			
	3	Battle of Actium	31				722		1st	year of Octavius.		
	4		30	Decree of Senate of Rome			23		2			
	5		29				24		3			
	6		28				25		4			
	7		27				26		5	Augustus (Octavia) Imperator.		
	8		26				27		6			
	9		25				28		7			
	3980		24				29		8			
	1		23				730		9			
	2		22				31		10			
	3		21				32		11			
	4		20				33		12			
	5		19				34		13			

	6		18				35		14			
	7		17				36		15			
	8		16				37		16			
	9		15				38		17			
	3990		14				39		18			
	1		13				740		19			
	2		12				41		20			
	3		11				42		21			
	4		10				43		22			
	5		9				44		23			
	6		8				45		24			
	7		7				46		25			
	8		6				47		26			
	9		5		Years of the Age of the Lord		48		27			
(See Ap.50)	4000	The Nativity	4	}Quirinus'	0		749	Herod d.c. end of Jan. 3 B.C.	28	Our Lord b. 15th Tisri =29th Sept. 4 B. C.		
	1	{1st taxing or Census--	3	}First	1		750		29			
	2	Luke 2:2}	2	} Governorship.	2		51		30			

	3		1		3		52		31			
	4004		0 A. D.		4		753		32	A.D. reckoning begins, owing to the mistake of <i>Dionysus</i>	<i>Exiguus</i> , in arranging the Calendar of the	Christian Era in A. D. 532
	5		1		5		54		33			
	6		2		6		55		34			
	7		3		7		56		35			
	8		4		8		57		36			
	9		5		9		58		37			
	4010		6		10		58		38			
	1		7		11		760		39			
	2		8	Christ in	12	the Temple.	61		40			
	3		9		13		62		41			
	4	2nd Census (?)	10		14		63		42			
	5		11		15		64		43		Years of the Reign of Tiberius	
	6		12		16		65		44	1st year of Tiberius'	1	joint reign with Augustus.
	7		13		17		66		45		2	
	8		14		18		67	19th August	46	Augustus Dies.	3	

	9		15		19		68				4	
	4020		16		20		69				5	
	1		17		21		770				6	
	2		18		22		71				7	
	3		19		23		72				8	
	4		20		24		73				9	
	5		21		25		74				10	
	6		22		26		75				11	
	7		23		27		76				12	
	8	3rd Census (?)	24		28		77				13	3rd Census this year (?).
	9		25		29		78				14	
	4030	The Ministry	26	of our	30	Lord	779	begins	(Luke 3:23)	in the	15th	year of Tiberius.
	1		27		31		780				16	
	2		28		32		81				17	
ANNO MUNDI	4033	The Crucifixion	29 A. D.	The Lord	33	Years of Age	782	A.U.C. Roman Reckoning.		The	18th	year of Tiberius.

1. ZUMPT fixes Quirinus' (Cyrenius') First Governorship as 4 B.C. to 1 B.C. Justin Martyr thrice says that our Lord was born under Quirinus (Apol.1.XXXIV, p.37; XLVI, p. 46; Dial. LXXVIII, p. 195. Clark's ed.).

2. According to some, Augustus died August 19, A.D. 14. Therefore if Tiberius' co-regnancy was for two years before Augustus' death his first year was 765 A.U.C. = 12 A.D. His fifteenth year consequently was A.U.C. 779 = 26 A.D. = 4030 A.M. and A.C. 30. for our Lord was thirty years of age when He began His Ministry (Luke 3:23). Clement of Alexandria gives the years of Augustus' reign as being 43-46, according to different reckonings in his day.

3. According to Clement of Alexandria (c. A.D. 190-220) "Our Lord was born in the twenty-eighth year when first the census was taken every fourteen years, then the next would fall in A.D. 10, and the succeeding one would have been due A.D.24.

Let's continue exploring God's Word !

II. DATES OF "THE BEGETTING" OF OUR LORD AND HIS BIRTH.

(Luke 2:7. John 1:-14.)(*he gennesis*, Matt.1:18, 20 (see R.V. marg.). John 1:14-)

280 days= 40 weeks--forty *sevens*, the *perfect* period of human gestation [7x5x8=280].

The Component Numbers of 280 are highly *significant* in *this connection*.

7 denotes Spiritual Perfection.

5 denotes Divine Grace.

8 denotes Resurrection, Regeneration, &c. (Ap. 10).

1st TEBETH=25th December (5 B. C.).

15th ETHANIM=29th September (4 B. C.).

From 1st TEBETH to 15th ETHANIM (inclusive)=280 days.

From 25th December (5 B. C.) to 29th September (4 B. C.)=280 days.

NEXT



Appendix 179 (cont.), E.W. Bullinger; The Companion Bible

II. DATES OF "THE BEGETTING" (*he genesis*, Matt.1:18, 20 (see R.V. marg.). John 1:14) OF OUR LORD AND HIS BIRTH. (Luke 2:7. John 1:-14.)

				78 78			156 156			234 234	
TEBETH	1=25- 26	Dec. (5B.C.).		20=12- 13			10=29- 30			29=15-16	
(29)	2=26- 27	(7)		21=13- 14			11=30- 31			30=16-17	
	3=27- 28			22=14- 15			12=31- 1		ELUL	1=17-18	
	4=28- 29			23=15- 16			13=1-2	June	(29)	2=18-19	
	5=29- 30			24=16- 17			14=2-3	(30)		3=19-20	
	6=30- 31			25=17- 18			15=3-4			4=20-21	
	7=31-1			26=18- 19			16=4-5			5=21-22	
	8=1-2	Jan. (4B. C.).		27=19- 20			17=5-6			6=22-23	
	9=2-3	(31)		28=20- 21			18=6-7			7=23-24	
	10=3-4			29=21- 22			19=7-8			8=24-25	
	11=4-5		NISAN	1=22- 23			20=8-9			9=25-26	
	12=5-6		(30)	2=23- 24			21=9- 10			10=26-27	
	13=6-7			3=24- 25			22=10- 11			11=27-28	
	14=7-8			4=25- 26			23=11- 12			12=28-29	
	15=8-9			5=26- 27			24=12- 13			13=29-30	

	16=9-10			6=27-28			25=13-14			14=30-31	
	17=10-11			7=28-29			26=14-15			15=31-1	September
	18=11-12			8=29-30			27=15-16			16=1-2	(29)
	19=12-13			9=30-31			28=16-17			17=2-3	
	20=13-14			10=31-1			29=17-18			18=3-4	
	21=14-15			11=1-2	April		30=18-19			19=4-5	
	22=15-16			12=2-3	(30)	THAMMUZ	1=19-20			20=5-6	
	23=16-17			13=3-4		(29)	2=20-21			21=6-7	
	24=17-18			14=4-5			3=21-22			22=7-8	
	25=18-19			15=5-6			4=22-23			23=8-9	
	26=19-20			16=6-7			5=23-24			24=9-10	
	27=20-21			17=7-8			6=24-25			25=10-11	
	28=21-22			18=8-9			7=25-26			26=11-12	
	29=22-23			19=9-10			8=26-27			27=12-13	
SEBAT	1=23-24			20=10-11			9=27-28			28=13-14	
(30)	2=24-25			21=11-12			10=28-29			29=14-15	
	3=25-26			22=12-13			11=29-30		ETHANIM (TISRI)	1=15-16	
	4=26-27			23=13-14			12=30-1		(15)	2=16-17	
	5=27-28			24=14-15			13=1-2	July		3=17-18	

6=28-29			25=15-16			14=2-3	(31)		4=18-19	
7=29-30			26=16-17			15=3-4			5=19-20	
8=30-31			27=17-18			16=4-5			6=20-21	
9=31-1			28=18-19			17=5-6			7=21-22	
10=1-2	February		29=19-20			18=6-7			8=22-23	
11=2-3	(29)		30=20-21			19=7-8			9=23-24	
12=3-4	(Leap Year)	ZIF	1=21-22			20=8-9			10=24-25	
13=4-5		(29)	2=22-23			21=9-10			11=25-26	
14=5-6			3=23-24			22=10-11			12=26-27	
15=6-7			4=24-25			23=11-12			13=27-28	
16=7-8			5=25-26			24=12-13			14=28-29	
17=8-9			6=26-27			25=13-14		ETHANIM or TISRI	15=29-30	September
18=9-10			7=27-28			26=14-15		Days on Jewish reckoning.	280 280	Days on Gentile reckoning.
19=10-11			8=28-29			27=15-16				
20=11-12			9=29-30			28=16-17				
21=12-13			10=30-1			29=17-18			According to Jewish reckoning.	
22=13-14			11=1-2	May	AB	1=18-19		TEBETH	29	days.
23=14-15			12=2-3	(31)	(30)	2=19-20		SEBAT	30	
24=15-16			13=3-4			3=20-21		ADAR	29	

	25=16-17			14=4-5			4=21-22		NISAN	30	
	26=17-18			15=5-6			5=22-23		ZIF	29	
	27=18-19			16=6-7			6=23-24		SIVAN	30	
	28=19-20			17=7-8			7=24-25		THAMMUZ	29	
	29=20-21			18=8-9			8=25-26		AB	30	
	30=21-22			19=9-10			9=26-27		ELUL	29	
ADAR	1=22-23			20=10-11			10=27-28		ETHANIM	15	
(29)	2=23-24			21=11-12			11=28-29			280	
	3=24-25			22=12-13			12=29-30				
	4=25-26			23=13-14			13=30-31				
	5=26-27			24=14-15			14=31-1			According to Gentile (Western) reckoning.	
	6=27-28			25=15-16			15=1-2	August	December	7	days.
	7=28-29			26=16-17			16=2-3	(31)	January	31	
	8=29-1			27=17-18			17=3-4		February	29	
	9=1-2	March		28=18-19			18=4-5		March	31	
	10=2-3	(31)		29=19-20			19=5-6		April	30	
	11=3-4		SIVAN	1=20-21			20=6-7		May	31	
	12=4-5		(30)	2=21-22			21=7-8		June	30	

	13=5-6			3=22-23			22=8-9		July	31	
	14=6-7			4=23-24			23=9-10		August	31	
	15=7-8			5=24-25			24=10-11		September	29	
	16=8-9			6=25-26			25=11-12			280	
	17=9-10			7=26-27			26=12-13				
	18=10-11			8=27-28			27=13-14				
	19=11-12			9=28-29			28=14-15				
	78 78			156 156			234 234				

280 days= 40 weeks--forty *sevens*, the *perfect* period of human gestation [7x5x8=280].

The Component Numbers of 280 are highly *significant* in *this connection*.

7 denotes Spiritual Perfection.

5 denotes Divine Grace.

8 denotes Resurrection, Regeneration, &c. (Ap. 10).

1st TEBETH=25th December (5 B. C.).

15th ETHANIM=29th September (4 B. C.).

From 1st TEBETH to 15th ETHANIM (inclusive)=280 days.

From 25th December (5 B. C.) to 29th September (4 B. C.)=280 days.

1. It thus appears without the shadow of a doubt that the day assigned the the *Birth* of the Lord, viz. December 25, was the day on which He was "begotten of the Holy Ghost", i.e. by *pneuma hagian* = divine power (Matt. 1:18, 20 marg.), and His birth took place on the 15th of *Ethanim*, September 29, in the year following, thus making beautifully clear the meaning of John 1:14, "The Word *became flesh*" (Matt. 1:18, 20) on the 1st *Tebeth* or December 25 (5 B.C.), "and *tabernacled* (Gr. *eskeno-sen*) with us", on 15th of *Ethanim* or September 29 (4 B.C.).

The 15th of *Ethanim* (or *Tisri*) was the *first* day of the Feast of Tabernacles. The circumcision therefore took place on the *eighth* day of the Feast = 22nd *Ethanim* = October 6-7 (Lev. 23:33-34). So that these two momentous events fall into their proper place and order, and the *real reason* is made clear why the 25th of December is associated with our Lord and was set apart by the Apostolic Church to commemorate the stupendous event of the "Word becoming flesh" - and not, as we have for so long been led to suppose, the commemoration of a pagan festival.

2. An overwhelmingly strong argument in favor of the correctness of this view lies in the fact that the *date* of "the Festival of Michael and All Angels" has been from very early times the 29th day of September, on Gentile (Western) reckoning.

But "the Church" even then had lost sight of the reason why this date rather than any other in the Calendar should be so indissolubly associated with the great Angelic Festival.

The following expresses the almost universal knowledge or rather want of knowledge of "Christendom" on the subject: "We pass on now to consider, in the third place, the commemoration of September 29, the festival of Michaelmas, *par excellence*. It does not appear at all certain what was the *original* special idea of the commemoration of this day" (Smith's *Dict. of Chr. Antiqq.* (1893), vol. ii, p. 1177 (3)).

A reference, however, to the Table and statements above, makes the "*original* special idea " why the Festival of "Michael and All Angels" is held on September 29 abundantly clear. Our Lord was *born* on that day, the first day of the "Feast of Tabernacles" (Lev. 23:39). This was on the *fifteenth* day of the seventh Jewish month called *Tisri*, or *Ethanim* (Ap. 51. 5), corresponding to our September 29 (of the year 4 B.C.)

The "Begetting" (*genesis*) Day of the Lord was announced by the Angel Gabriel. See notes on Dan. 8:16 and Luke 1:19.

The "Birth" Day, by "(the) Angel of the Lord", unnamed in either Matthew and Luke.

That this Angelic Being was "Michael the Archangel (of Jude 9), and *Mika'el hassar haggadol* - "Michael the Great Prince"- of Dan. 12:1, seems clear for the following reason: If, "when *again* (yet future) He bringeth the First-begotten into the world, He saith, Let *all* the Angels of God worship Him" (Heb 1:6; quoting Ps. 97:6) - then this must include the great Archangel Michael himself. By parity of reasoning, on the *First* "bringing" into the world of the only begotten Son, the Archangel must have been present. And the tremendous announcement to the shepherds, that the Prince of Peace (Isa. 9:6) was on earth in the person of the Babe of Bethlehem, must therefore have been made by the same head of the heavenly host (Luke 2:9-14). In mundane affairs, announcements of supremest importance (of kings, &c.) are invariably conveyed through the most exalted personage in the realm. The point need not be labored.

3. The fact of the Birth of our Lord having been revealed to the shepherds by the Archangel Michael on the 15th of *Tisri* (or *Ethanim*), corresponding to September 29, 4 B.C. - the *first* day of the Feast of Tabernacles - must have been known to believers in the Apostolic Age. But "the mystery of iniquity" which was "already working" in Paul's day (2Thess. 2:7) quickly enshrouded this and the other great fact of the day of the Lord's "begetting" on the first day of the Jewish month *Tebeth* (corresponding to December 25, 5 B.C.) - as well as other events connected with His sojourn on earth, (*1) - in a rising mist of obscurity in which they have ever since been lost.

The earliest allusion to December 25 (modern reckoning) as the date for the Nativity is found in the *Stromata* of Clement of Alexandria, about the beginning of the *third* century A.D. (See note 3 p. 197). (*2)

That "Christmas" was a pagan festival long before the time of our Lord is beyond doubt. In Egypt Horus (or Harpocrates (*3), the son of Isis (Queen of Heaven), was born about the time of winter solstice. (*4) By the time of the early part of the fourth century A.D., the *real* reason for observing Christmas as the date for the miraculous "begetting" of Matt. 1:18 and "the Word becoming flesh" of John 1:14 had been lost sight of. The policy of Constantine, and his *Edict of Milan*, by establishing universal freedom of religion furthered this. When many of the followers of the old pagan systems - the vast majority of the empire, it must be remembered - adopted the Christian religion as a cult, which Constantine had made fashionable, and the "Church" became the Church of the Roman Empire, they brought in with them, among a number of other things emanating from Egypt and Babylon, the various Festival Days of the old "religions". Thus "Christmas Day," the *birthday* of the Egyptian Horus (Osiris), became gradually substituted for the real *Natalis Domini* of our blessed Savior, viz. September 29, or *Michaelmas Day*.

4. If however, we realize that the center of gravity, so to speak, of what we call the Incarnation if the *Incarnation itself*- the wondrous fact of the Divine "begetting", when "the Word *became* flesh" (see notes on Matt. 1:18 and John 1:14) - and that this is to be associated with December 25, instead of March - as for 1,600 years Christendom has been led to believe - then, "Christmas" will be seen in quite another light, and many who have hitherto been troubled with scruples concerning the day being, as they have been taught, the anniversary of a Pagan festival, will be enabled to worship on that Day without alloy of doubt, as the time when the stupendous miracle which is the foundation stone of the Christian faith, came to pass.

The "Annunciation" by the Angel Gabriel marked the *genesis* of Matt. 1:18, and the first words of John 1:14.

The announcement to the shepherds by the Archangel Michael marked the Birth of our Lord. John 1:14 is read as though "the Word became flesh (R.V.) and dwelt among us ", were one and the same thing, whereas they are *two* clauses. The paragraph should read thus:

"And the Word became flesh;(Gr. *ho logos sarz egeneto.*) And tabernacled with (or among) us." (Gr. *kai eskenosen en hemin*).

The word *tabernacled* here (preserved in R.V. marg.) receives beautiful significance from the knowledge that "the Lord of glory" was "*found* in fashion as a man", and thus *tabernacling* in human flesh. And in turn it shows in equally beautiful significance that our Lord was born on the first day of the great Jewish Feast of *Tabernacles*, viz. the 15th of Tisri, corresponding to September 29, 4 B.C. (modern reckoning). The Circumcision of our Lord took place therefore on the *eighth* day, the last day of the Feast, the "Great Day of the Feast" of John 7.37 ("Tabernacles" had eight days. The Feast of Unleavened Bread had seven days and Pentecost one. See Lev. 23)

5. The main arguments *against* the Nativity having taken place in December may be set forth very simply:

(i) The extreme improbability, amounting almost to impossibility, that Mary, under such circumstances, could have undertaken a journey of about 70 miles (as the crow flies), through a hill district averaging some 3,000 feet above sea-level, in the depth of winter:

(ii) Shepherds and their flocks would not be found "abiding" (Gr. *agrauleo*) in the open fields at night in December (Tebeth), for the paramount reason that there would be no pasturage at that time. It was the custom then (as now) to withdraw the flocks during the month *Marchesvan* (Oct.-Nov.) (**1) from the open districts and house them for the winter.

(iii) The Roman authorities in imposing such a "census taking" for the hated and unpopular "foreign" tax would not have enforced the imperial decree (Luke 2:1) at the most inconvenient and inclement season of the year, by compelling the people to enroll themselves at their respective "cities" in December. In such a case they would naturally choose the "line" of least resistance" and select a time of year that would cause least friction, and interference with the habits and pursuits of the Jewish people. This would be in the autumn, when the agricultural round of the year was complete, and the people generally more or less at liberty to take advantage, as we know many did, of the opportunity of "going up" to Jerusalem for the "Feast of Tabernacles" (cp. John 7:8-10, &c), the crowning Feast of the Jewish year.

To take advantage of such a time would be to the Romans the simplest and most natural policy, whereas to attempt to enforce the Edict of Registration for the purpose of Imperial taxation in the depth of winter,- when traveling for such a purpose would have been deeply resented, and perhaps have brought about a revolt,- would never have been attempted by such an astute ruler as Augustus.

6. With regard to the other two "Quarter Days", June 24, March 25, these are both associated with the miraculous (Luke 1:7) "conception" and birth of the Forerunner, as December 25 and September 29 are with our Lord's miraculous "Begetting" and Birth; and are therefore connected with "the Course of Abiah."

(*1) Notably the day of the crucifixion, &c. (see Ap. 156, 165).

(*2) His statements are, however, very vague, and he mentions several dates claimed by others as correct.

(*3) Osiris reincarnated.

(*4) See Wilkinson's *Ancient Egyptians*, Vol. III, p.79 (Birch's ed.).

(**1) It is true that the Lebanon shepherds are in the habit of keeping their flocks alive during the winter months, by cutting down branches of trees in the forests in that district, to feed the sheep on the leaves and twigs, when in autumn the pastures are dried up, and in winter, when snow covers the ground. (cp. *Land and Book*, p.204), but there is no evidence that the Bethlehem district was afforested in this manner.

III. "THE COURSE OF ABIA" (Luke 1:5).

This was the *eighth* of the priestly courses of ministration in the Temple (I Chron. 24:10), and occurred, as did the others, twice in the year.

The "Courses" were changed every week, beginning each with a Sabbath. The reckoning commenced on the 22nd day of Tisri or Ethanim (Ap. 51. 5). This was the eighth and last day of the Feast of Tabernacles = the "Great Day of the Feast" (John 7:37), and was a Sabbath (Lev. 23:39)

The first course fell by lot to Jehoiarib, and the eighth to Abia or Abijah (1Chron. 24:10).

Bearing in mind that *all* the courses served together at the three Great Feasts, the dates for the two yearly "ministrations" of Abiah will be seen to fall as follows:

The first (*1) ministration was from 12 - 18 Chisleu = December 6 - 12.

The second ministration was from 12 -18 Sivan = June 13 - 19.

The announcement therefore to Zacharias in the Temple as to the conception of John the Baptist took place between 12 - 18 SIVAN (June 13 -19), in the year 5 B.C. After finishing his "ministration", the aged priest "departed to his own house" (Luke 1:23) which was in a city (*2) in "the hill country" of Juda (verse 39).

The day following the end of the "Course of Abia" being a Sabbath (Sivan 19), he would not be able to leave Jerusalem before the 20th.

The thirty miles journey would probably occupy, for an old man, a couple of days at least. He would therefore arrive at his house on the 21st or 22nd. This leaves ample time for the miraculous "conception" of Elizabeth to take place on or about the 23rd of Sivan (*3) - which would correspond to June 23 -24 of that year. The fact of the conception and *it's date* would necessarily be known at the time and afterwards, and hence the 23rd of SIVAN would henceforth be associated with the conception of John the Baptist as the 1st of TEBETH would be with that of our Lord.

But the same influences that speedily obscured and presently obliterated the real dates of our Lord's "Begetting" and Birth, were also at work with regard to those of the Forerunner, and with the same results. As soon as the true *Birth* day of Christ had been shifted from its proper date, viz. the 15th of Tisri (September 29), and a Festival Day from the Pagan Calendars substituted for it (viz. December 25), then everything else had to be altered too.

Hence "Lady Day" in association with March 25 (new style) became necessarily connected with the Annunciation. And June 24 made its appearance as it still is in our Calendar, as the date of "the *Nativity* of John the Baptist", instead of , as it really is, the date of his miraculous conception.

The Four "Quarter Days" may therefore be set forth thus: first in the chronological order of the events with which they are associated, viz.:

The Conception of John Baptist	on or about	23rd SIVAN	=	June 24	in the year	5 B.C.
The Gennesis (Begetting) of our Lord	on or about	1st TEBETH	=	December 25	in the year	5 B. C.
The birth of John Baptist	on or about	4th-7th NISAN	=	March 25-28	in the year	4 B. C.
The birth of our Lord	on or about	15th TISRI	=	September 29	in the year	4 B. C.

or, placing the two sets together naturally :

The conception of John	23rd SIVAN	=	June 23-24	in the year	5 B. C.
The birth of John	7th NISAN	=	March 28-29	in the year	4 B. C.

The Miraculous "Begetting"	1st TEBETH	=	December 25	in the year	5 B. C.
The NATIVITY	15th TISRI	=	September 29	in the year	4 B. C.

(*1) Reckoning of course from *Ethanim* or *Tisri* - the *First* month of the civil year. The sacred year was six months later, and began on 1st *Nisan*.

(*2) The "city" is not named (possibly *Juttah*, some 30 miles to the south of Jerusalem).

(*3) The conception of John the Baptist was, in view of Luke 1:7, as miraculous as that of Isaac; but it is not necessary to insist upon the complete period of *forty sevens* (p.198) in the case of Elizabeth. Therefore the birth of the Forerunner may have been three or four days short of the full two hundred and eighty days, - as indicated in the above table.

[Back to Christian Links](#)

- E N D -